

- ▼ High Input Impedance
- ▼ High Peak Current Capability
- ▼ Low Gate Drive
- ▼ Strobe Flash Applications

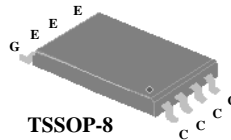

V_{CE}	400V
I_{CP}	150A

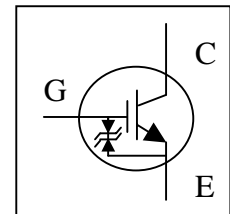

Absolute Maximum Ratings

Symbol	Parameter	Rating	Units
V_{CE}	Collector-Emitter Voltage	400	V
V_{GE}	Peak Gate-Emitter Voltage	± 6	V
I_{CP}	Pulsed Collector Current, $V_{GE} @ 2.5V$	150	A
$P_D @ T_A = 25^\circ C^1$	Maximum Power Dissipation	1	W
T_{STG}	Storage Temperature Range	-55 to 150	$^\circ C$
T_J	Operating Junction Temperature Range	150	$^\circ C$

Electrical Characteristics @ $T_j = 25^\circ C$ (unless otherwise specified)

Symbol	Parameter	Test Conditions	Min.	Typ.	Max.	Units
I_{GES}	Gate-Emitter Leakage Current	$V_{GE} = \pm 6V, V_{CE} = 0V$	-	-	± 10	μA
I_{CES}	Collector-Emitter Leakage Current	$V_{CE} = 400V, V_{GE} = 0V$	-	-	10	μA
$V_{CE(sat)}$	Collector-Emitter Saturation Voltage	$V_{GE} = 2.5V, I_{CP} = 150A$ (Pulsed)	-	5.2	9	V
$V_{GE(th)}$	Gate Threshold Voltage	$V_{CE} = V_{GE}, I_C = 250\mu A$	0.3	-	1.2	V
Q_g	Total Gate Charge	$I_C = 40A$	-	76	130	nC
Q_{ge}	Gate-Emitter Charge	$V_{CE} = 200V$	-	4	-	nC
Q_{gc}	Gate-Collector Charge	$V_{GE} = 4V$	-	26	-	nC
$t_{d(on)}$	Turn-on Delay Time	$V_{CC} = 320V$	-	220	-	ns
t_r	Rise Time	$I_C = 160A$	-	800	-	ns
$t_{d(off)}$	Turn-off Delay Time	$R_G = 10\Omega$	-	1.6	-	μs
t_f	Fall Time	$V_{GE} = 4V$	-	1.5	-	μs
C_{ies}	Input Capacitance	$V_{GE} = 0V$	-	4485	8240	pF
C_{oes}	Output Capacitance	$V_{CE} = 30V$	-	44	-	pF
C_{res}	Reverse Transfer Capacitance	$f = 1.0MHz$	-	40	-	pF
R_{thJA}^1	Thermal Resistance Junction-Ambient		-	-	125	$^\circ C/W$

Notes:

1. Surface mounted on 1 in² copper pad of FR4 board.

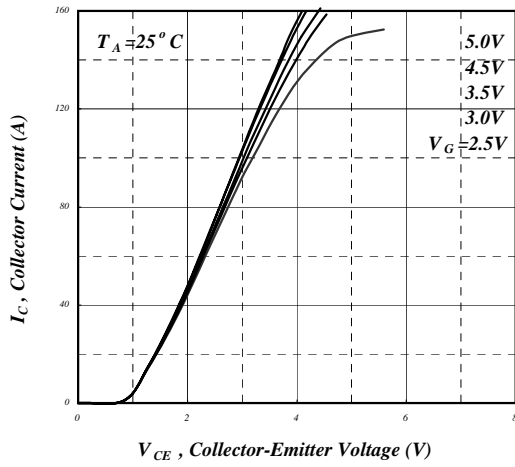

Fig 1. Typical Output Characteristics

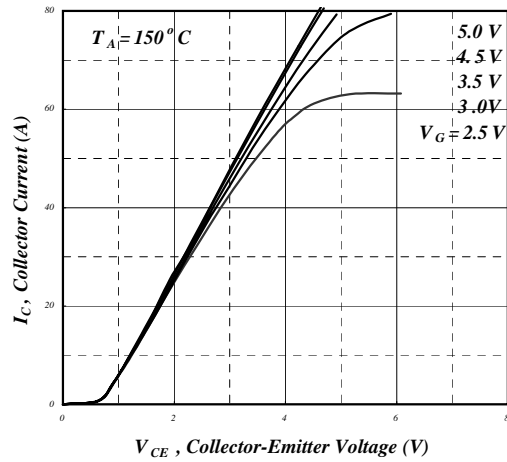

Fig 2. Typical Output Characteristics

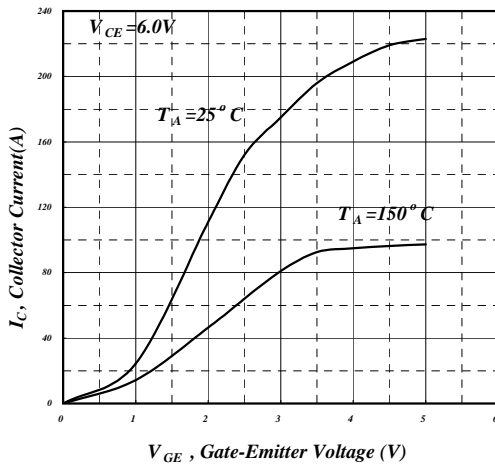

Fig 3. Collector Current v.s. Gate-Emitter Voltage

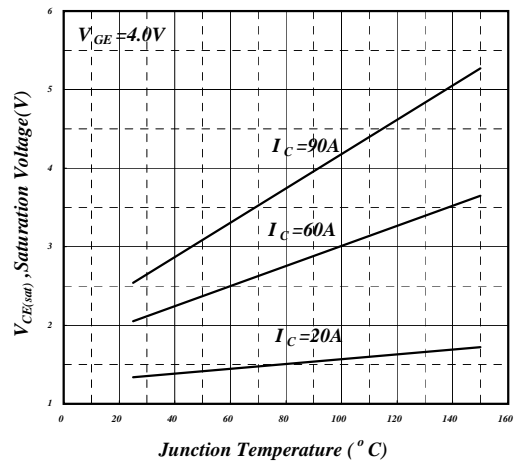

Fig 4. Collector- Emitter Saturation Voltage v.s. Junction Temperature

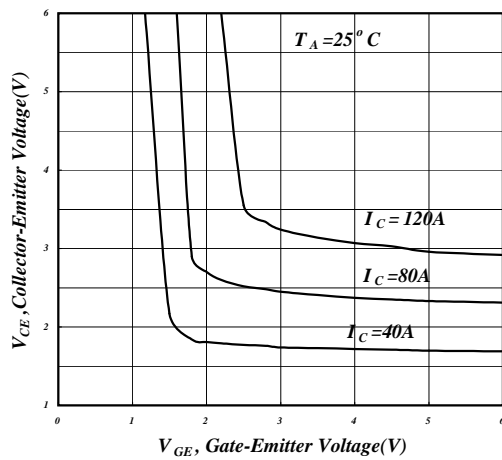

Fig 5. Collector Current v.s. Gate-Emitter Voltage

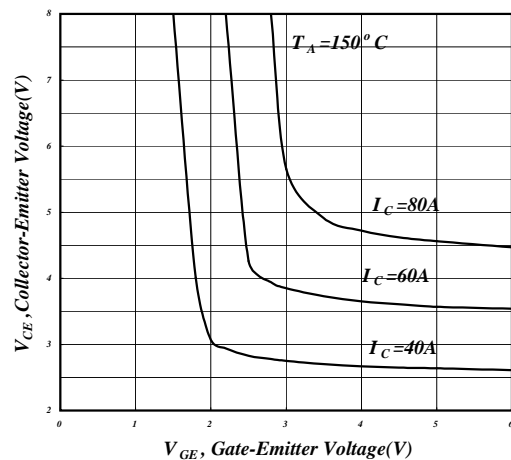

Fig 6. Collector Current v.s. Gate-Emitter Voltage

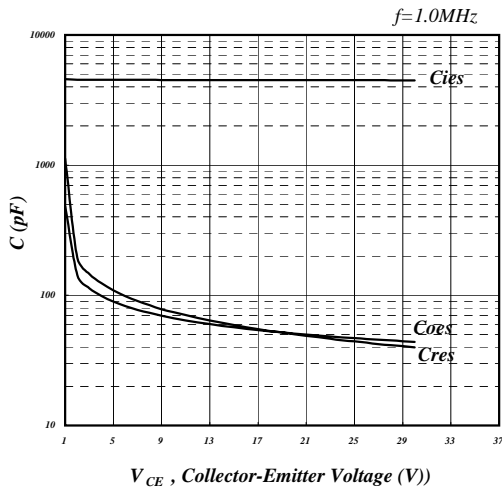

Fig 7. Typical Capacitance Characteristics

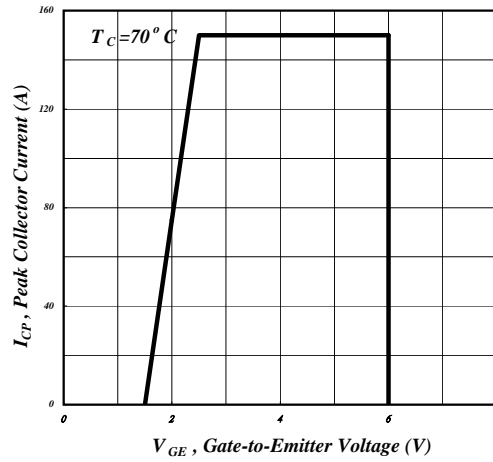

Fig 8. Maximum Pulse Collector Current

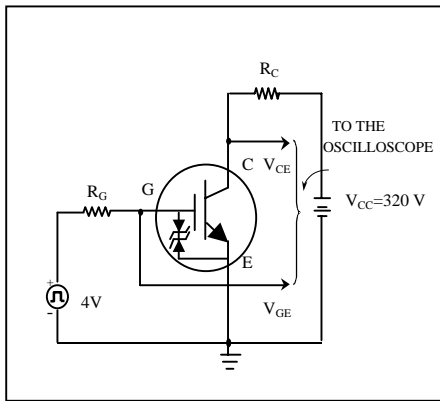

Fig 9. Switching Time Test Circuit

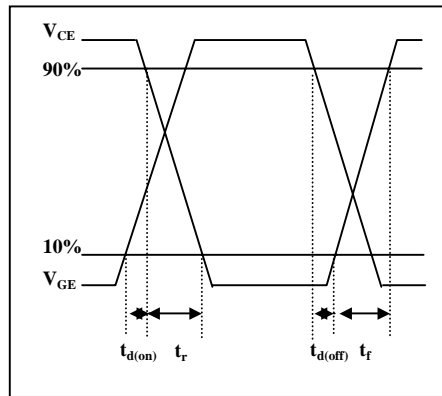

Fig 10. Switching Time Waveform

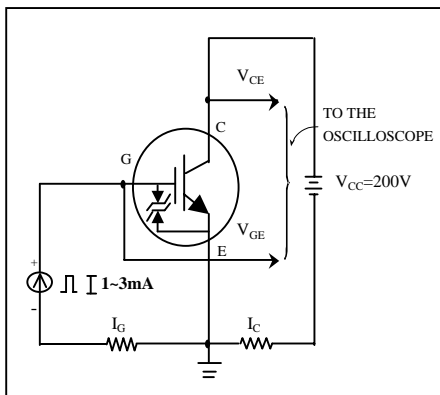

Fig 11. Gate Charge Test Circuit

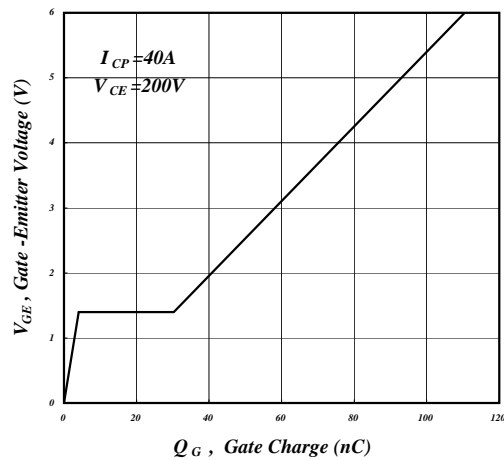

Fig 12. Gate Charge Waveform



AP28G45GEO-HF

dV/dt Design Notice

You should be design dV/dt value is below 400V/us, $R_G=30\Omega$ when IGBT turn off.

- Definition of dV/dt

The slope of VCE from 30V to 90V

$$\begin{aligned} dv/dt &= (90V-30V) / \delta t \\ &= 60V / \delta t \end{aligned}$$

- Waveform

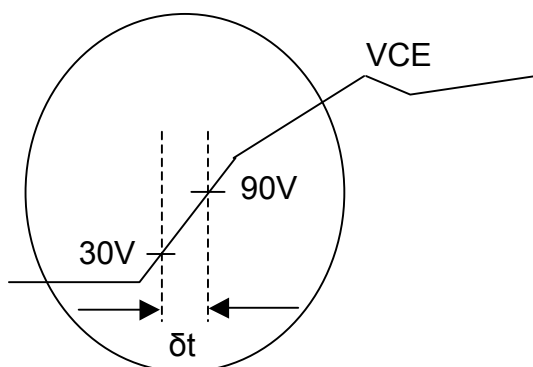
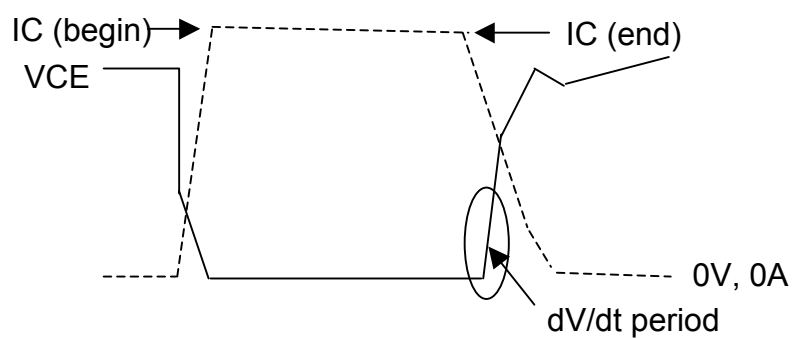

Caution on Usage

This product is sensitive to electrostatic discharge, please handle with caution.