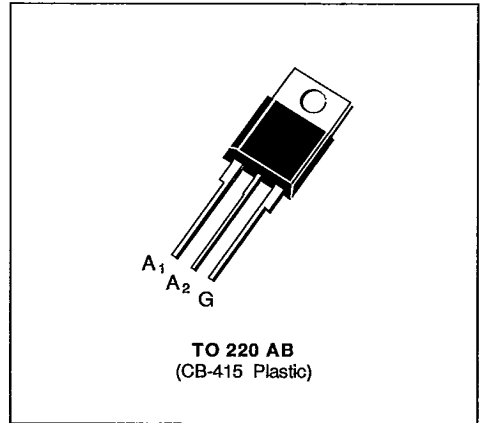

SNUBBERLESS TRIACS

- $I_{TRMS} = 10\text{ A}$ at $T_c = 100\text{ }^\circ\text{C}$.
- $V_{DRM} : 200\text{ V to } 800\text{ V}$.
- $I_{GT} = 75\text{ mA}$ (QI-II-III).
- GLASS PASSIVATED CHIP.
- HIGH SURGE CURRENT : $I_{TSM} = 100\text{ A}$.
- HIGH COMMUTATION CAPABILITY :
 $(di/dt)_c > 12\text{ A/ms}$ without snubber.

DESCRIPTION

New range suited for applications such as phase control and static switching on inductive or resistive load.

ABSOLUTE RATINGS (limiting values)

Symbol	Parameter		Value	Unit
I_{TRMS}	RMS on-state current (360 ° conduction angle)	$T_c = 100\text{ }^\circ\text{C}$	10	A
I_{TSM}	Non repetitive surge peak on-state current (T_j initial = 25 °C)	$t = 8.3\text{ ms}$	105	A
		$t = 10\text{ ms}$	100	
I^2t	I^2t value	$t = 10\text{ ms}$	50	A^2s
di/dt	Critical rate of rise of on-state current (1)	Repetitive $F = 50\text{ Hz}$	20	A/ μs
		Non Repetitive	100	
T_{stg} T_j	Storage and operating junction temperature range		- 40, + 150 - 40, + 125	$^\circ\text{C}$ $^\circ\text{C}$

Symbol	Parameter	BTB 10-					Unit
		200 AW	400 AW	600 AW	700 AW	800 AW	
V_{DRM}	Repetitive peak off-state voltage (2)	± 200	± 400	± 600	± 700	± 800	V

(1) Gate supply : $I_g = 750\text{ mA} - di_G/dt = 1\text{ A}/\mu\text{s}$.

(2) $T_j = 125\text{ }^\circ\text{C}$.

THERMAL RESISTANCES

Symbol	Parameter	Value	Unit
$R_{th(j-a)}$	Junction to ambient	60	°C/W
$R_{th(j-c)} DC$	Junction to case for DC	2.7	°C/W
$R_{th(j-c)} AC$	Junction to case for 360° conduction angle ($F = 50$ Hz)	2	°C/W

GATE CHARACTERISTICS (maximum values)

$P_{GM} = 40$ W ($t_r = 10$ μ s) $P_{G(AV)} = 1$ W $I_{GM} = 4$ A ($t = 10$ μ s) $V_{GM} = 16$ V ($t = 10$ μ s).

ELECTRICAL CHARACTERISTICS

Symbol	Test Conditions	Quadrants	Min.	Typ.	Max.	Unit
I_{GT}	$T_j = 25$ °C $V_D = 12$ V Pulse duration > 20 μ s $R_L = 33$ Ω	I-II-III	2		75	mA
V_{GT}	$T_j = 25$ °C $V_D = 12$ V Pulse duration > 20 μ s $R_L = 33$ Ω	I-II-III			1.5	V
V_{GD}	$T_j = 125$ °C $V_D = V_{DRM}$ Pulse duration > 20 μ s $R_L = 3.3$ k Ω	I-II-III	0.2			V
I_{H^*}	$T_j = 25$ °C $I_T = 100$ mA Gate open $R_L = 140$ Ω				75	mA
I_L	$T_j = 25$ °C $V_D = 12$ V Pulse duration > 20 μ s $I_G = 500$ mA	I-III		75		mA
		II		150		
V_{TM}^*	$T_j = 25$ °C $I_{TM} = 14$ A $t_p = 10$ ms				1.65	V
I_{DRM}^*	$T_j = 25$ °C $T_j = 125$ °C	V_{DRM} rated Gate open			0.01	mA
					2	
dv/dt^*	$T_j = 125$ °C Gate open Linear slope up to 0.67 V_{DRM}		750	1000		V/ μ s
$(di/dt)_c^*$	$T_j = 125$ °C V_{DRM} rated Without snubber		12	24		A/ms
t_{gt}	$T_j = 25$ °C $di_G/dt = 3.5$ A/ μ s $I_T = 14$ A $V_D = V_{DRM}$	$I_G = 500$ mA I-II-III		2		μ s

* For either polarity of electrode A_2 voltage with reference to electrode A_1 .

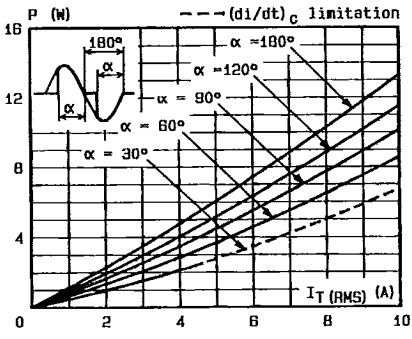

Fig.1 - Maximum mean power dissipation versus RMS on-state current ($f = 60$ Hz).

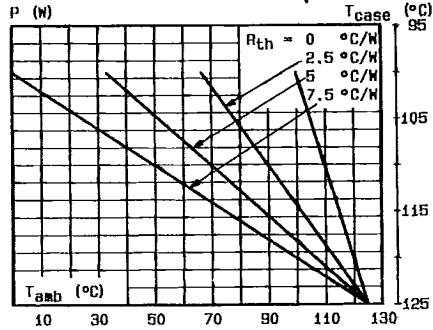

Fig.2 - Correlation between maximum mean power dissipation and maximum allowable temperatures (T_{amb} and T_{case}) for different thermal resistances heatsink + contact.

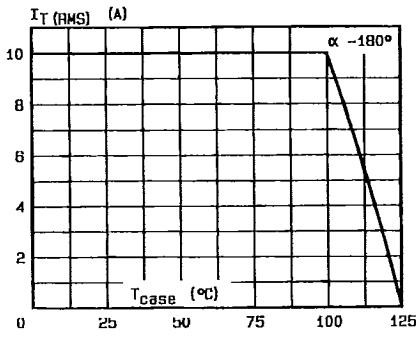

Fig.3 - RMS on-state current versus case temperature.

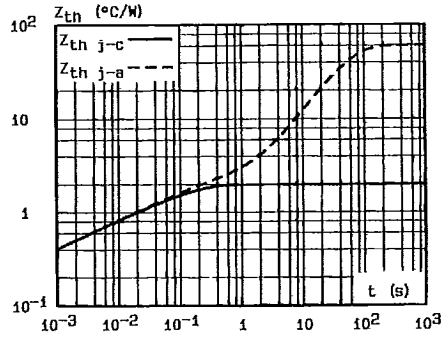

Fig.4 - Thermal transient impedance junction to case and junction to ambient versus pulse duration.

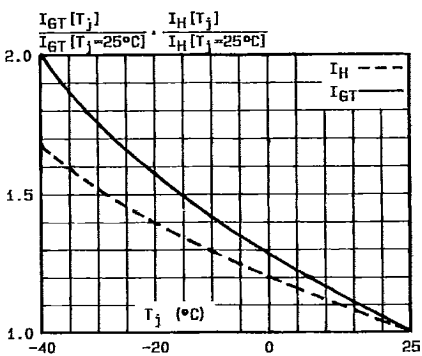

Fig.5 - Relative variation of gate trigger current and holding current versus junction temperature.

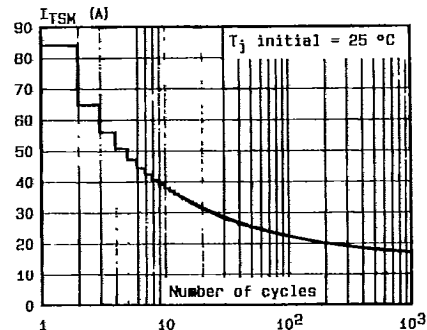

Fig.6 - Non repetitive surge peak on-state current versus number of cycles.

SGS-THOMSON

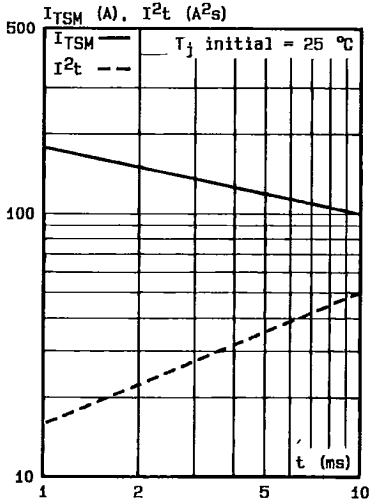

Fig.7 - Non repetitive surge peak on-state current for a sinusoidal pulse with width : $t \leq 10 \text{ ms}$, and corresponding value of I^2t .

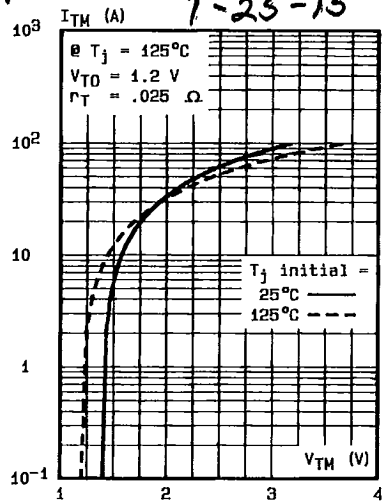
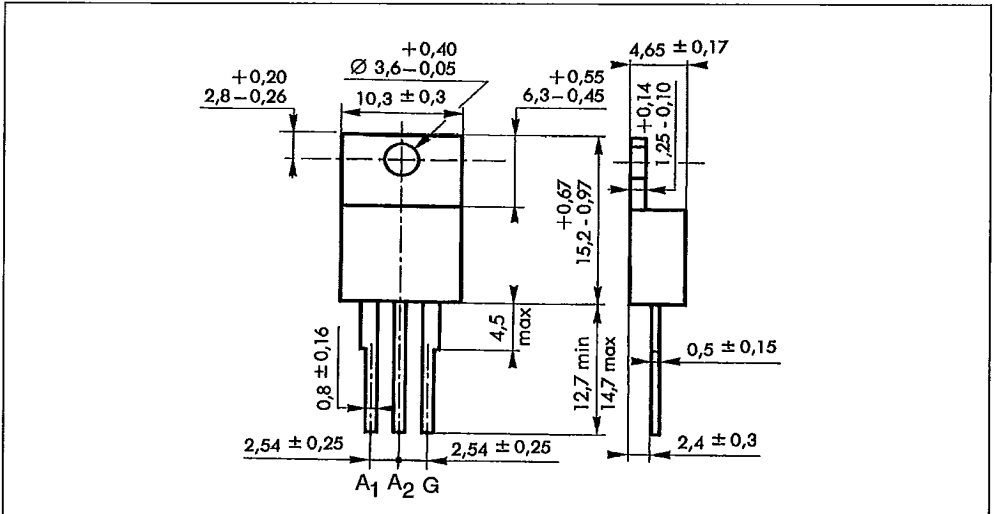

Fig.8 - On-state characteristics (maximum values).

PACKAGE MECHANICAL DATA

TO 220 AB (CB-415) Plastic



Cooling method : by conduction (method C)
 Marking : type number
 Weight : 2 g