



FEATURES

- ◆ Efficiency up to 85%
- ◆ Twin Independent Output
- ◆ Small Footprint
- ◆ SMD Package Styles
- ◆ No Heatsink Required
- ◆ 1KVDC Isolation
- ◆ High Power Density
- ◆ Temperature Range: -40°C ~ +85°C
- ◆ No External Component Required
- ◆ Internal SMD construction
- ◆ RoHS Compliance

MODEL SELECTION

D^① 05^② 05^③ 05^④ N^⑤ X^⑥ T^⑦-2W^⑧

- ① Product Series
- ② Input Voltage
- ③ The 1st Output Voltage
- ④ The 2nd Output Voltage
- ⑤ No Pin
- ⑥ Fixed Input
- ⑦ SMD Package
- ⑧ Rated Power

APPLICATIONS

The D_NXT-2W series are specially designed for applications where a group of polar power supplies are isolated from the input power supply in a distributed power supply system on a circuit board. These products apply to:

- 1) Where the voltage of the input power supply is fixed (voltage variation $\leq 10\%$);
- 2) Where isolation is necessary between input and output (isolation voltage $\leq 1000\text{VDC}$);
- 3) Where the regulation of the output voltage and the output ripple and noise are not demanding.

Such as: purely digital circuits, ordinary low frequency analog circuits and IGBT power device driven circuits, etc.



CE REACH
MICRODC reserves the copyright

SELECTION GUIDE

Model Number	Input Voltage(VDC)	Output Voltage (VDC)	Output Current (mA)		Input Current(mA)(typ.)		Reflected Ripple Current (mA,typ.)	Max. Capacitive Load(μF)	Efficiency (% ,typ.) @Max. Load
	Nominal (Range)		Max.	Min.	@Max. Load	@No Load			
D050505NXT-2W	5(4.5-5.5)	5/5	200/200	20/20	478	32	50	100	82
D050909NXT-2W	5(4.5-5.5)	9/9	112/112	12/12	482	48	42	100	83
D051212NXT-2W	5(4.5-5.5)	12/12	84/84	9/9	483	55	32	100	84
D051515NXT-2W	5(4.5-5.5)	15/15	67/67	7/7	470	29	27	100	85
D120505NXT-2W	12(10.8-13.2)	5/5	200/200	20/20	199	19	25	100	82
D120909NXT-2W	12(10.8-13.2)	9/9	112/112	12/12	200	20	27	100	83
D121212NXT-2W	12(10.8-13.2)	12/12	84/84	9/9	198	18	24	100	84
D121515NXT-2W	12(10.8-13.2)	15/15	67/67	7/7	196	18	25	100	85

Note: The D_NXT-1W series also are available in our company.

INPUT SPECIFICATIONS

Item	Test Conditions	Min.	Typ.	Max.	Units
Input Surge Voltage (1sec. max.)	5VDC Input Models	-0.7	--	9	VDC
Input Surge Voltage (1sec. max.)	12VDC Input Models	-0.7	--	18	VDC
Input Filter				C Filter	

ISOLATION SPECIFICATIONS

Item	Test Conditions	Min.	Typ.	Max.	Units
Output Power		0.2	--	2	W
Output Voltage Accuracy		See tolerance envelope graph			
Line Regulation	For V_{in} change of $\pm 1\%$	--	--	± 1.2	%
Load Regulation	10% to 100% load (5V output)	--	12.8	15	%
Load Regulation	10% to 100% load (9V output)	--	8.3	10	%
Load Regulation	10% to 100% load (12V output)	--	6.8	10	%
Load Regulation	10% to 100% load (15V output)	--	6.0	10	%
Temperature Drift	100% full load	--	--	± 0.03	%/°C
Ripple & Noise*	20MHz Bandwidth	--	75	150	mVp-p
Short Circuit Protection**		--	--	1	S

Note: *Test ripple and noise by "Parallel cable" method. See detailed operation instructions at Testing of Power Converter section, application notes.

**Supply voltage must be discontinued at the end of short circuit duration.

COMMON SPECIFICATIONS

Item	Test Conditions	Min.	Typ.	Max.	Units
Isolation Voltage(Vin/Vout)	Tested for 1 minute and leakage current less than 1 mA	1000	--	--	VDC
Isolation Voltage(Vo1/Vo2)		1000	--	--	
Isolation Resistance(Vin/Vout)	Test at 500VDC	1000	--	--	MΩ
Isolation Resistance(Vo1/Vo2)		1000	--	--	
Isolation Capacitance(Vin/Vout)	Input/Output, 100KHz/1V	--	60	--	pF
Isolation Capacitance(Vo1/Vo2)		--	60	--	
Switching Frequency	Full load, nominal input	--	100	--	KHz
MTBF	MIL-HDBK-217F@25°C	3500	--	--	K hours
Case Material		Epoxy Resin (UL94-V0)			
Weight		--	2.1	--	g

ENVIRONMENTAL SPECIFICATIONS

Item	Test Conditions	Min.	Typ.	Max.	Units
Storage Humidity		--	--	95	%
Operating Temperature	Power derating (above 85°C)	-40	--	85	°C
Storage Temperature		-55	--	125	°C
Temp. rise at full load		--	25	--	°C
Lead Temperature	1.5mm from case for 10 seconds	--	--	300	°C
Cooling		Free air convection			

EMC SPECIFICATIONS

EMI	CE	CISPR22/EN55022 CLASS A	External Circuit Refer to Figure1
EMS	ESD	IEC/EN61000-4-2 Contact	±8KV perf. Criteria B

EMC RECOMMENDED CIRCUIT

EMI Recommended External Circuit (CLASS A):

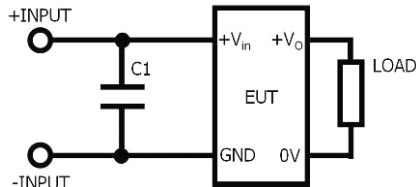

Recommended external circuit parameters:

- Vin: 5V
- C1: 4.7μF/50V 1210
- Vin: 12V
- C1: 1μF/50V 1210

(Figure 1)

PRODUCT TYPICAL CURVE

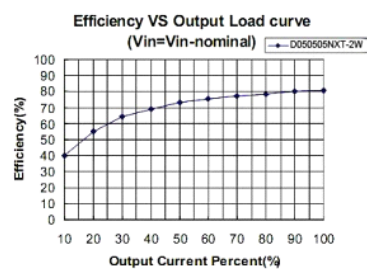
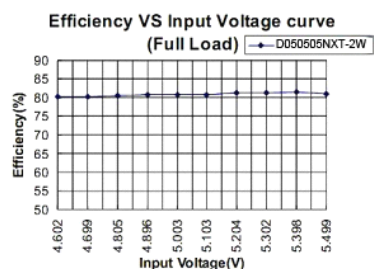
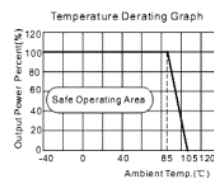
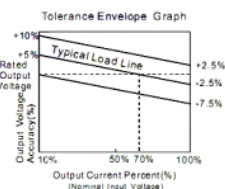

OUTLINE DIMENSIONS RECOMMENDED FOOTPRINT & PACKAGING

MECHANICAL DIMENSIONS

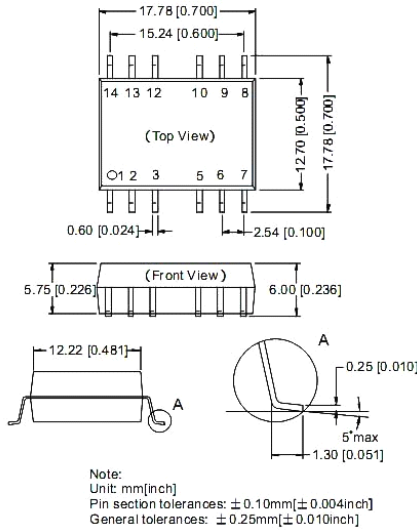

RECOMMENDED FOOTPRINT

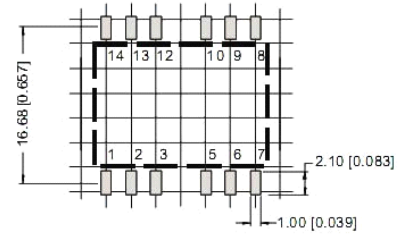

Note: grid 2.54*2.54mm.

FOOTPRINT DETAILS	
Pin	Function
1	GND
2	Vin
5	OV1
6	Vo1
9	Vo2
10	OV2
Others	NC

NC: No Connection

TUBE OUTLINE DIMENSIONS

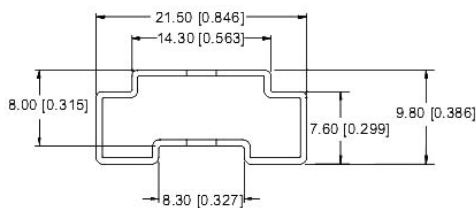

Note:
Unit: mm[inch]
General tolerances: $\pm 0.50\text{mm} [\pm 0.020\text{inch}]$
L=53.0mm[20.866inch] Devices per tube quantity: 28pcs
L=22.0mm[8.661inch] Devices per tube quantity: 10pcs
Short tube inner package dimensions: L*W*H= 255*170*80mm
Short tube outer package dimensions(with six inner package boxes):
L*W*H= 375*280*270mm
Long tube inner package dimensions: L*W*H= 580*200*100mm
Long tube outer package dimensions(with two inner package boxes):
L*W*H= 600*215*220mm
Long tube outer package dimensions(with three inner package boxes):
L*W*H= 600*215*325mm

REEL PACKING OUTLINE DIMENSIONS

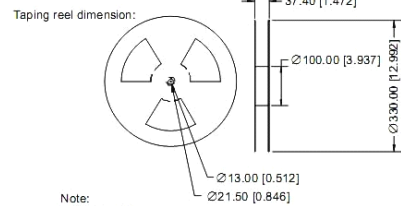
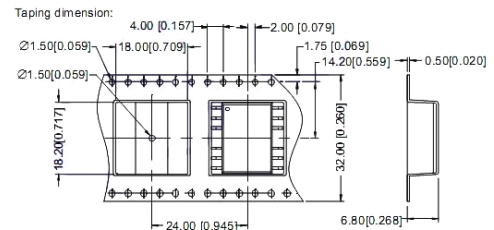

Note:
Unit: mm[inch]
General tolerances: $\pm 0.50\text{mm} [\pm 0.020\text{inch}]$
Per reel of packing quantity: 400pcs
Inner package carton dimensions: L*W*H= 365*350*105mm
Tube Quantity: 800pcs
Outer package carton dimensions: L*W*H= 390*360*245mm
Tube Quantity: 1600pcs

TEST CONFIGURATIONS

Input Reflected-Ripple Current Test Setup

Input reflected-ripple current is measured with an inductor Lin and Capacitor Cin to simulate source impedance.

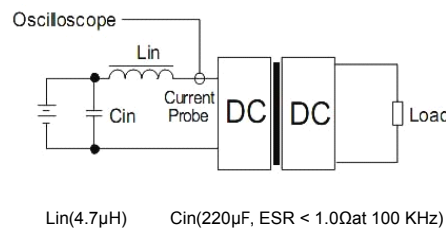

DESIGN CONSIDERATIONS

1) Requirement on output load

To ensure this module can operate efficiently and reliably, During operation, the minimum output load could not be less than 10% of the full load. If the actual output power is very small, please connect a resistor with proper resistance at the output end in parallel to increase the load, or use our company products with a lower rated output power (D-NXT-2W).

2) Overload Protection

Under normal operating conditions, the output circuit of these products has no protection against overload. The simplest method is to connect a self-recovery fuse in series at the input end or add a circuit breaker to the circuit.

Input Fuse Selection Guide

5VDC Input Models	1000mA slow-Blow Type	12VDC Input Models	500mA slow-Blow Type
-------------------	-----------------------	--------------------	----------------------

3) Recommended circuit

If you want to further decrease the input/output ripple, a capacitor filtering network may be connected to the input and output ends of the DC/DC converter, see (Figure 2).

It should also be noted that the capacitance of filter capacitor must be proper. If the capacitance is too big, a startup problem might arise. For every channel of output, provided the safe and reliable operation is ensured, the recommended capacitance of its filter capacitor sees (Table 1).

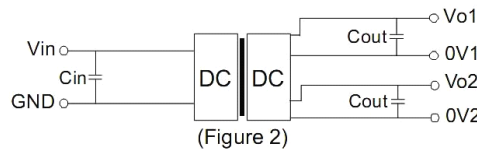

(Figure 2)

EXTERNAL CAPACITOR TABLE (TABLE 1)

Vin (VDC)	Cin (μF)	Vout (VDC)	Cout (μF)
5	4.7	5	4.7
12	2.2	9	2.2
-	-	12	1
-	-	15	0.47

It's not recommended to connect any external capacitor in the application field with less than 0.5 watt output.

4) Output Voltage Regulation and Over-voltage Protection Circuit

The simplest device for output voltage regulation, over-voltage and over-current protection is a linear regulator and an capacitor filtering network with overheat protection that is connected to the input or output end in series (Figure 3), the recommended capacitance of its filter capacitor sees (Table 1), linear regulator based on the actual voltage and current to required.

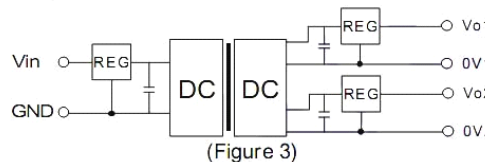

(Figure 3)

5) Cannot use in parallel and hot swap

Note:

1. Operation under minimum load will not damage the converter; However, they may not meet all specification listed.
2. Max. Capacitive Load tested at nominal input voltage, full load and constant resistive load.
3. All specifications measured at Ta=25°C, humidity<75%, nominal input voltage and rated output load unless otherwise specified.
4. In this datasheet, all the test methods of indications are based on our corporate standards.
5. All characteristics are for listed model only, non-standard models may perform differently, please contact our technical person for more detail.
6. Contact us for your specific requirement.
7. Specifications subject to change without prior notice.

RoHS COMPLIANT INFORMATION

This series is compatible with RoHS soldering systems with a peak wave solder temperature of 300° C for 10 seconds. The pin termination finish on the SIP package type is Tin Plate, Hot Dipped over Matte Tin with Nickel Preplate. The DIP types are Matte Tin over Nickel Preplate. Both types in this series are backward compatible with Sn/Pb soldering systems.

REACH COMPLIANT INFORMATION

This series has proven that this product does not contain harmful chemicals, it also has harmful chemical substances through the registration, inspection and approval.