

VI TELEFILTER**Filter Specification****TFS 70H25A 1/5****Measurement condition**

Ambient temperature: 25 °C
 Input power level: 10 dBm
 Terminating impedances at f_C^* : for input: 350 Ω | -13,7 pF
 for output: 450 Ω | -12,1 pF

Remark:

Reference level for the relative attenuation a_{rel} of the TFS 70H25A is the insertion loss. The insertion loss a_e is defined as the insertion loss at the nominal frequency f_N . The centre frequency f_C is the arithmetic mean value of the upper and lower frequencies at the 3 dB filter attenuation level relative to the insertion loss a_e . The temperature coefficient of frequency T_C is valid for both the reference frequency f_C and the frequency response of the filter on the operating temperature.

Data		typ. value		tolerance/limit		
Insertion loss (Reference level)	a_e	21,8	dB	max.	25,0	dB
Nominal frequency	f_N	-			70,0	MHz
Centre frequency	f_C	70,0	MHz	70 MHz	\pm 80	kHz
Passband	PB			$f_N \pm$	0,65	MHz
Passband variation	p-p	0,45	dB		0,60	dB
1 dB bandwidth	BW	1,55	MHz	min.	1,30	MHz
3 dB bandwidth	BW	1,72	MHz	min.	1,50	MHz
40 dB bandwidth	BW	2,55	MHz	max.	2,80	MHz
Relative attenuation	a_{rel}					
f_N ...	$f_N \pm$ 0,65 MHz	-		max.	1	dB
$f_N \pm$ 0,65 MHz...	$f_N \pm$ 0,75 MHz	-		max.	3	dB
$f_N \pm$ 1,40 MHz	$f_N \pm$ 2,50 MHz	45	dB	min.	40	dB
$f_N \pm$ 2,50 MHz	$f_N \pm$ 30 MHz	52	dB	min.	50	dB
Phase linearity in PB		3	°	max.	6	°
Group delay variation in PB		160	ns	max.	200	ns
Temperature coefficient of frequency T_C (*)		- 0.036 ppm/K ²				
Operating temperature		25 °C				
Storage temperature range		- 25..... + 85 °C				

*) $\Delta f_C(\text{Hz}) = T_C(\text{ppm/K}^2) \times (T - T_A)^2 \times f_{CAT}(\text{MHz})$

Generated:

Checked / approved:

VI TELEFILTER
 Potsdamer Straße 18
 D 14 513 TELTOW / Germany
 Tel: (+49) 3328 4784-0 / Fax: (+49) 3328 4784-30
 E-Mail: tft@telefilter.com

Vectron International, Inc.
 267 Lowell Road
 Hudson, NH 03051 / USA
 Tel: (603) 598-0070 Fax: (603) 598-0075
 E-Mail: vti@vtinh.com

VI TELEFILTER reserves the right to make changes to the product(s) and/or information contained herein without notice. No liability is assumed as a result of their use or application. No rights under any patent accompany the sale of any such product(s) or information.

VI TELEFILTER

Filter Specification

TFS 70H25A 2/5

Construction, pin configuration and 50 Ω - matching network

(All dimensions in mm)

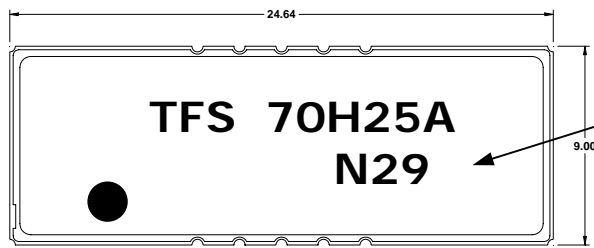

Datecode:	Year+week
L	1999
M	2000
N	2001
....	

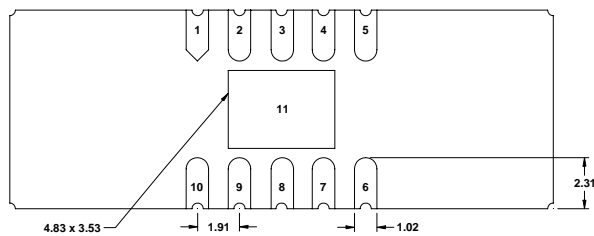
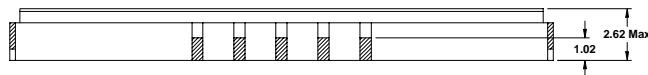

Pin Configuration

Input:	10
Input Return:	1
Output:	5
Output Return:	6
Ground:	2,3,4,7,8,9,11

50 Ohm test circuit

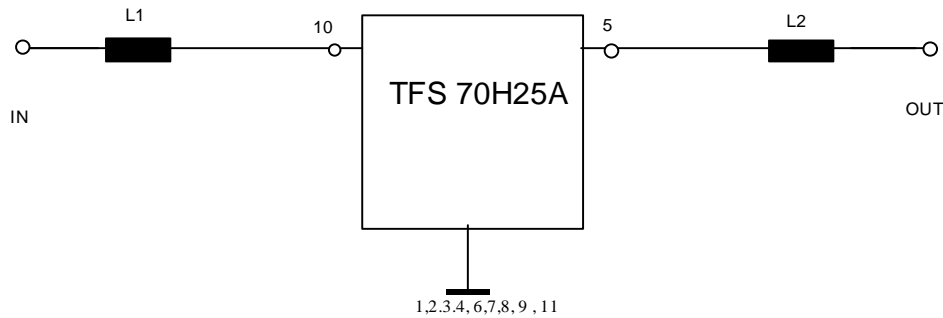

VI TELEFILTER
 Potsdamer Straße 18
 D 14 513 TELTOW / Germany
 Tel: (+49) 3328 4784-0 / Fax: (+49) 3328 4784-30
 E-Mail: tft@telefilter.com

Vectron International, Inc.
 267 Lowell Road
 Hudson, NH 03051 / USA
 Tel: (603) 598-0070 Fax: (603) 598-0075
 E-Mail: vti@vtinh.com

VI TELEFILTER reserves the right to make changes to the product(s) and/or information contained herein without notice. No liability is assumed as a result of their use or application. No rights under any patent accompany the sale of any such product(s) or information.

VI TELEFILTER**Filter Specification****TFS 70H25A 3/5****Stability characteristics**

After the following tests the filter shall meet the whole specification:

1. Shock: 500g, 18 ms, half sine wave, 3 shocks each plane;
DIN IEC 68 T2 - 27
2. Vibration: 10 Hz to 500 Hz, 0,35 mm or 5g respectively, 1 octave per min, 10 cycles per plan, 3 plans;
DIN IEC 68 T2 - 6
3. Damp heat: 25 °C to 55°C / 95% r.H. / 10 cycles
(cycle) DIN IEC 68 - 2 – 30 Db
4. Resistance to solder heat (reflow): max. 2 times reflow process;
for temperature conditions refer to the attached "Air reflow temperature conditions" on page 4;

Packing

tape & reel: IEC 286 - 3, with exception of value for N and minimum bending radius;
tape type II, embossed carrier tape with top cover tape on the upper side;

max. pieces of filters per reel: 1000
reel of empty components at start: min 300 mm
reel of empty components at start including leader: min 500 mm
trailer: min 300 mm

Tape (all dimensions in mm)

W	:	44	± 0,3
Po	:	4	± 0,1
Do	:	1,5	+ 0,1
E	:	1,75	± 0,1
F	:	20,25	± 0,05
G (min)	:	0,75	
P2	:	2	± 0,05
P1	:	16	± 0,1
D1(min)	:	2,0	
Ao	:	9,3	± 0,1
Bo	:	24,9	± 0,1
CT	:	38	± 0,2

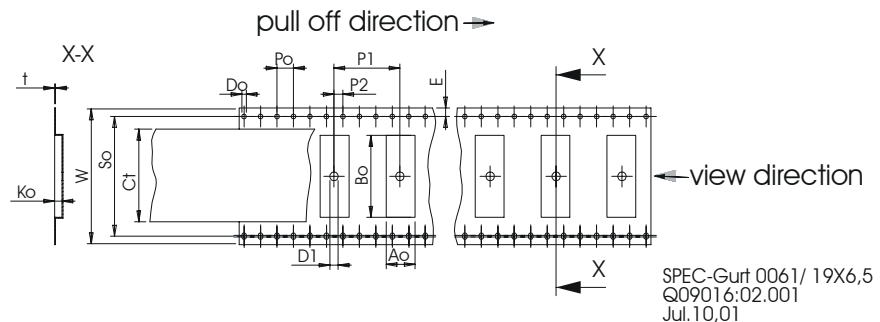
**Reel (all dimensions in mm):**

A	:	330
W1	:	46
W2 (max)	:	50
N (min)	:	100
C	:	13 ± 0,2

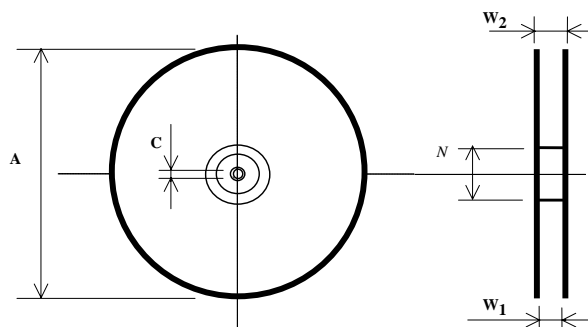

The minimum bending radius is 45 mm. The mounting surface of the filters faces the bottom side of the embossed carrier tape. The marking of the filters is able to read if the view is directed on the upper side of the carrier tape in the above shown direction.

VI TELEFILTER
Potsdamer Straße 18
D 14 513 TELTOW / Germany
Tel: (+49) 3328 4784-0 / Fax: (+49) 3328 4784-30
E-Mail: tft@telefilter.com

Vectron International, Inc.
267 Lowell Road
Hudson, NH 03051 / USA
Tel: (603) 598-0070 Fax: (603) 598-0075
E-Mail: vti@vtinh.com

VI TELEFILTER reserves the right to make changes to the product(s) and/or information contained herein without notice. No liability is assumed as a result of their use or application. No rights under any patent accompany the sale of any such product(s) or information.

VI TELEFILTER**Filter Specification****TFS 70H25A 4/5****Air reflow temperature conditions**

1st and 2nd air reflow profile

Name:	pre-heating periods	main-heating periods	peak temperature
Temperature:	150 °C - 170 °C	over 200 °C	255 °C ± 5 °C
Time:	60 sec. - 90 sec.	20 sec. - 25 sec.	

Chip-mount air reflow profile

Table for temperature vs. time during the air reflow process

Tolerance of temperatures: ± 5 °C

time / sec.	temperature / °C	time / sec.	temperature / °C
0	23	140	160
10	34	150	161
20	46	160	164
30	60	170	170
40	80	180	180
50	103	190	205
60	121	195	230
70	134	200	255
80	143	205	230
90	150	210	205
100	154	215	180
110	156	220	165
120	158	230	140
130	159	240	120

VI TELEFILTER
 Potsdamer Straße 18
 D 14 513 TELTOW / Germany
 Tel: (+49) 3328 4784-0 / Fax: (+49) 3328 4784-30
 E-Mail: tft@telefilter.com

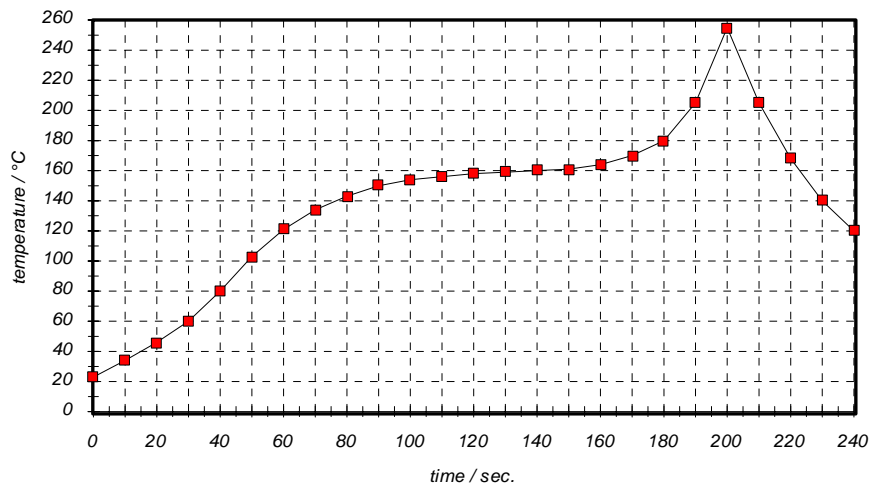
Vectron International, Inc.
 267 Lowell Road
 Hudson, NH 03051 / USA
 Tel: (603) 598-0070 Fax: (603) 598-0075
 E-Mail: vti@vtinh.com

VI TELEFILTER reserves the right to make changes to the product(s) and/or information contained herein without notice. No liability is assumed as a result of their use or application. No rights under any patent accompany the sale of any such product(s) or information.

VI TELEFILTER**Filter Specification****TFS 70H25A 5/5****History**

version	reason of changes	name	date
1.0	generate specification	Pfeifer	22.03.2001
1.1	correct relative attenuation	Dr. Sabah	24.04.2001
1.2	terminated impedances added	Pfeiffer	18.07.2001

VI TELEFILTER
Potsdamer Straße 18
D 14 513 TELTOW / Germany
Tel: (+49) 3328 4784-0 / Fax: (+49) 3328 4784-30
E-Mail: tft@telefilter.com

Vectron International, Inc.
267 Lowell Road
Hudson, NH 03051 / USA
Tel: (603) 598-0070 Fax: (603) 598-0075
E-Mail: vti@vtinh.com

VI TELEFILTER reserves the right to make changes to the product(s) and/or information contained herein without notice. No liability is assumed as a result of their use or application. No rights under any patent accompany the sale of any such product(s) or information.