

**NEW!**

High Power PoE Signal Path Magnetics



- Meets the current requirements of Gigabit PoE Plus.
- Open circuit inductance is $\geq 350 \mu\text{H}$ with a 22.5 mA dc offset
- Handle up to 800 mA.

Core material Ferrite

Terminations RoHS Tin-silver-copper over tin over nickel over phos bronze. Other terminations available at additional cost.

Weight HPF2187L: 240 mg; HPX2126L: 3.9 g

Ambient temperature -40°C to $+85^\circ\text{C}$

Storage temperature Component: -40°C to $+85^\circ\text{C}$.

Packaging: -40°C to $+80^\circ\text{C}$

Resistance to soldering heat Max three 40 second reflows at $+260^\circ\text{C}$, parts cooled to room temperature between cycles

Moisture Sensitivity Level (MSL) 1 (unlimited floor life at $<30^\circ\text{C}$ / 85% relative humidity)

Failures in Time (FIT) / Mean Time Between Failures (MTBF)

38 per billion hours / 26,315,789 hours, calculated per Telcordia SR-332

Packaging

HPF2187L: 500/7" reel; 2000/13" reel; Plastic tape: 16 mm wide, 0.35 mm thick, 8 mm pocket spacing, 4.4 mm pocket depth

HPX2126L: 300/13" reel; Plastic tape: 32 mm wide, 0.5 mm thick, 20 mm pocket spacing, 11 mm pocket depth

PCB washing Only pure water or alcohol recommended

Isolation Transformer

Part number ¹	Inductance ² (μH)	DCR max ³ (Ohms)	Isolation ⁴ (Vrms)
HPX2126L_	850	0.24	1500

1. When ordering, please specify **packaging** code:

↓
HPX2126LD

Packaging: **D** = 13" machine-ready reel. EIA-481 embossed plastic tape (300 parts per full reel).

B = Less than full reel. In tape, but not machine ready. To have a leader and trailer added (\$25 charge), use code letter D instead.

2. Inductance measured at 100 kHz, 0.1 Vrms, 0 Adc.

3. DCR is for each winding.

4. Isolation is measured from primary to secondary of each transformer.

5. Electrical specifications at 25°C .

Refer to Doc 362 "Soldering Surface Mount Components" before soldering.

Common Mode Choke

Part number ¹	Inductance ² (μH)	DCR max ³ (Ohms)
HPF2187L_	10.0	0.15

1. When ordering, please specify **packaging** code:

↓
HPF2187LC

Packaging: **C** = 7" machine-ready reel. EIA-481 embossed plastic tape (500 parts per full reel).

B = Less than full reel. In tape, but not machine ready. To have a leader and trailer added (\$25 charge), use code letter C instead.

D = 13" machine-ready reel. EIA-481 embossed plastic tape. Factory order only, not stocked (2000 parts per full reel).

2. Inductance measured at 100 kHz, 0.1 Vrms, 0 Adc.

3. DCR is for each winding.

4. Electrical specifications at 25°C .

Refer to Doc 362 "Soldering Surface Mount Components" before soldering.

Coilcraft®

Specifications subject to change without notice.
Please check our website for latest information.

Document 489-1 Revised 01/05/09

1102 Silver Lake Road Cary, Illinois 60013 Phone 847/639-6400 Fax 847/639-1469

E-mail info@coilcraft.com Web <http://www.coilcraft.com>



NEW!

High Power PoE Signal Path Magnetics

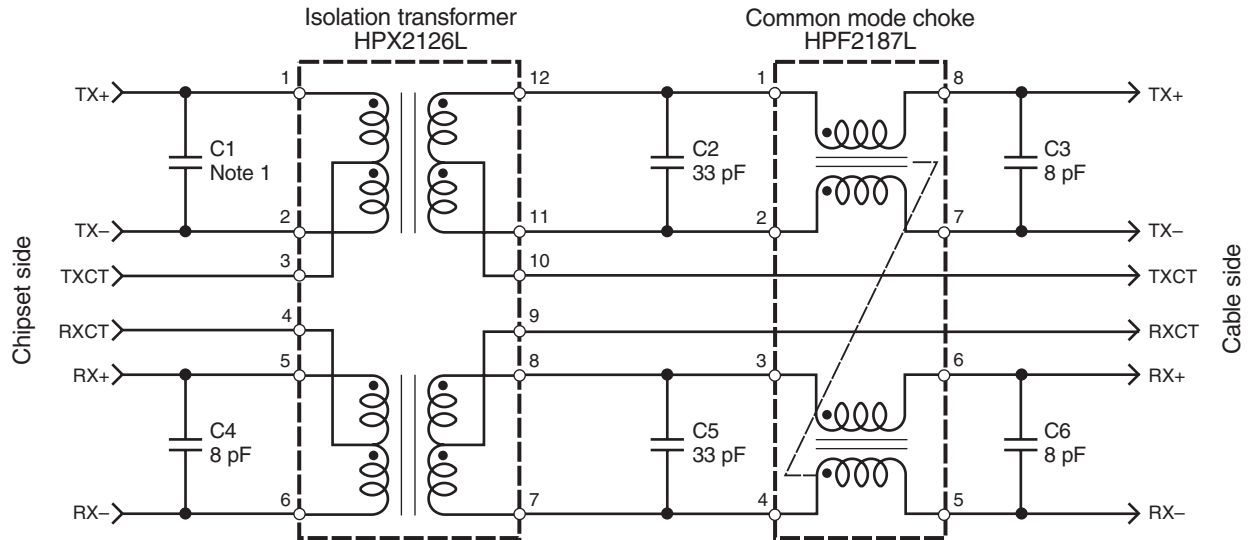

Note 1. C1 = 8 pF minus the output capacitance of the chipset

Isolation Transformer HPX2126L

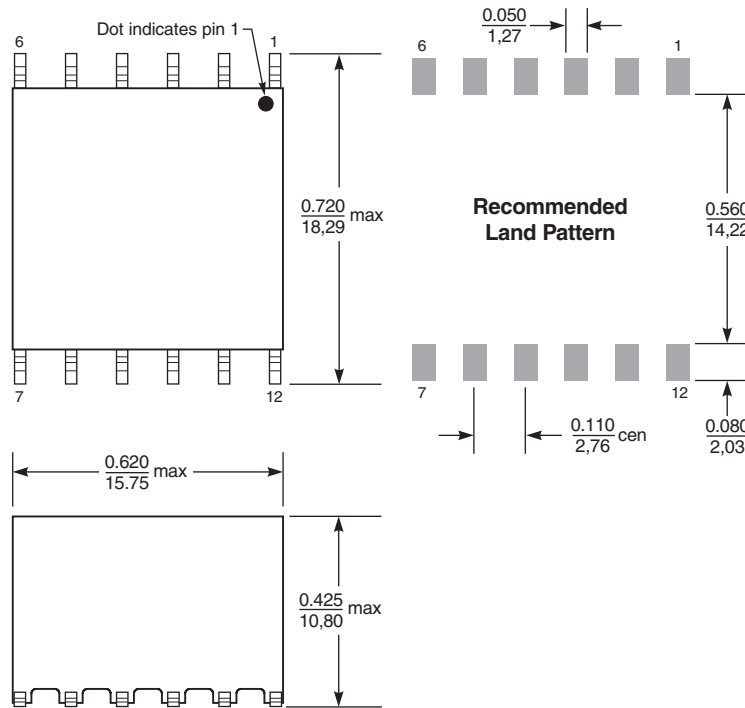

Dimensions are in $\frac{\text{inches}}{\text{mm}}$

Common Mode Choke HPF2187L

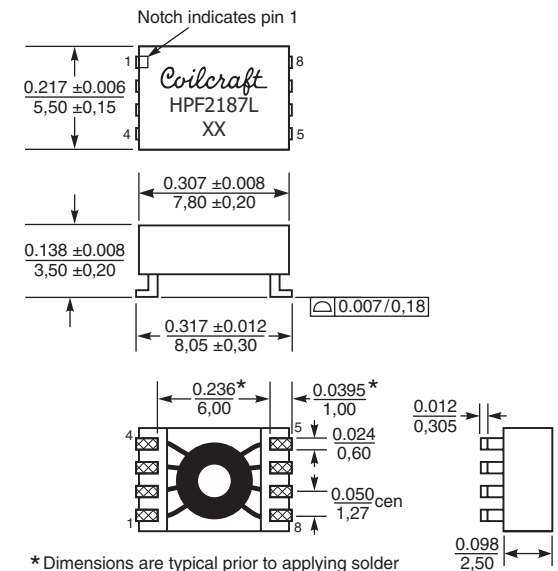

* Dimensions are typical prior to applying solder

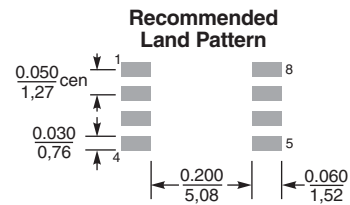

Dimensions are in $\frac{\text{inches}}{\text{mm}}$



Specifications subject to change without notice. Please check our website for latest information.

Document 489-2 Revised 01/05/09

1102 Silver Lake Road Cary, Illinois 60013 Phone 847/639-6400 Fax 847/639-1469

E-mail info@coilcraft.com Web <http://www.coilcraft.com>

**NEW!**

High Power PoE Signal Path Magnetics

Description

Coilcraft's signal path magnetics meet the current requirements of Gigabit Ethernet PoE Plus. The open circuit inductance is $\geq 350 \mu\text{H}$ with a 22.5 mA dc offset applied from 0°C to 70°C. It can handle 800 mA of current.

The system comprises an isolation transformer, a common mode choke and six capacitors. The capacitor across the primary of the isolation transformer on the TX side tunes the circuit by matching the output capacitance of the chipset allowing these components to be used with virtually all chipsets.

The two isolation transformers are placed in a single package (HPX2126L) and both common mode chokes in an even smaller package (HPF2187L). Both packages fit easily behind a standard Ethernet jack.

Testing

A matching network is used to perform the testing for return loss, insertion loss, crosstalk, common mode to common mode rejection and differential to common mode rejection. The network matches the 50 Ohm single ended connection of network analyzers to 100 Ohm differential balanced lines. A 1:1 balun is used with a resistive network to transform the impedance. The net-

work is then calibrated out of the measurement by using open, short, load calibration techniques. The circuit is then placed behind the matching network for each of the tests. All tests are performed on an Agilent/HP 8753ES network analyzer.

For return loss, the chip side of the component is loaded with 100 Ohms and the cable side of the system is tested using the matching network.

For insertion loss, the fixture used for the return loss is altered to replace the 100 Ohm load with a matching network for the output port of the network analyzer.

For common mode to common mode rejection, TX+ and TX- (or RX+ & RX-, depending on the side of the system) is tied together and an S21 measurement is taken from chip side to cable side.

For differential to common mode rejection, the chip side of the system is excited by the network analyzer through the matching network. The measurement is taken by looking at the balance between two 50 Ohm loads across the cable side of the system.

For crosstalk, the chip side TX is excited by the network analyzer through the matching network. The center-tap on the chip side of each isolation transformer is grounded, and the chip side RX is measured. The cable side of both RX and TX is externally loaded 100 Ohms.

Return Loss

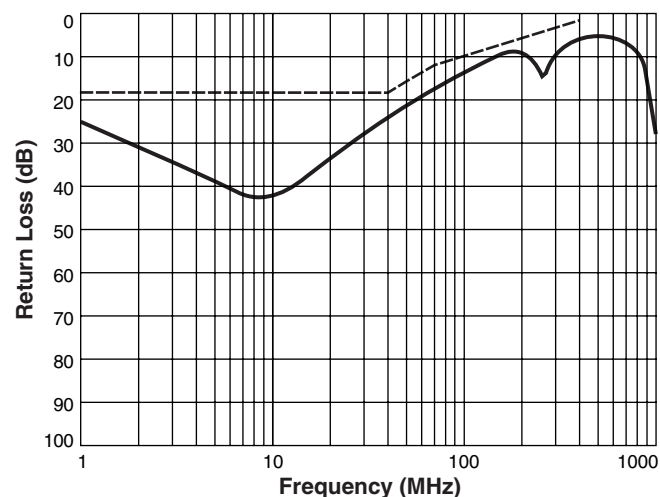

802.3af specification:
 18 dB min from 1 MHz to 40 MHz
 16 dB min at 50 MHz
 12 dB min at 80 MHz
 10 dB min at 100 MHz

Insertion Loss

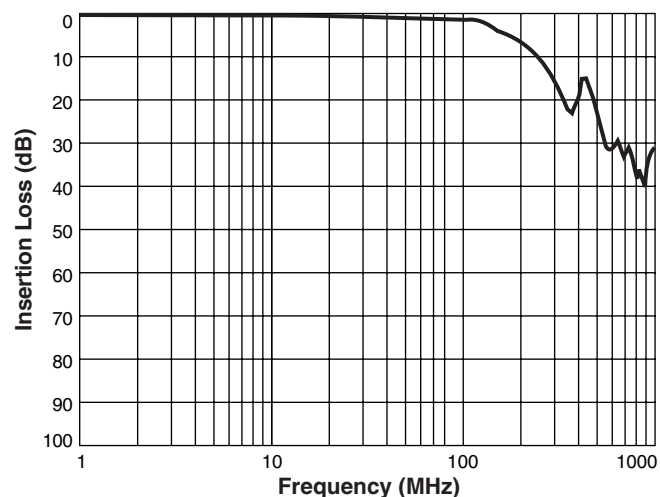

802.3af specification:
 1.0 min dB from 0.1 MHz to 100 MHz
 1.2 min dB at 125 MHz

Coilcraft®

Specifications subject to change without notice.
 Please check our website for latest information.

Document 489-3 Revised 01/05/09

1102 Silver Lake Road Cary, Illinois 60013 Phone 847/639-6400 Fax 847/639-1469

E-mail info@coilcraft.com Web <http://www.coilcraft.com>



NEW!

High Power PoE Signal Path Magnetics

Common Mode Rejection

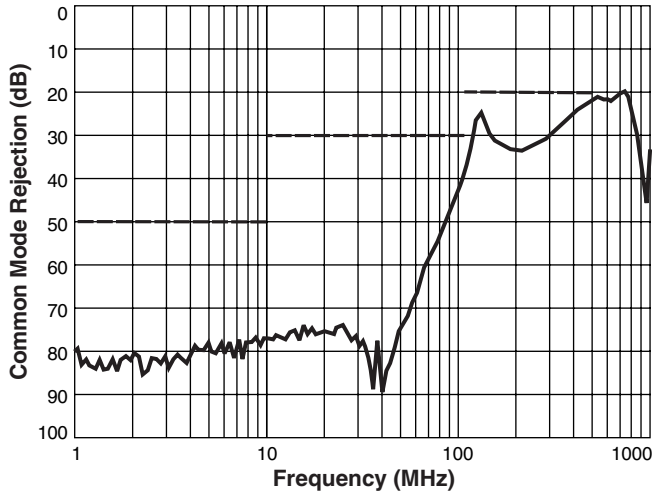

802.3af specification:
 50 dB min from 1 MHz to 10 MHz
 30 dB min from 10 MHz to 125 MHz
 20 dB min from 125 MHz to 500 MHz

Differential to Common Mode Rejection

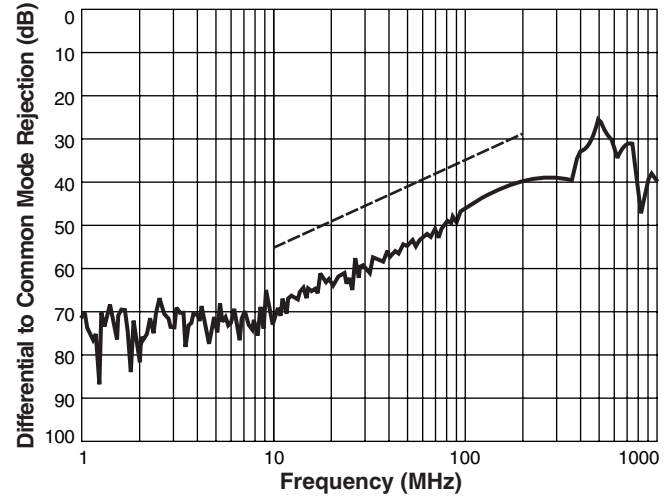

802.3af specification:
 45 dB min at 30 MHz
 40 dB min at 60 MHz
 35 dB min at 100 MHz

Crosstalk

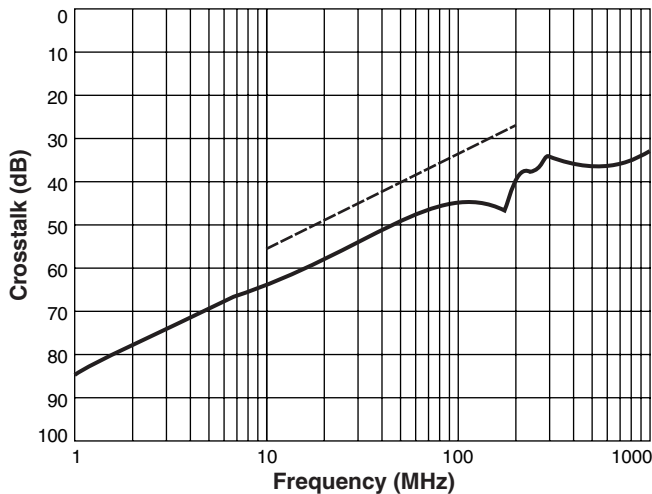

802.3af specification:
 45 dB min at 30 MHz
 40 dB min at 60 MHz
 33 dB min at 100 MHz

L vs Offset Current – HPX2126L

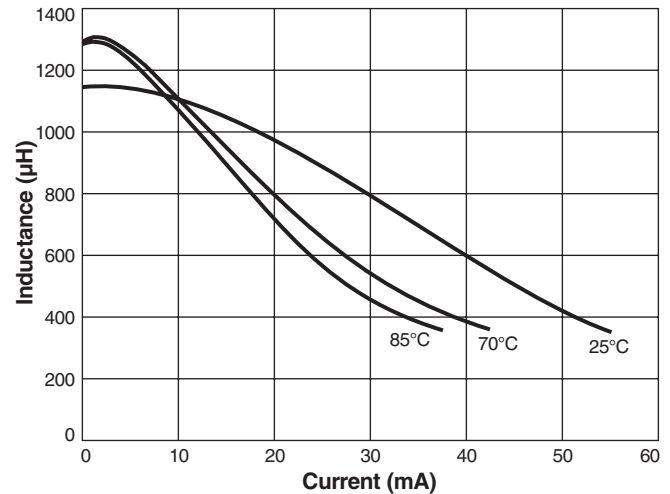

Specifications subject to change without notice.
 Please check our website for latest information.

Document 489-4 Revised 01/05/09

1102 Silver Lake Road Cary, Illinois 60013 Phone 847/639-6400 Fax 847/639-1469

E-mail info@coilcraft.com Web <http://www.coilcraft.com>