

IRF7474

HEXFET® Power MOSFET

Applications

- Telecom and Data-Com 24 and 48V input DC-DC converters
- Motor Control
- Uninterruptible Power Supply

Benefits

- Low On-Resistance
- High Speed Switching
- Low Gate Drive Current Due to Improved Gate Charge Characteristic
- Improved Avalanche Ruggedness and Dynamic dv/dt
- Fully Characterized Avalanche Voltage and Current

V_{DSS}	$R_{DS(on) \text{ max}}$	I_D
100V	63mΩ @ $V_{GS} = 10V$	4.5A

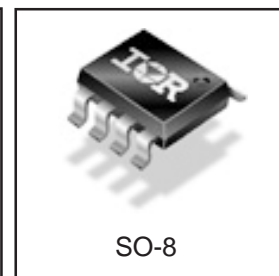
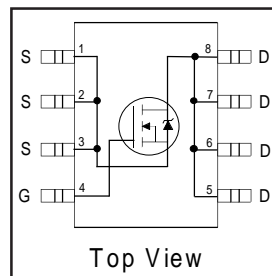

Absolute Maximum Ratings

	Parameter	Max.	Units
$I_D @ T_A = 25^\circ\text{C}$	Continuous Drain Current, $V_{GS} @ 10V$	4.5	A
$I_D @ T_A = 70^\circ\text{C}$	Continuous Drain Current, $V_{GS} @ 10V$	3.6	
I_{DM}	Pulsed Drain Current ①	36	
$P_D @ T_A = 25^\circ\text{C}$	Power Dissipation④	2.5	W
	Linear Derating Factor	0.02	W/°C
V_{GS}	Gate-to-Source Voltage	± 20	V
dv/dt	Peak Diode Recovery dv/dt ⑥	5.5	V/ns
T_J	Operating Junction and Storage Temperature Range	-55 to + 150	°C
T_{STG}			
	Soldering Temperature, for 10 seconds	300 (1.6mm from case)	

Thermal Resistance

Symbol	Parameter	Typ.	Max.	Units
$R_{\theta JL}$	Junction-to-Drain Lead	—	20	°C/W
$R_{\theta JA}$	Junction-to-Ambient ④	—	50	

Notes ① through ⑥ are on page 8
www.irf.com

IRF7474

International
IR Rectifier

Static @ T_J = 25°C (unless otherwise specified)

	Parameter	Min.	Typ.	Max.	Units	Conditions
V _{(BR)DSS}	Drain-to-Source Breakdown Voltage	100	—	—	V	V _{GS} = 0V, I _D = 250μA
ΔV _{(BR)DSS/ΔT_J}	Breakdown Voltage Temp. Coefficient	—	0.11	—	V/°C	Reference to 25°C, I _D = 1mA ③
R _{DS(on)}	Static Drain-to-Source On-Resistance	—	50	63	mΩ	V _{GS} = 10V, I _D = 2.7A ③
V _{GS(th)}	Gate Threshold Voltage	3.5	—	5.5	V	V _{DS} = V _{GS} , I _D = 250μA
I _{DSS}	Drain-to-Source Leakage Current	—	—	1.0	μA	V _{DS} = 95V, V _{GS} = 0V
		—	—	250		V _{DS} = 80V, V _{GS} = 0V, T _J = 150°C
I _{GSS}	Gate-to-Source Forward Leakage	—	—	100	nA	V _{GS} = 20V
	Gate-to-Source Reverse Leakage	—	—	-100		V _{GS} = -20V

Dynamic @ T_J = 25°C (unless otherwise specified)

	Parameter	Min.	Typ.	Max.	Units	Conditions
g _{fs}	Forward Transconductance	6.5	—	—	S	V _{DS} = 50V, I _D = 2.7A
Q _g	Total Gate Charge	—	27	41	nC	I _D = 2.7A
Q _{gs}	Gate-to-Source Charge	—	10	—		V _{DS} = 50V
Q _{gd}	Gate-to-Drain ("Miller") Charge	—	9.0	—		V _{GS} = 10V,
t _{d(on)}	Turn-On Delay Time	—	14	—	ns	V _{DD} = 50V
t _r	Rise Time	—	7.9	—		I _D = 2.7A
t _{d(off)}	Turn-Off Delay Time	—	16	—		R _G = 6.0Ω
t _f	Fall Time	—	5.9	—		V _{GS} = 10V ③
C _{iss}	Input Capacitance	—	1400	—	pF	V _{GS} = 0V
C _{oss}	Output Capacitance	—	100	—		V _{DS} = 25V
C _{riss}	Reverse Transfer Capacitance	—	56	—		f = 1.0MHz
C _{oss}	Output Capacitance	—	380	—		V _{GS} = 0V, V _{DS} = 1.0V, f = 1.0MHz
C _{oss}	Output Capacitance	—	68	—		V _{GS} = 0V, V _{DS} = 80V, f = 1.0MHz
C _{oss eff.}	Effective Output Capacitance	—	110	—		V _{GS} = 0V, V _{DS} = 0V to 80V ⑤

Avalanche Characteristics

	Parameter	Typ.	Max.	Units
E _{AS}	Single Pulse Avalanche Energy②	—	51	mJ
I _{AR}	Avalanche Current①	—	2.7	A

Diode Characteristics

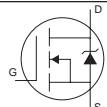
	Parameter	Min.	Typ.	Max.	Units	Conditions
I _S	Continuous Source Current (Body Diode)	—	—	2.3	A	MOSFET symbol showing the integral reverse p-n junction diode. 
I _{SM}	Pulsed Source Current (Body Diode) ①	—	—	36		
V _{SD}	Diode Forward Voltage	—	—	1.3	V	T _J = 25°C, I _S = 2.7A, V _{GS} = 0V ③
t _{rr}	Reverse Recovery Time	—	45	—	ns	T _J = 25°C, I _F = 2.7A
Q _{rr}	Reverse Recovery Charge	—	100	—	nC	di/dt = 100A/μs ③

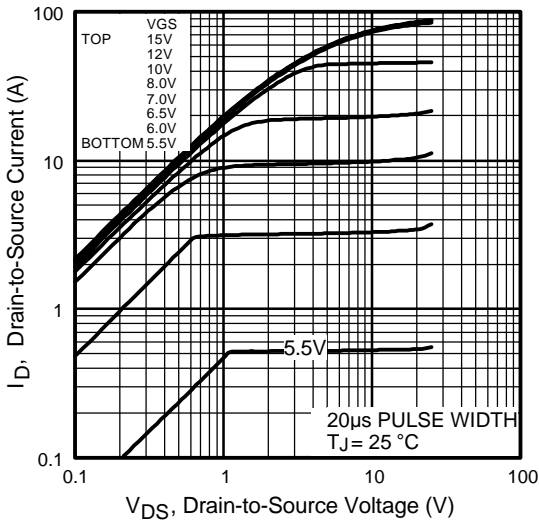

Fig 1. Typical Output Characteristics

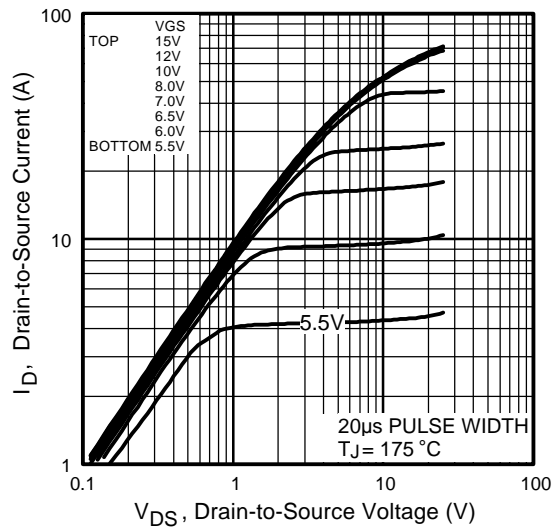

Fig 2. Typical Output Characteristics

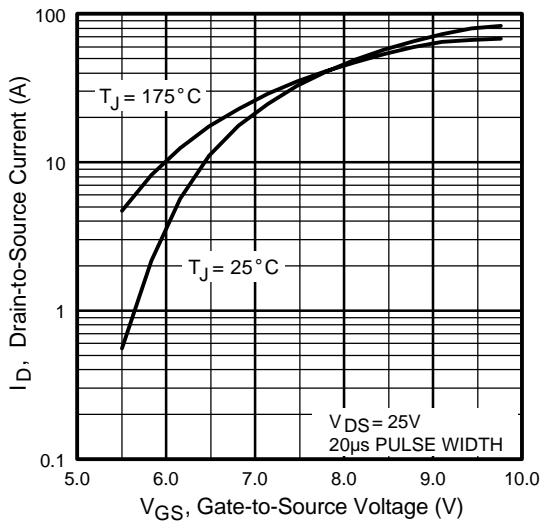

Fig 3. Typical Transfer Characteristics

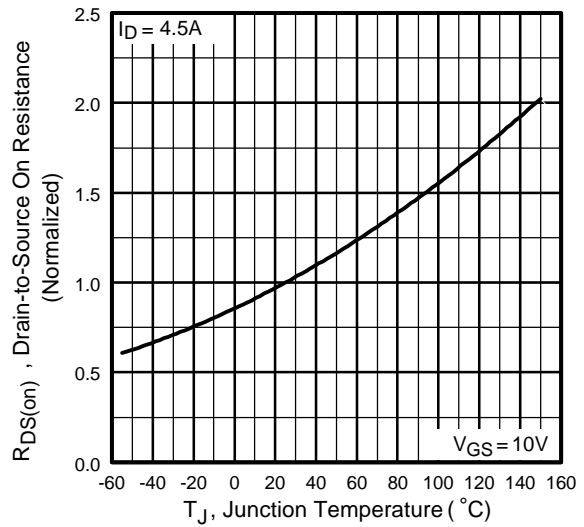

Fig 4. Normalized On-Resistance Vs. Temperature

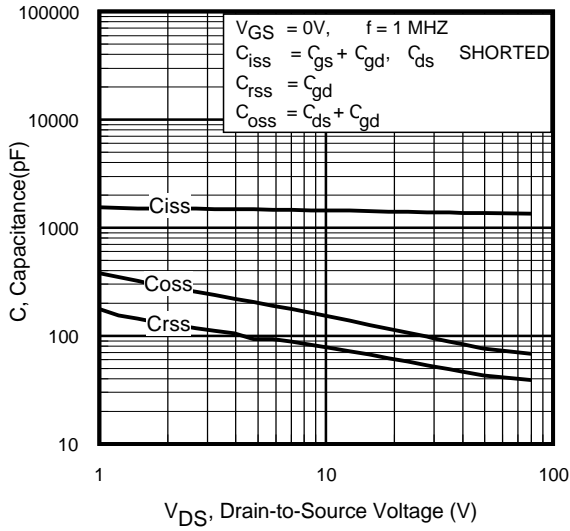

Fig 5. Typical Capacitance Vs. Drain-to-Source Voltage

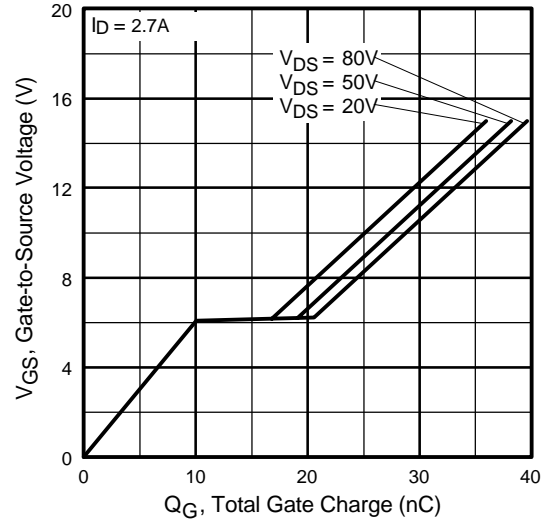

Fig 6. Typical Gate Charge Vs. Gate-to-Source Voltage

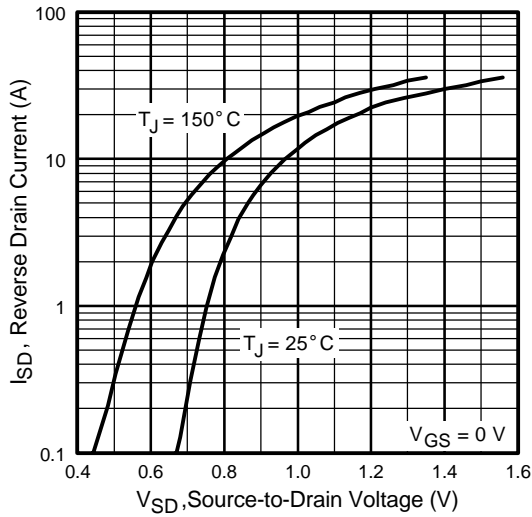

Fig 7. Typical Source-Drain Diode Forward Voltage

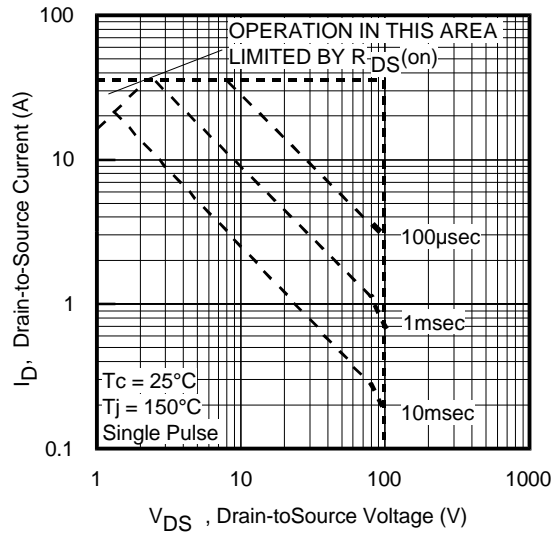

Fig 8. Maximum Safe Operating Area

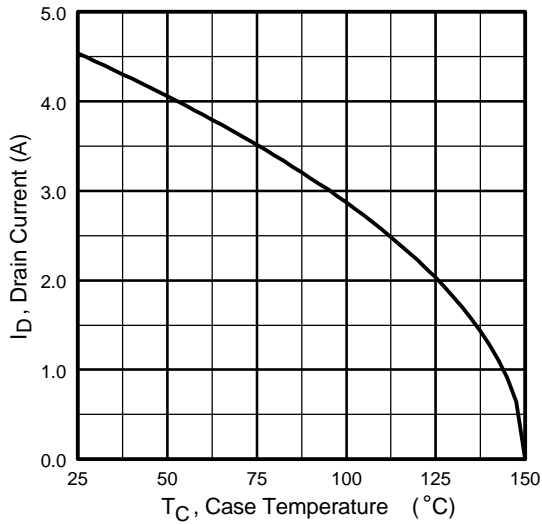

Fig 9. Maximum Drain Current Vs. Ambient Temperature

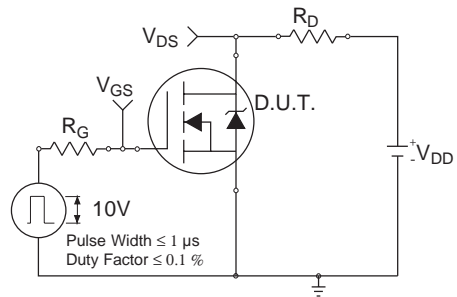

Fig 10a. Switching Time Test Circuit

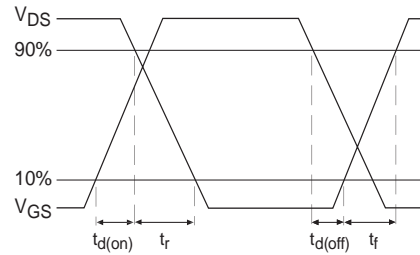

Fig 10b. Switching Time Waveforms

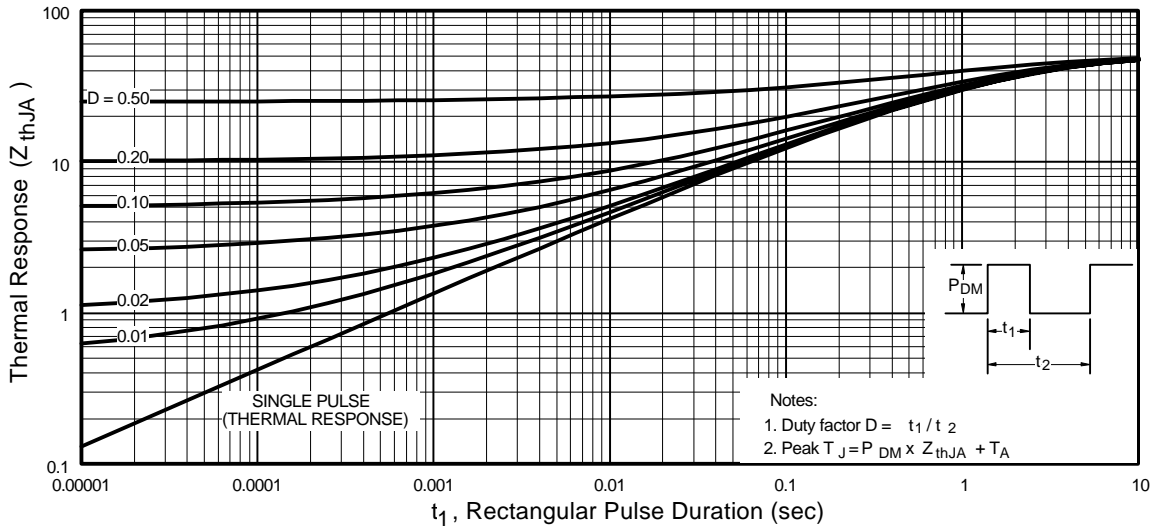

Fig 11. Maximum Effective Transient Thermal Impedance, Junction-to-Ambient

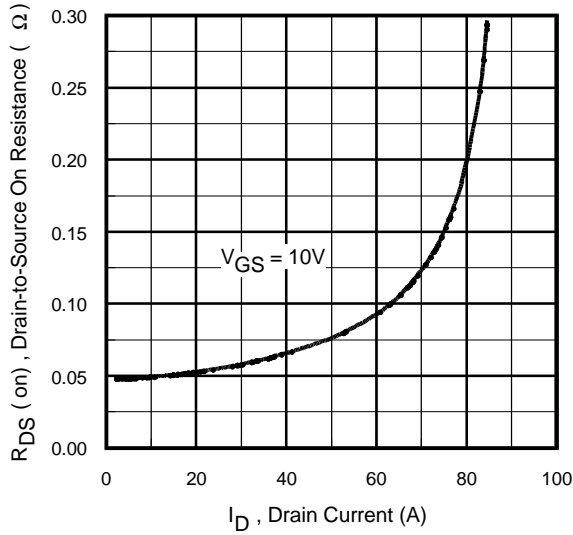

Fig 12. On-Resistance Vs. Drain Current

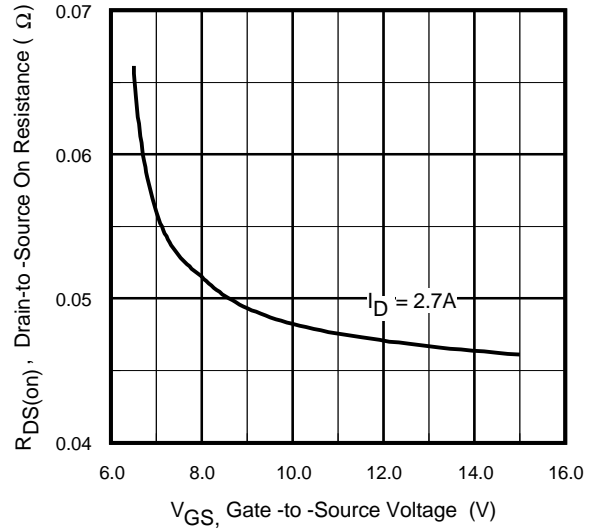

Fig 13. On-Resistance Vs. Gate Voltage

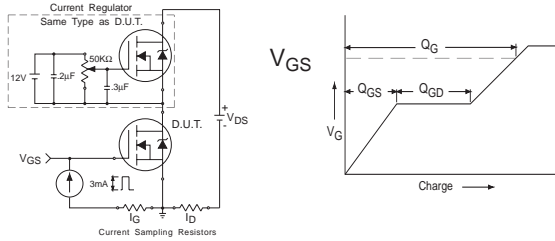

Fig 14a&b. Basic Gate Charge Test Circuit and Waveform

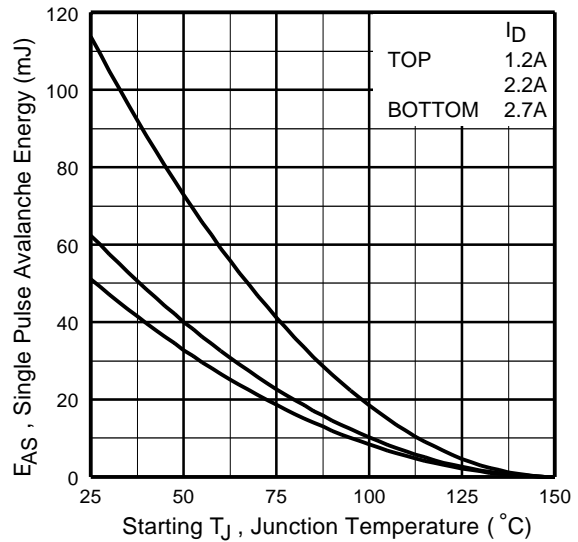

Fig 15c. Maximum Avalanche Energy Vs. Drain Current

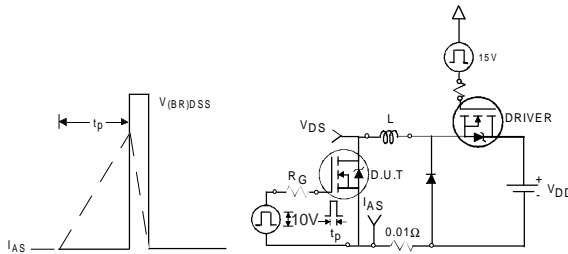
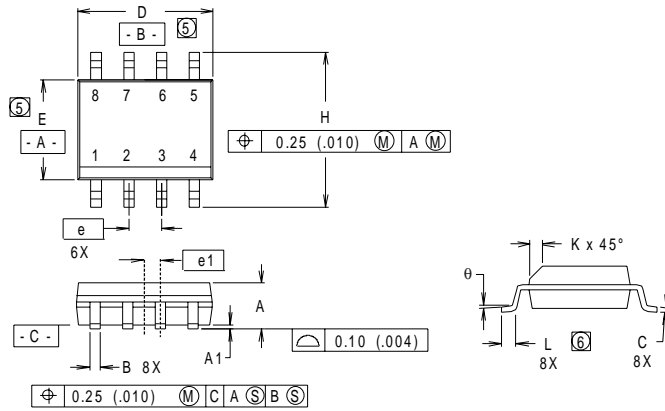

Fig 15a&b. Unclamped Inductive Test circuit and Waveforms

SO-8 Package Details



DIM	INCHES		MILLIMETERS	
	MIN	MAX	MIN	MAX
A	.0532	.0688	1.35	1.75
A1	.0040	.0098	0.10	0.25
B	.014	.018	0.36	0.46
C	.0075	.0098	0.19	0.25
D	.189	.196	4.80	4.98
E	.150	.157	3.81	3.99
e	.050 BASIC		1.27 BASIC	
e1	.025 BASIC		0.635 BASIC	
H	.2284	.2440	5.80	6.20
K	.011	.019	0.28	0.48
L	0.16	.050	0.41	1.27
θ	0°	8°	0°	8°

RECOMMENDED FOOTPRINT



NOTES:

1. DIMENSIONING AND TOLERANCING PER ANSI Y14.5M-1982.
2. CONTROLLING DIMENSION : INCH.
3. DIMENSIONS ARE SHOWN IN MILLIMETERS (INCHES).
4. OUTLINE CONFORMS TO JEDEC OUTLINE MS-012AA.
- (5) DIMENSION DOES NOT INCLUDE MOLD PROTRUSIONS
MOLD PROTRUSIONS NOT TO EXCEED 0.25 (.006).
- (6) DIMENSIONS IS THE LENGTH OF LEAD FOR SOLDERING TO A SUBSTRATE..

SO-8 Part Marking

EXAMPLE: THIS IS AN IRF7101



IRF7474

International
IR Rectifier

SO-8 Tape and Reel

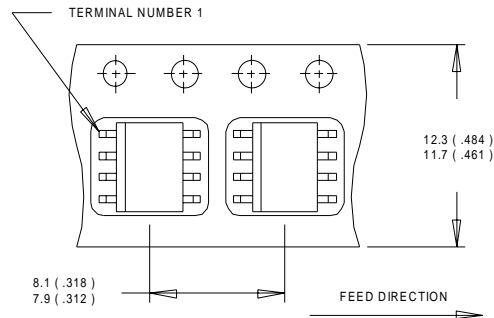

- NOTES:
1. CONTROLLING DIMENSION : MILLIMETER.
 2. ALL DIMENSIONS ARE SHOWN IN MILLIMETERS(INCHES).
 3. OUTLINE CONFORMS TO EIA-481 & EIA-541.

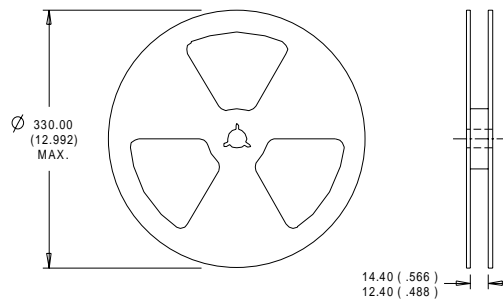

- NOTES :
1. CONTROLLING DIMENSION : MILLIMETER.
 2. OUTLINE CONFORMS TO EIA-481 & EIA-541.

Notes:

- ① Repetitive rating; pulse width limited by max. junction temperature.
- ② Starting $T_J = 25^\circ\text{C}$, $L = 14\text{mH}$
 $R_G = 25\Omega$, $I_{AS} = 2.7\text{A}$.
- ③ Pulse width $\leq 400\mu\text{s}$; duty cycle $\leq 2\%$.
- ④ When mounted on 1 inch square copper board
- ⑤ C_{OSS} eff. is a fixed capacitance that gives the same charging time as C_{OSS} while V_{DS} is rising from 0 to 80% V_{DSS}
- ⑥ $I_{SD} \leq 2.7\text{A}$, $di/dt \leq 210\text{A}/\mu\text{s}$, $V_{DD} \leq V_{(BR)DSS}$,
 $T_J \leq 150^\circ\text{C}$

Data and specifications subject to change without notice.
This product has been designed and qualified for the Industrial market.
Qualification Standards can be found on IR's Web site.

International
IR Rectifier

IR WORLD HEADQUARTERS: 233 Kansas St., El Segundo, California 90245, USA Tel: (310) 252-7105
TAC Fax: (310) 252-7903

Visit us at www.irf.com for sales contact information. 9/01

www.irf.com