



## TELEDYNE RELAYS

### ULTRAMINIATURE MAGNETIC LATCHING TO-5 RELAYS SPDT DC TO C BAND

### SERIES RF341

**NEW**

#### DESCRIPTION

The RF341 series relay is an ultraminiature, hermetically sealed, magnetic latching relay featuring extremely low intercontact capacitance for exceptional RF performance well into the C band. It's low profile and small size make it ideal for applications where extreme packaging density and/or close PC board spacing are required. Due to its minimal mass, many relays may be used to configure replacements for bulkier switching solutions at a substantial savings in weight

The basic operating mechanism is similar to the TO-5 422 series relay. In addition, the RF341 design has been optimized by increasing the distance between the set/reset contacts. This design improvement makes these unique relays the perfect choice for use in RF attenuators, RF switching matrices and other RF applications requiring high isolation, low insertion loss and low VSWR.

The following unique construction features and manufacturing techniques provide overall high reliability

and excellent resistance to environmental extremes:

- Minimum mass components and welded construction provide maximum resistance to shock and vibration.
- Uni-frame motor design provides high magnetic efficiency and mechanical rigidity.
- Advanced cleaning techniques provide maximum assurance of internal cleanliness.
- Gold plated precious metal contacts ensure reliable, low level switching.

The RF341 relay is ideally suited for applications where power dissipation must be minimized. The relays can be operated with a short duration pulse. After the contacts have transferred, no external holding power is required.

The magnetic latching feature of the RF341 series provides a non volatile memory capability since the relays will not reset upon removal of coil power.

#### PRINCIPLE OF OPERATION

Energizing Coil B produces a magnetic field opposing the holding

Circuit B. As this net holding force decreases, the attractive force in the air gap of Circuit A, which also results from the flux of the permanent magnet, becomes great enough to break the armature free of Core B and snap it in position against Core A. The armature then remains in this position upon removal of power from Coil B, but will snap back to position B upon energizing Coil A. Since operation depends upon cancellation of a magnetic field, it is necessary to apply the correct polarity to the relay coils as indicated on the relay schematic.

When latching relays are installed in equipment, the latch and reset coils should not be pulsed simultaneously. Coils should not be pulsed with less than the nominal coil voltage and the pulse width should be a minimum of three times the specified operate time of the relay. If these conditions are not observed, it is possible for the relay to be in a magnetically neutral position. Should this happen however, pulsing one coil or the other, as prescribed, will bring the relay back into proper operating condition.

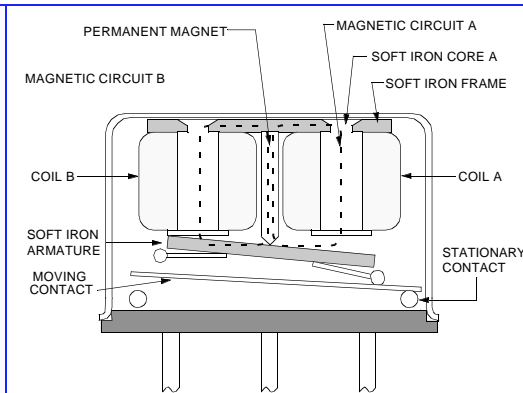

#### ENVIRONMENTAL AND PHYSICAL SPECIFICATIONS

<b>Temperature ( Ambient )</b>	-55° C to +85° C
<b>Vibration</b>	30G to 2,000 Hz (note 1)
<b>Shock</b>	75G for 6 ms (note 1)
<b>Acceleration</b>	50G
<b>Enclosure</b>	Hermetically sealed
<b>Weight</b>	0.09 oz. (2.52 gm) max.

# Typical RF Characteristics

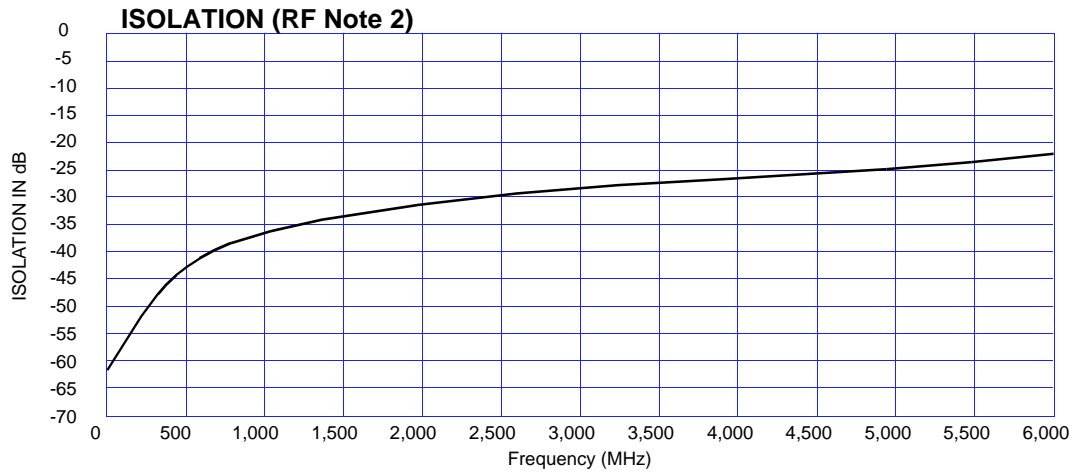
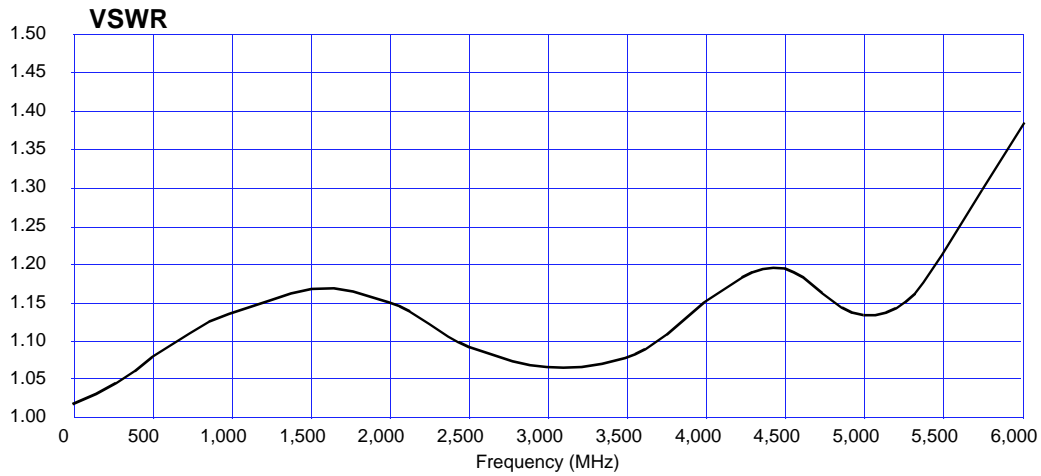
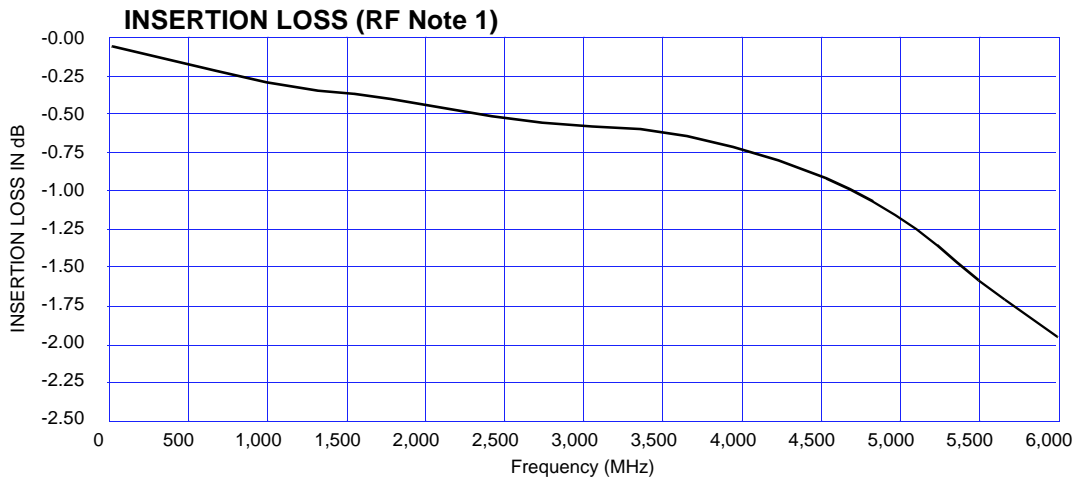

## RF Notes:

1. Data represents an average between the typical reading of pins 8 and 6 (closed, coil A last energized) and pins 8 and 1 (closed, coil B last energized)
2. Data represents an average between the typical reading of pins 8 and 6 (open, coil B last energized) and pins 8 and 1 (open, coil A last energized)
3. Test conditions:
  - a. Fixture: .031" copper clad, reinforced PTFE, RT/duroid<sup>®</sup> 6002 with SMA connectors. (RT/duroid<sup>®</sup> is a registered trademark of Rogers Corporation).
  - b. Relay header is in contact with but not soldered to ground plane nor connected to ground via ground pin.
  - c. Test performed at room ambient temperature.
  - d. Terminals not tested were terminated with 50 ohm load.
  - e. Contact signal level: 20 dBm.
4. Data presented herein represents typical characteristics and is not intended for use as specification limits.

# SERIES RF341

## GENERAL ELECTRICAL SPECIFICATIONS (@ 25° C) (Notes 2 & 3)

<b>Contact arrangement</b>	1 Form C (SPDT)	
<b>Rated duty</b>	Continuous	
<b>Contact resistance</b>	.15 ohms max. initial. After life, .25 ohms (measured 1/8" from the header)	
<b>Contact load rating (DC)</b>	Low Level: 10 to 50 µA 10 to 50 mV	
<b>Contact life rating</b>	10,000,000 cycles (typical) at low level	
<b>Coil operating power (@nominal rated voltage)</b>	<b>5 volt</b>	410mW
	<b>12 volt</b>	288mW
	<b>26.5 volt</b>	351mW
<b>Operate time</b>	2.0 ms. max. at nominal rated coil voltage	
<b>Minimum operate pulse</b>	6.0 ms. max. at nominal voltage	
<b>Intercontact Capacitance</b>	0.4 pF typical	
<b>Insulation resistance</b>	10,000 MΩ min. between mutually isolated terminals	
<b>Dielectric strength</b>	350 VRMS/60 Hz @ atmospheric pressure	

## DETAILED ELECTRICAL SPECIFICATION (@ 25 °C) (Note 2)

BASE PART NUMBER		RF341-5	RF341-12	RF341-26
<b>Coil voltage (VDC)</b>	<b>Nom.</b>	5.0	12.0	26.5
	<b>Max.</b>	6.0	16.0	32.0
<b>Coil resistance (ohms ±20%)</b>		61	500	2,000
<b>Set &amp; reset voltage (VDC max)</b>		3.5	9.0	18.0

### OUTLINE DIMENSIONS AND SCHEMATIC DIAGRAM

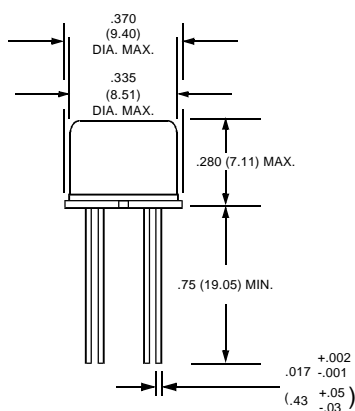

**External Dimensions**

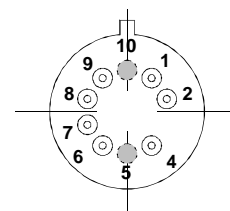
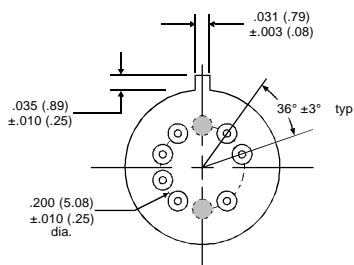

**TERMINAL NUMBERING**

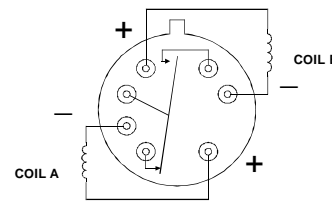

**SCHEMATIC**

TERMINAL LOCATION, PIN NUMBERING AND SCHEMATIC ARE VIEWED FROM THE TERMINALS

SCHEMATIC IS SHOWN WITH COIL A LAST ENERGIZED

### Notes

1. Relays will exhibit no contact chatter in excess of 10 µs or transfer in excess of 1 µs.
2. Unless otherwise specified, parameters are initial values.
3. Characteristics shown as "typical" are based on available data and are best estimates. No on going verification tests are performed.
4. Pin positions 5 and 10 are recesses in the header for ground pin options (ground pins not shown).
5. To order ground pin options add Y (pin 5 position) or Z (pin 10 position) to the part base part number. Ex. RF341Y-5
6. Contact Teledyne Relays for Hi-Rel Screening/Program options.