

POWER OPTO™ Isolator

2 Amp Zero-Cross Triac Output

This device consists of a gallium arsenide infrared emitting diode optically coupled to a zero-cross triac driver circuit and a power triac. It is capable of driving a load of up to 2 amp (rms) directly, on line voltages from 20 to 140 volts ac (rms).

- Provides Normally Open Solid State A.C. Output With 2 Amp Rating
- 60 Amp Single Cycle Surge Capability
- Zero-Voltage Turn-on and Zero-Current Turn-off
- High Input-Output Isolation of 3750 vac (rms)
- Static dv/dt Rating of 400 Volts/μs Guaranteed
- 2 Amp Pilot Duty Rating Per UL508 ¶1117 (Overload Test) and ¶1118 (Endurance Test) [File No. 129224]
- CSA Approved [File No. CA77170-1].
- SEMKO Approved Certificate #9507228
- Exceeds NEMA 2-230 and IEEEE472 Noise Immunity Test Requirements (See Fig.15)

DEVICE RATINGS ($T_A = 25^\circ\text{C}$ unless otherwise noted)

Rating	Symbol	Value	Unit
--------	--------	-------	------

INPUT LED

Forward Current — Maximum Continuous	I_F	50	mA
Forward Current — Maximum Peak (PW = 100μs, 120 pps)	$I_{F(pk)}$	1.0	A
Reverse Voltage — Maximum	V_R	6.0	V

OUTPUT TRIAC

Off-State Output Terminal Voltage — Maximum ⁽¹⁾	V_{DRM}	400	Vac(pk)
Recommended Operating Voltage Range (f = 47 – 63 Hz)	V_T	20 to 140	Vac(rms)
On-State Current Range (Free Air, Power Factor ≥ 0.3)	$I_T(rms)$	0.01 to 2.0	A
Non-Repetitive Peak Overcurrent — Max (f = 60 Hz, t = 1.0 sec)	I_{TSM}^1	24	A
Non-Repetitive Single Cycle Surge Current — Maximum Peak (t = 16.7 ms)	I_{TSM}^2	70	A
Main Terminal Fusing Current (t = 8.3 ms)	I^2T	26	A ² sec
Load Power Factor Range	PF	0.3 to 1.0	—
Junction Temperature Range	T_J	-40 to 125	°C

TOTAL DEVICE

Input-Output Isolation Voltage — Maximum ⁽²⁾ 47 – 63 Hz, 1 sec Duration	V_{ISO}	3750	Vac(rms)
Thermal Resistance — Power Triac Junction to Case (See Fig. 16)	$R_{\theta JC}$	8.0	°C/W
Ambient Operating Temperature Range	T_{oper}	-40 to +100	°C
Storage Temperature Range	T_{stg}	-40 to +150	°C
Lead Soldering Temperature — Maximum (1/16" From Case, 10 sec Duration)	—	260	°C

1. Test voltages must be applied within dv/dt rating.
2. Input-Output isolation voltage, V_{ISO} , is an internal device dielectric breakdown rating. For this test, pins 2, 3 and the heat tab are common, and pins 7 and 9 are common.

Preferred devices are Motorola recommended choices for future use and best overall value.

MOC2A40-10

MOC2A40-5*

*Motorola Preferred Device

OPTOISOLATOR
2 AMP ZERO CROSS
TRIAC OUTPUT
400 VOLTS



DEVICE SCHEMATIC

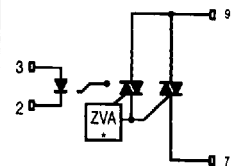

* Zero Voltage Activate Circuit

- 1, 4, 5, 6, 8. NO PIN
2. LED CATHODE
3. LED ANODE
7. MAIN TERMINAL 2
9. MAIN TERMINAL 1

MOC2A40-10 MOC2A40-5

ELECTRICAL CHARACTERISTICS ($T_A = 25^\circ\text{C}$ unless otherwise noted)

Characteristic	Symbol	Min	Typ	Max	Unit
INPUT LED					
Forward Voltage ($I_F = 10\text{ mA}$)	V_F	1.00	1.17	1.50	V
Reverse Leakage Current ($V_R = 6.0\text{ V}$)	I_R	—	1.0	100	μA
Capacitance	C	—	18	—	pF

OUTPUT TRIAC

Off-State Leakage, Either Direction ($I_F = 0, V_{DRM} = 400\text{ V}$)	I_{DRM}	—	0.25	10	μA
Critical Rate of Rise of Off-State Voltage (Static) $V_{in} = 200\text{ vac(pk)}^{(1)(2)}$	$dv/dt(s)$	400	—	—	$\text{V}/\mu\text{s}$
Holding Current, Either Direction ($I_F = 0, V_D = 12\text{ V}, I_T = 200\text{ mA}$)	I_H	—	10	—	mA

COUPLED

LED Trigger Current Required to Latch Output Either Direction (Main Terminal Voltage = 2.0 V) ⁽³⁾⁽⁴⁾	MOC2A40-10 MOC2A40-5	$I_{FT(on)}$ $I_{FT(on)}$	— —	7.0 3.5	10 5.0	mA mA
On-State Voltage, Either Direction ($I_F = \text{Rated } I_{FT(on)}, I_{TM} = 2.0\text{ A}$)		V_{TM}	—	0.96	1.3	V
Inhibit Voltage, Either Direction ($I_F = \text{Rated } I_{FT(on)}$) ⁽⁵⁾ (Main Terminal Voltage above which device will not Trigger)		V_{INH}	—	8.0	10	V
Commutating dv/dt (Rated $V_{DRM}, I_T = 30\text{ mA} - 2.0\text{ A(rms)}$, $T_A = -40 \pm 100^\circ\text{C}, f = 60\text{ Hz}$) ⁽²⁾		$dv/dt(c)$	5.0	—	—	$\text{V}/\mu\text{s}$
Common-mode Input-Output dv/dt ⁽²⁾		$dv/dt(cm)$	—	40,000	—	$\text{V}/\mu\text{s}$
Input-Output Capacitance ($V = 0, f = 1.0\text{ MHz}$)		C_{ISO}	—	1.3	—	pF
Isolation Resistance ($V_{I-O} = 500\text{ V}$)		R_{ISO}	10^{12}	10^{14}	—	Ω

- Per EIA/NARM standard RS-443, with $V_p = 200\text{ V}$, which is the instantaneous peak of the maximum operating voltage.
- Additional dv/dt information, including test methods, can be found in Motorola applications note AN1048/D, Figure 43.
- All devices are guaranteed to trigger at an I_F value less than or equal to the max I_{FT} . Therefore, the recommended operating I_F lies between the device's maximum $I_{FT(on)}$ limit and the Maximum Rating of 50 mA.
- Current-limiting resistor required in series with LED.
- Also known as "Zero Voltage Turn-On".

TYPICAL CHARACTERISTICS

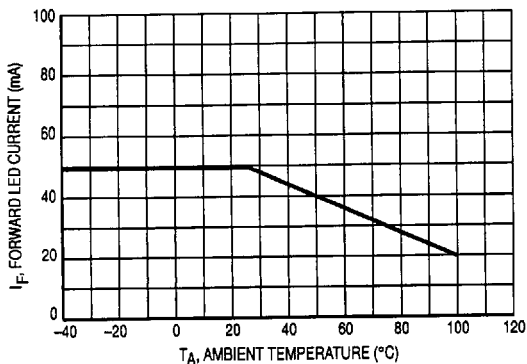

Figure 1. Maximum Allowable Forward LED Current versus Ambient Temperature

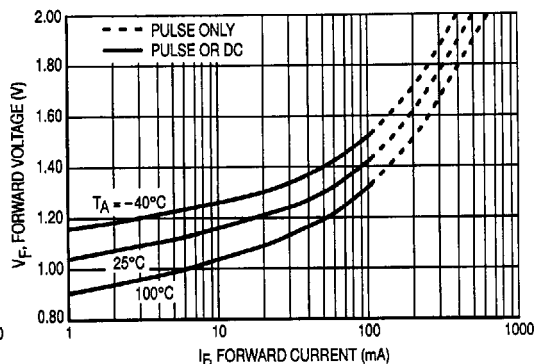

Figure 2. LED Forward Voltage versus LED Forward Current

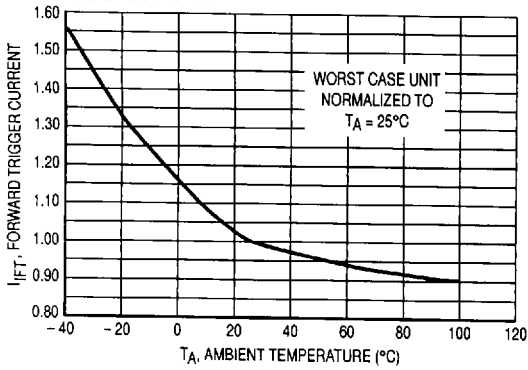

Figure 3. Forward LED Trigger Current versus Ambient Temperature

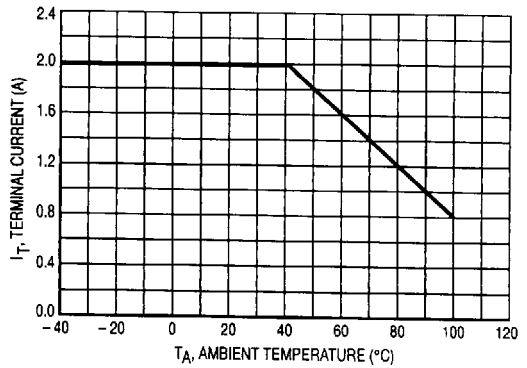

Figure 4. Maximum Allowable On-State RMS Output Current (Free Air) versus Ambient Temperature

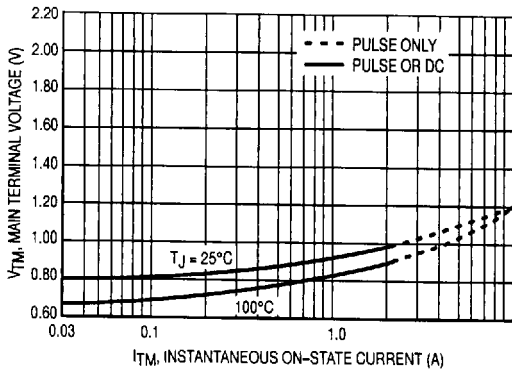

Figure 5. On-State Voltage Drop versus Output Terminal Current

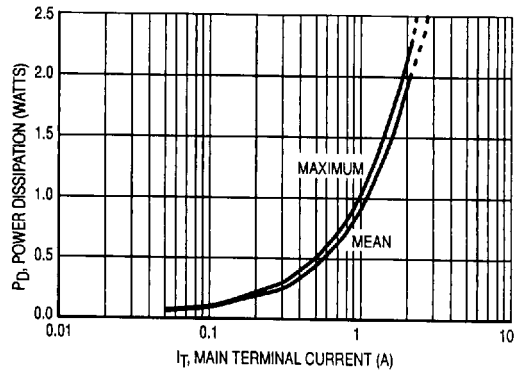

Figure 6. Power Dissipation versus Main Terminal Current

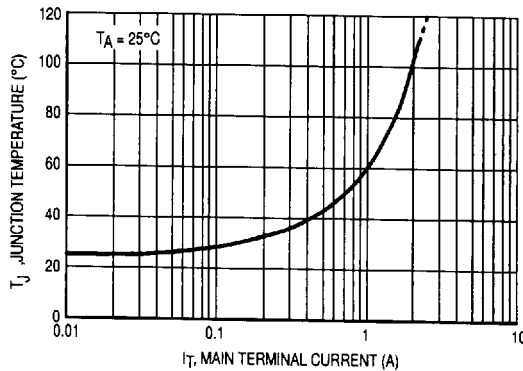

Figure 7. Junction Temperature versus Main Terminal RMS Current (Free Air)

MOC2A40-10 MOC2A40-5

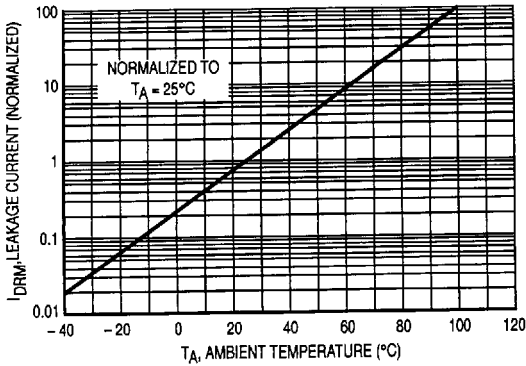

Figure 8. Leakage with LED Off versus Ambient Temperature

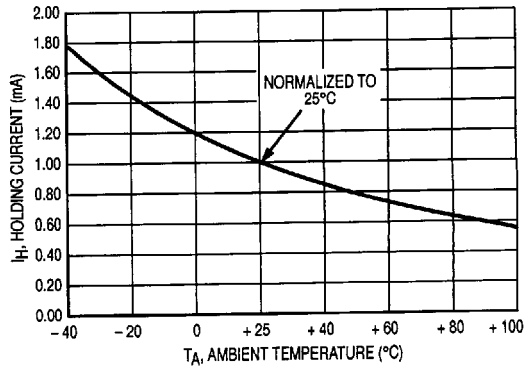

Figure 9. Holding Current versus Ambient Temperature

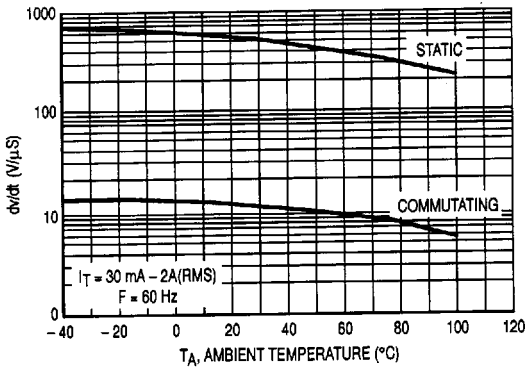

Figure 10. dv/dt versus Ambient Temperature

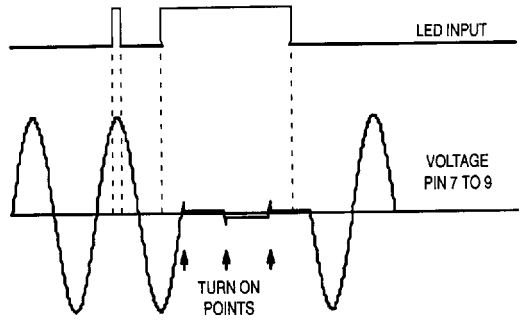

Figure 11. Operating Waveforms

*ZERO VOLTAGE ACTIVATE CIRCUIT

Select the value of R1 according to the following formulas:

- [1] $R1 = (V_{CC} - V_F) / \text{Max. } I_{FT} \text{ (on) per spec.}$
- [2] $R1 = (V_{CC} - V_F) / 0.050$

Typical values for C1 and R2 are 0.01 μF and 39 Ω , respectively. You may adjust these values for specific applications. The maximum recommended value of C1 is 0.022 μF . See application note AN1048 for additional information on component values.

The MOV may or may not be needed depending upon the characteristics of the applied ac line voltage. For applications where line spikes may exceed the 400 V rating of the MOC2A40, an MOV is required.

Figure 12. Typical Application Circuit

Use care to maintain the minimum spacings as shown. Safety and regulatory requirements dictate a minimum of 8.0 mm between the closest points between input and output conducting paths, Pins 3 and 7. Also, 0.070 inches distance is required between the two output Pins, 7 and 9.

Keep pad sizes on Pins 7 and 9 as large as possible for optimal performance.

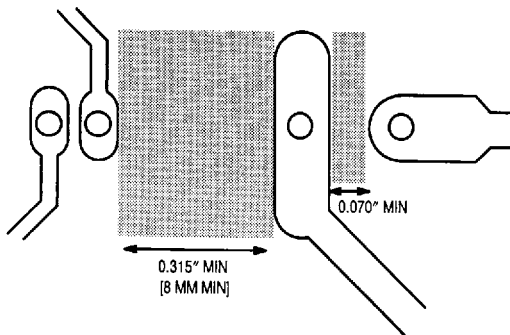

Figure 13. PC Board Layout Recommendations

Each device, when installed in the circuit shown in Figure 15, shall be capable of passing the following conducted noise tests:

- IEEE 472 (2.5 KV)
- Lamp Dimmer (NEMA Part DC33, § 3.4.2.1)
- NEMA ICS 2-230.45 Showering Arc
- MIL-STD-461A CS01, CS02 and CS06

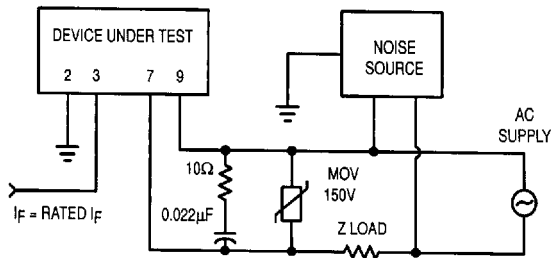
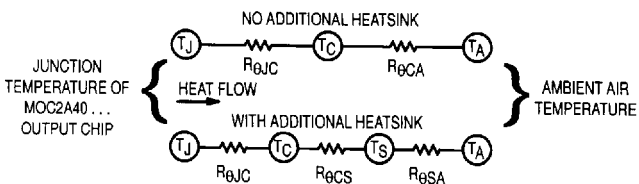

Figure 14. Test Circuit for Conducted Noise Tests



Terms in the model signify:

- T_A = Ambient temperature
- T_S = Optional additional heat sink temperature
- T_C = Case temperature
- T_J = Junction temperature
- P_D = Power dissipation
- $R_{\theta SA}$ = Thermal resistance, heat sink to ambient
- $R_{\theta CA}$ = Thermal resistance, case to ambient
- $R_{\theta CS}$ = Thermal resistance, heat sink to case
- $R_{\theta JC}$ = Thermal resistance, junction to case

Values for thermal resistance components are: $R_{\theta CA} = 36^\circ\text{C/W/in}$ maximum
 $R_{\theta JC} = 8.0^\circ\text{C/W}$ maximum

The design of any additional heatsink will determine the values of $R_{\theta SA}$ and $R_{\theta CS}$.

$$T_C - T_A = P_D (R_{\theta CA})$$

$$= P_D (R_{\theta JC}) + R_{\theta SA}, \text{ where } P_D = \text{Power Dissipation in Watts.}$$

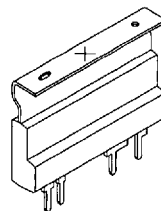

Thermal measurements of $R_{\theta JC}$ are referenced to the point on the heat tab indicated with an 'X'. Measurements should be taken with device orientated along its vertical axis.

Figure 15. Approximate Thermal Circuit Model

PACKAGE DIMENSIONS

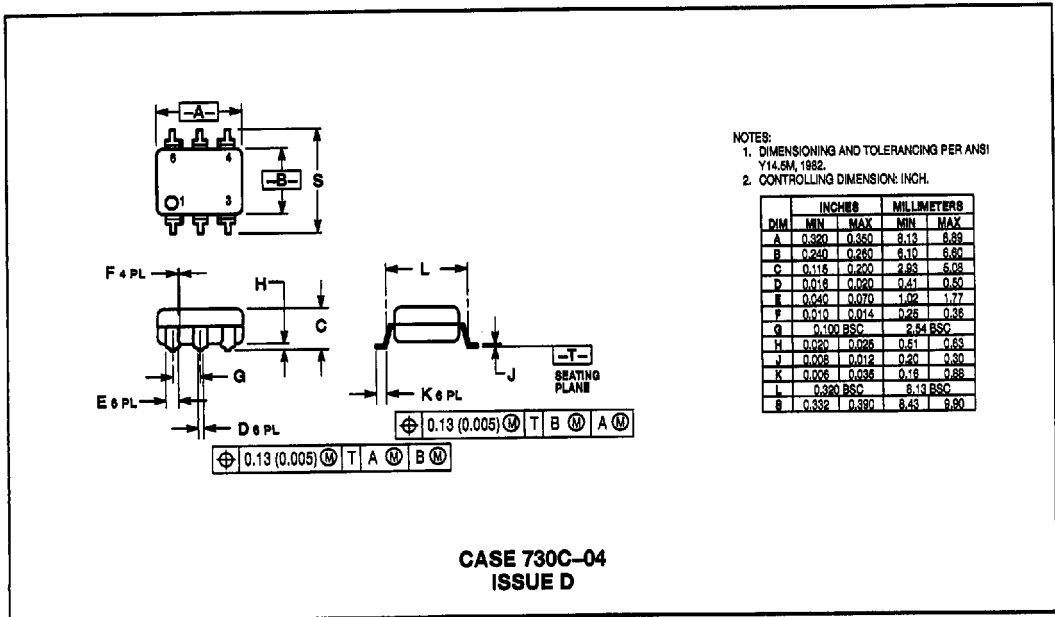
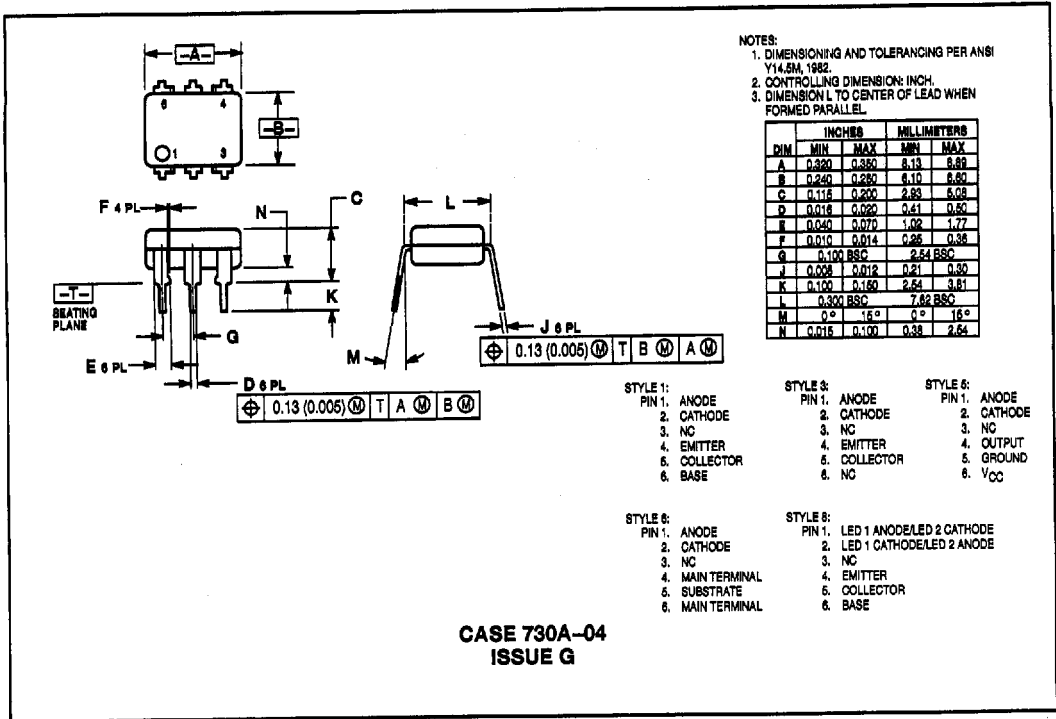

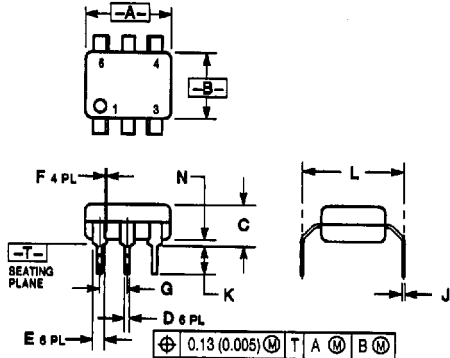

- NOTES:
 1. DIMENSIONING AND TOLERANCING PER ANSI Y14.5M, 1982.
 2. CONTROLLING DIMENSION: INCH.
 3. DIMENSION L TO CENTER OF LEAD WHEN FORMED PARALLEL.

DIM	INCHES		MILLIMETERS	
	MIN	MAX	MIN	MAX
A	0.320	0.350	8.13	8.89
B	0.240	0.260	6.10	6.60
C	0.115	0.200	2.93	5.08
D	0.016	0.020	0.41	0.50
E	0.040	0.070	1.02	1.77
F	0.010	0.014	0.25	0.38
G	0.100 BSC		2.54 BSC	
J	0.008	0.012	0.21	0.30
K	0.100	0.160	2.54	4.11
L	0.400	0.425	10.16	10.80
N	0.015	0.040	0.38	1.02

**CASE 730D-05
 ISSUE D**

PACKAGE DIMENSIONS

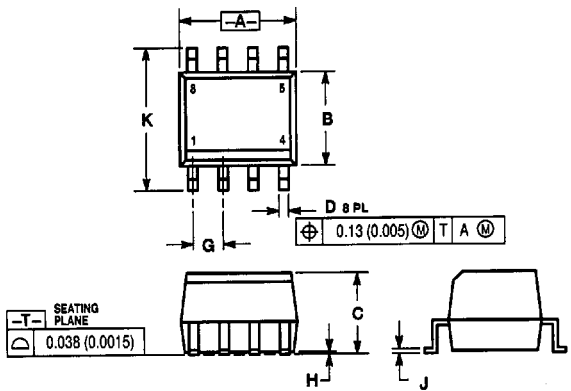

- NOTES:
 1. DIMENSIONING AND TOLERANCING PER ANSI Y14.5M, 1982.
 2. CONTROLLING DIMENSION: INCH.

DIM	INCHES		MILLIMETERS	
	MIN	MAX	MIN	MAX
A	0.192	0.202	4.83	5.13
B	0.144	0.164	3.65	4.16
C	0.128	0.143	3.13	3.63
D	0.011	0.021	0.28	0.53
G	0.050 BSC		1.27 BSC	
H	0.003	0.008	0.08	0.20
J	0.006	0.010	0.16	0.25
K	0.224	0.244	5.69	6.19

STYLE 1: (Single Channel)

- PIN 1. ANODE
- 2. CATHODE
- 3. NC
- 4. NC
- 5. EMITTER
- 6. COLLECTOR
- 7. BASE
- 8. NC

STYLE 2: (AC Input)

- PIN 1. INPUT
- 2. INPUT
- 3. NC
- 4. NC
- 5. EMITTER
- 6. COLLECTOR
- 7. BASE
- 8. NC

STYLE 3: (Dual Channel)

- PIN 1. ANODE 1
- 2. CATHODE 1
- 3. ANODE 2
- 4. CATHODE 2
- 5. EMITTER 2
- 6. COLLECTOR 2
- 7. EMITTER 1
- 8. COLLECTOR 1

STYLE 4: Single Channel—Baseless

- PIN 1. ANODE
- 2. CATHODE
- 3. NC
- 4. NC
- 5. EMITTER
- 6. COLLECTOR
- 7. NC
- 8. NC

**CASE 846-01
 ISSUE B**