

## ADP3342

### FEATURES

**Accuracy over Line and Load:  $\pm 4.0\%$  @ 25°C,  
 $\pm 5\%$  over Temperature**

**Ultralow Dropout Voltage: 300 mV (Typ) @ 300 mA**

**Requires Only  $C_O = 1.0 \mu\text{F}$  for Stability  
anyCAP = Stable with any Type of Capacitor  
(Including MLCC)**

**Current and Thermal Limiting**

**Low Shutdown Current:  $< 2 \mu\text{A}$**

**$1.7 \text{ V} \leq V_{IN} \leq 6 \text{ V}$**

**$2.8 \text{ V} \leq V_{CC} \leq 6 \text{ V}$**

**$V_{OUT} = 1.2 \text{ V} \pm 5\%$**

**$-40^\circ\text{C}$  to  $+100^\circ\text{C}$  Ambient Temperature Range**

**Ultrasmall Thermally Enhanced 8-Lead MSOP Package**

### APPLICATIONS

Notebook PCs

Desktop PCs

### FUNCTIONAL BLOCK DIAGRAM

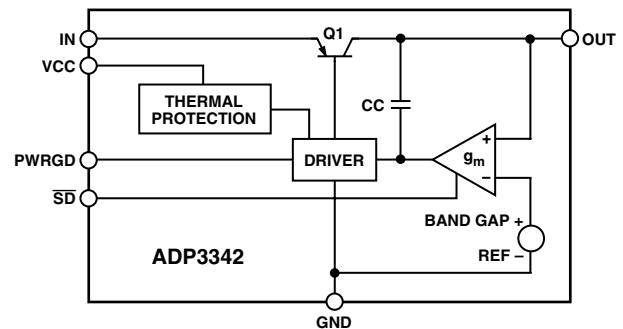

### GENERAL DESCRIPTION

The ADP3342 is a unique member of the ADP330x family of precision low dropout anyCAP voltage regulators. The ADP3342 operates with an input voltage range of 1.7 V to 6 V and delivers a continuous load current up to 300 mA. In order to support the ability to regulate from such a low input voltage, the power rail to the IC, VCC, has been split off from the main power rail,  $V_{IN}$ , from which the output is powered.

The ADP3342 stands out from the conventional LDOs with the lowest thermal resistance of any MSOP-8 package and an enhanced process that enables it to offer performance advantages beyond its competition. Its patented design requires only a  $1.0 \mu\text{F}$  output capacitor for stability. This device is insensitive to output capacitor Equivalent Series Resistance (ESR) and is stable with any good quality capacitor, including ceramic (MLCC) types for space-restricted applications. The dropout voltage of the ADP3342 is only 190 mV (typical) at 300 mA. This device also includes a safety current limit, thermal overload protection, and a shutdown control pin.

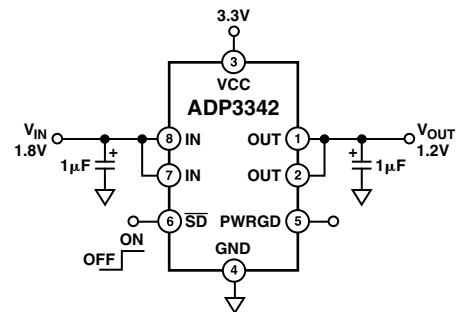

Figure 1. Typical Application Circuit

anyCAP is a registered trademark of Analog Devices, Inc.

### REV. A

Information furnished by Analog Devices is believed to be accurate and reliable. However, no responsibility is assumed by Analog Devices for its use, nor for any infringements of patents or other rights of third parties that may result from its use. No license is granted by implication or otherwise under any patent or patent rights of Analog Devices.

# ADP3342—SPECIFICATIONS<sup>1</sup> (VCC = 3.0 V, VIN = 1.8 V, CIN = COUT = 1 μF, TA = 0°C to +100°C and TA = -40°C to +100°C, unless otherwise noted.)

Parameter	Symbol	Conditions	Min	Typ	Max	Unit	
<b>OUTPUT</b>							
Voltage Accuracy	V <sub>OUT</sub>	VCC = 2.8 V to 6 V, V <sub>IN</sub> = 1.7 V to 6 V I <sub>L</sub> = 0.1 mA to 300 mA T <sub>A</sub> = 25°C	-4.0		+4.0	%	
		VCC = 2.8 V to 6 V, V <sub>IN</sub> = 1.7 V to 6 V I <sub>L</sub> = 0.1 mA to 300 mA T <sub>A</sub> = -40°C to +100°C	-5.0		+5.0	%	
Line Regulation		VCC = 2.8 V to 6 V, V <sub>IN</sub> = 1.7 V to 6 V T <sub>A</sub> = 25°C		0.04		mV/V	
Load Regulation		I <sub>L</sub> = 0.1 mA to 300 mA T <sub>A</sub> = 25°C		0.12		mV/mA	
Dropout Voltage	V <sub>DROP</sub>	V <sub>OUT</sub> = 98% of V <sub>OUTNOM</sub>					
		I <sub>L</sub> = 300 mA		190	450	mV	
		I <sub>L</sub> = 200 mA			125		mV
		I <sub>L</sub> = 100 mA			70		mV
Current Limiting	I <sub>LIM</sub>	VCC = 3 V, V <sub>IN</sub> = 1.8 V		450		mA	
Output Noise	V <sub>NOISE</sub>	f = 10 Hz–100 kHz, C <sub>L</sub> = 1 μF I <sub>L</sub> = 300 mA		60		μV rms	
<b>OPERATING CURRENTS</b>							
Ground Current in Regulation	I <sub>GND</sub>	I <sub>L</sub> = 300 mA, T <sub>A</sub> = -40°C to +100°C		3.0	8.5	mA	
		I <sub>L</sub> = 300 mA, T <sub>A</sub> = 0°C to 100°C		3.0	6.0	mA	
		I <sub>L</sub> = 300 mA, T <sub>A</sub> = 25°C		3.0	4.0	mA	
		I <sub>L</sub> = 200 mA			2.0		mA
		I <sub>L</sub> = 0.1 mA			100	175	μA
VCC Current in Regulation	IVCC	I <sub>L</sub> = 300 mA		100	170	μA	
Ground Current in Shutdown	I <sub>GNDSD</sub>	SD = 0 V, VCC = 6 V, V <sub>IN</sub> = 1.8 V		0.01	2	μA	
<b>SHUTDOWN</b>							
Threshold Voltage	V <sub>THSD</sub>	ON	VCC - 0.9			V	
		OFF			0.6	V	
SD Input Current	I <sub>SD</sub>	0 ≤ SD ≤ 6 V		1.4	7	μA	
Output Current in Shutdown	I <sub>OSD</sub>	T <sub>A</sub> = 25°C, VCC = 6 V, V <sub>IN</sub> = 6 V		0.01	1	μA	
		T <sub>A</sub> = 100°C, VCC = 6 V, V <sub>IN</sub> = 6 V		0.01	2	μA	
<b>PWRGD</b>							
Power Good Output Voltage	I <sub>PWRGDL</sub> V <sub>PWRGDL</sub> <sup>2</sup>	V <sub>PWRGD</sub> = 1.2 V, VCC = 3.0 V	0.85	1.5		mA	
		I <sub>PWRGD</sub> = 300 μA			0.4	V	
Power Good On-Time Delay	V <sub>PWRGDH</sub> <sup>2</sup> TD1 <sup>3</sup>	I <sub>PWRGD</sub> = 300 μA	VCC - 0.4			V	
		I <sub>L</sub> = 3 mA to 300 mA, C <sub>OUT</sub> = 1 μF to 10 μF	5		300	μs	
Power Good Off-Time Delay	TD2 <sup>4</sup> TD3 <sup>5</sup>	I <sub>L</sub> = 3 mA to 300 mA, C <sub>OUT</sub> = 1 μF to 10 μF	50		300	μs	
		I <sub>L</sub> = 3 mA to 300 mA, C <sub>OUT</sub> = 1 μF to 10 μF	0.05		1	μs	
<b>THERMAL PROTECTION</b>							
Shutdown Temperature	TH <sub>PROT</sub>	I <sub>L</sub> = 100 mA		165		°C	

## NOTES

<sup>1</sup>Ambient temperature of 100°C corresponds to a junction temperature of 125°C under typical full load test conditions.

<sup>2</sup>V<sub>PWRGDL</sub>, V<sub>PWRGDH</sub>: Power good output voltages. Guaranteed by design and characterization.

<sup>3</sup>TD1: Delay time from V<sub>OUT</sub> crossing 1 V to PWRGD high. Guaranteed by design.

<sup>4</sup>TD2: Delay time from SD high to PWRGD high. Guaranteed by design.

<sup>5</sup>TD3: Delay time between SD low to PWRGD low. Guaranteed by design.

Specifications subject to change without notice.

### ABSOLUTE MAXIMUM RATINGS\*

Input Supply Voltage	−0.3 V to +13 V
Shutdown Input Voltage	−0.3 V to +13 V
Power Dissipation	Internally Limited
Operating Ambient Temperature Range	−40°C to +100°C
Operating Junction Temperature Range	−40°C to +125°C
$\theta_{JA}$ (2-layer)	157°C/W
$\theta_{JA}$ (4-layer)	121°C/W
$\theta_{JC}$	56°C/W
Storage Temperature Range	−65°C to +150°C
Lead Temperature Range (Soldering 10 sec)	300°C
Vapor Phase (60 sec)	215°C
Infrared (15 sec)	220°C

\*This is a stress rating only; operation beyond these limits can cause the device to be permanently damaged.

### PIN CONFIGURATION

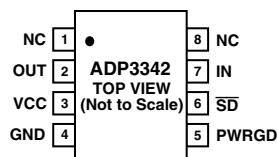

### ORDERING GUIDE

Model	Output Voltage*	Package Option	Marking Code	Temperature Range
ADP3342JRM-REEL7	1.2 V	RM-8 (MSOP-8)	LJA	0°C to 100°C
ADP3342ARM-REEL7	1.2 V	RM-8 (MSOP-8)	LJB	−40°C to +100°C

\*Contact the factory for other output voltage options.

### PIN FUNCTION DESCRIPTIONS

Pin No.	Mnemonic	Function
1, 8	NC	No Connection
2	OUT	Output of the Regulator. Bypass to ground with a 1.0 $\mu$ F or larger capacitor. All pins must be connected together for proper operation.
3	VCC	Supply Voltage
4	GND	Ground Pin
5	PWRGD	Power Good. Used to indicate that output is in regulation.
6	$\overline{SD}$	Active Low Shutdown Pin. Connect to ground to disable the regulator output. When shutdown is not used, this pin should be connected to the input pin.
7	IN	Regulator Input. All pins must be connected together for proper operation.

### CAUTION

ESD (electrostatic discharge) sensitive device. Electrostatic charges as high as 4000 V readily accumulate on the human body and test equipment and can discharge without detection. Although the ADP3342 features proprietary ESD protection circuitry, permanent damage may occur on devices subjected to high energy electrostatic discharges. Therefore, proper ESD precautions are recommended to avoid performance degradation or loss of functionality.



# ADP3342—Typical Performance Characteristics

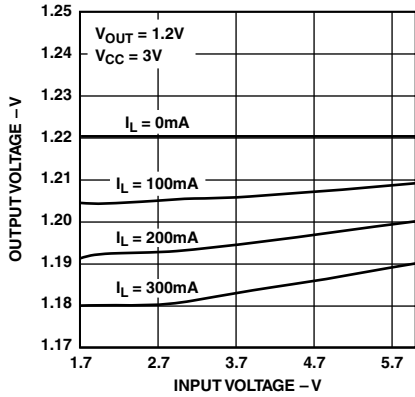

TPC 1. Line Regulation Output Voltage vs. Supply Voltage

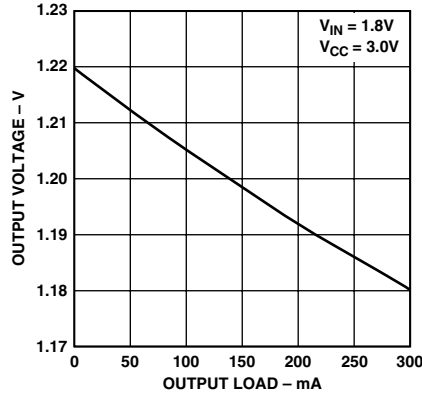

TPC 2. Output Voltage vs. Load Current

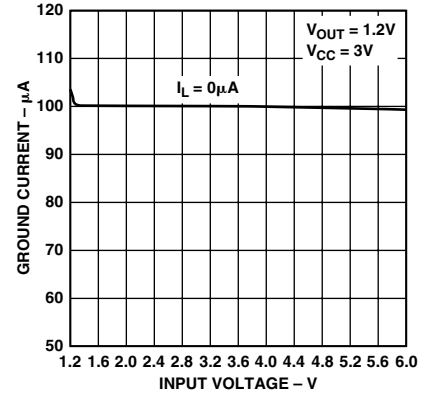

TPC 3. Ground Current vs. Supply Voltage

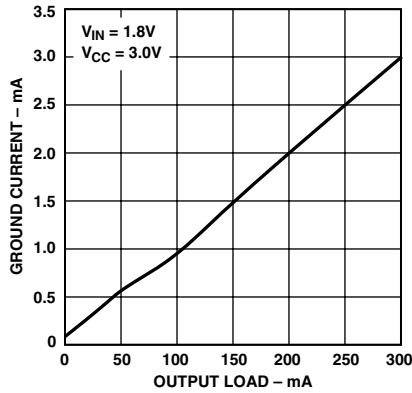

TPC 4. Ground Current vs. Load Current

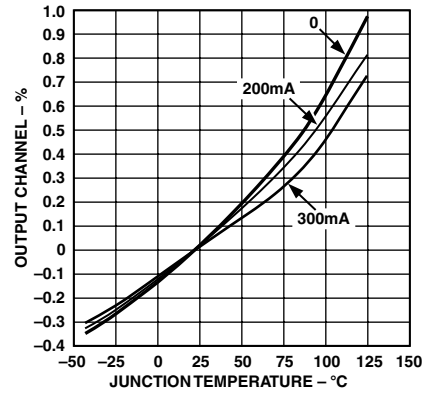

TPC 5. Output Voltage Variation vs. Junction Temperature

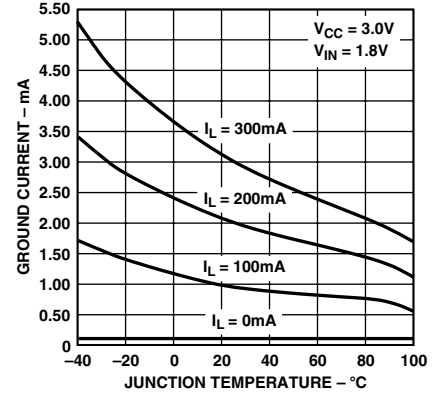

TPC 6. Ground Current vs. Junction Temperature

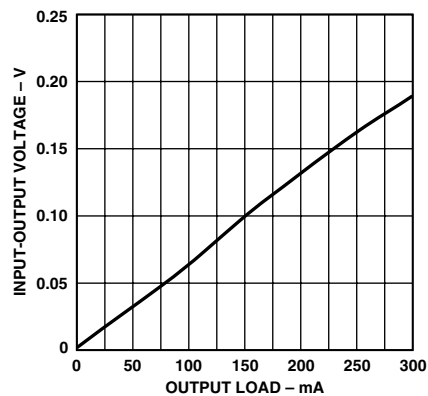

TPC 7. Dropout Voltage vs. Output Current

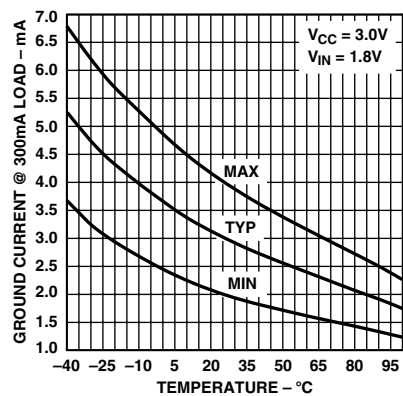

TPC 8. Ground Current @ 300mA Load vs. Ambient Temperature

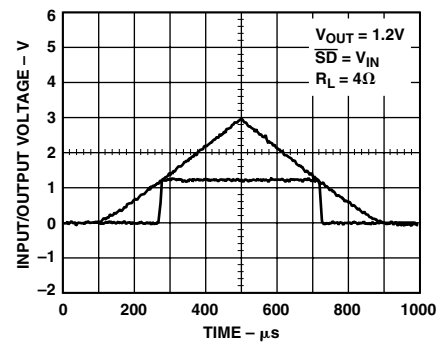

TPC 9. Power-Up/Power-Down

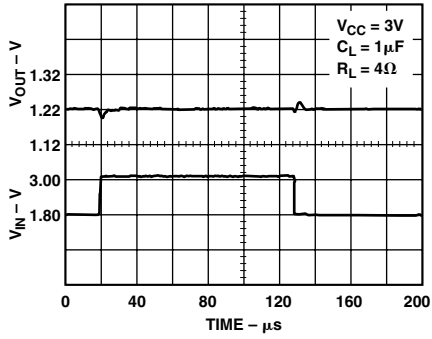

TPC 10. Line Transient Response

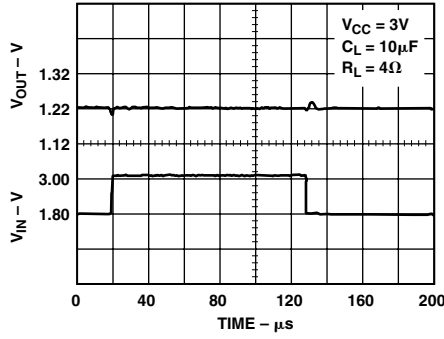

TPC 11. Line Transient Response

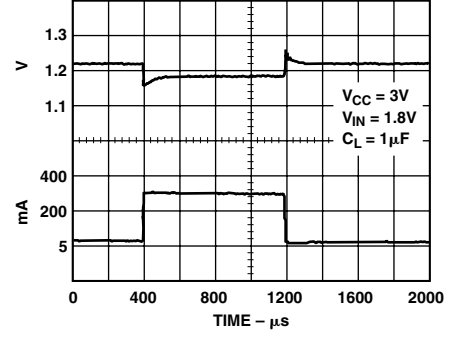

TPC 12. Load Transient Response

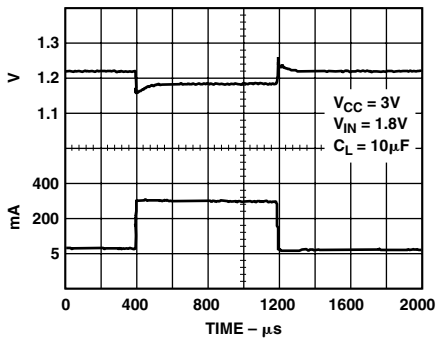

TPC 13. Load Transient Response

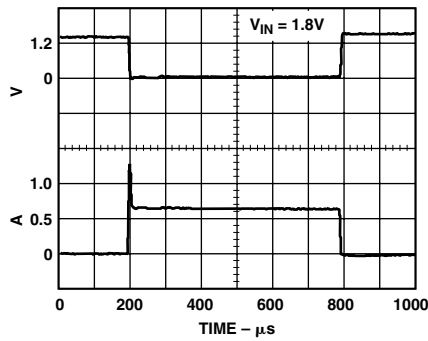

TPC 14. Short Circuit Current

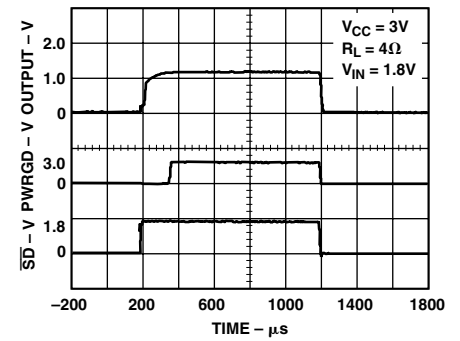

TPC 15. Power-On/Power-Off Response from Shutdown

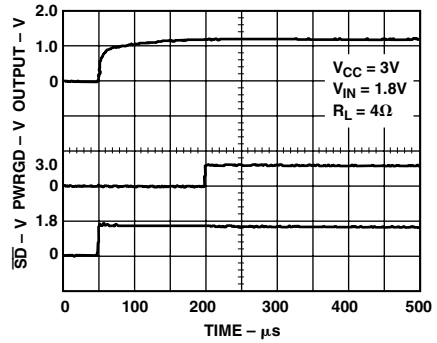

TPC 16. Turn On Delay

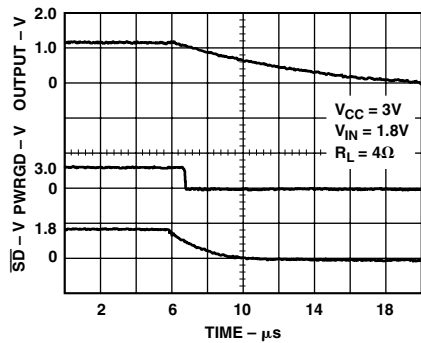

TPC 17. Turn Off Delay

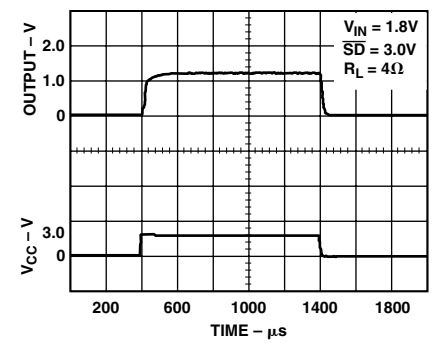

TPC 18. Power On/Power Off Response from V<sub>CC</sub>

# ADP3342

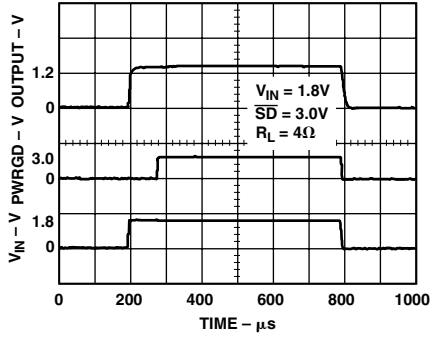

TPC 19. Power On/Power Off Response from  $V_{IN}$

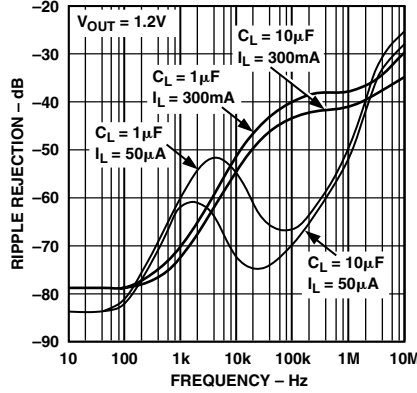

TPC 20. Power Supply Ripple Rejection

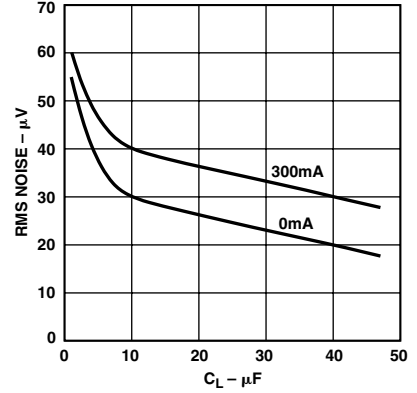

TPC 21. RMS Noise vs.  $C_L$  (10 Hz-100 Hz)

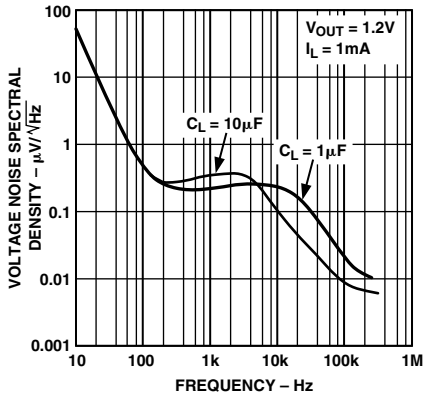

TPC 22. Output Noise Density

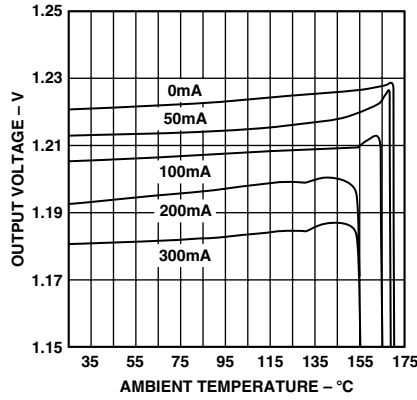

TPC 23. Thermal Protection

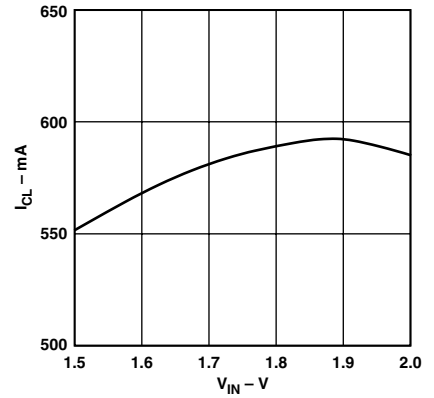

TPC 24. Current Limit vs.  $V_{IN}$

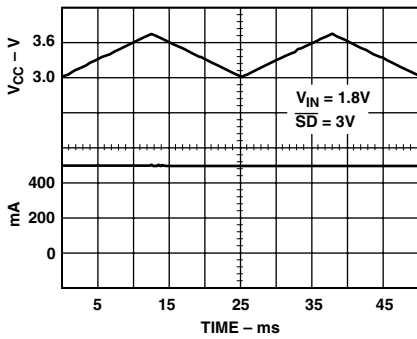

TPC 25. Current Limiting from  $V_{CC}$

## THEORY OF OPERATION

The new anyCAP LDO ADP3342 uses a single control loop for regulation and reference functions. The output voltage is sensed by a resistive voltage divider consisting of R1 and R2. Feedback is taken from this network by way of a series diode (D1) and a second resistor divider (R3 and R4) to the input of an amplifier.

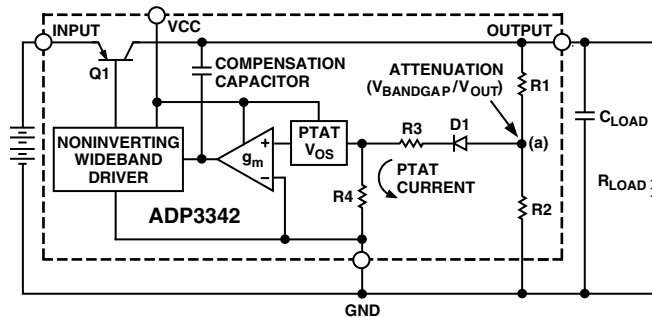

Figure 2. Control Loop Functional Block Diagram

A very high gain error amplifier is used to control this loop. The amplifier is constructed in such a way that at equilibrium it produces a large, temperature proportional input “offset voltage” that is repeatable and very well controlled. The temperature proportional offset voltage is combined with the complementary diode voltage to form a “virtual band gap” voltage, implicit in the network, although it never appears explicitly in the circuit. Ultimately, this patented design makes it possible to control the loop with only one amplifier. This technique also improves the noise characteristics of the amplifier by providing more flexibility on the trade-off of noise sources that lead to a low noise design.

The R1, R2 divider is chosen in the same ratio as the band gap voltage to the output voltage. Although the R1, R2 resistor divider is loaded by the diode D1 and a second divider consisting of R3 and R4, the values can be chosen to produce a temperature stable output. This unique arrangement specifically corrects for the loading of the divider so that the error resulting from base current loading in conventional circuits is avoided.

The patented amplifier controls a new and unique noninverting driver that drives the pass transistor, Q1. The use of this special noninverting driver enables the frequency compensation to include the load capacitor in a pole splitting arrangement to achieve reduced sensitivity to the value, type, and ESR of the load capacitance.

Most LDOs place very strict requirements on the range of ESR values for the output capacitor because they are difficult to stabilize due to the uncertainty of load capacitance and resistance. Moreover, the ESR value, required to keep conventional LDOs stable, changes depending on load and temperature. These ESR limitations make designing with LDOs more difficult because of their unclear specifications and extreme variations over temperature.

With the ADP3342 anyCAP LDO, this is no longer true. It can be used with virtually any good quality capacitor, with no constraint on the minimum ESR. This innovative design allows the circuit to be stable with just a small 1  $\mu\text{F}$  capacitor on the output. Additional advantages of the pole splitting scheme include superior line noise rejection and very high regulator gain, which leads to excellent line and load regulation.

Additional features of the circuit include current limit and thermal shutdown and noise reduction.

## APPLICATION INFORMATION

### PC Application—VCCVID

The ADP3342 has been optimized for PC applications that require a 1.2 V output for powering the voltage identification rail, VCCVID. The rail from which the output draws current, the IN pin, is separated from the rail that powers the IC, the VCC pin. This allows a higher efficiency design when, as recommended for the IMVP-3 application, the VCC pin is connected to a 3.3 V supply to power the IC adequately, and the IN pin is connected to a 1.8 V supply. The efficiency is nearly 60% in this case.

### Capacitor Selection

As with any voltage regulator, output transient response is a function of the output capacitance. The ADP3342 is stable with a wide range of capacitor values, types, and ESR (anyCAP). A capacitor as low as 1  $\mu\text{F}$  is all that is needed for stability; larger capacitors can be used if high output current surges are anticipated. The ADP3342 is stable with extremely low ESR capacitors ( $\text{ESR} \approx 0$ ), such as multilayer ceramic capacitors (MLCC) or OSCON. Note that the effective capacitance of some capacitor types may fall below the minimum at cold temperature. Ensure that the capacitor provides more than 1  $\mu\text{F}$  at minimum temperature.

### Input Bypass Capacitor

An input bypass capacitor is not strictly required but is advisable in any application involving long input wires or high source impedance. Connecting a 1  $\mu\text{F}$  capacitor from IN to ground reduces the circuit’s sensitivity to PC board layout. If a larger value output capacitor is used, then a larger value input capacitor is also recommended.

### Power Good Monitoring Function

The PWRGD pin does not monitor the output voltage directly but rather detects whether the internal PNP pass transistor is being modulated by the regulation loop. This means of detecting PWRGD, rather than using a voltage threshold detection, provides an inherent and desirable delay in asserting the PWRGD signal. During startup or overload, the regulation loop is not in control, so the PWRGD pin is low.

### Shutdown Mode

Applying a TTL high signal to the shutdown ( $\overline{\text{SD}}$ ) pin, or tying it to the input pin, will turn the output ON. Pulling  $\overline{\text{SD}}$  down to 0.4 V or below, or tying it to ground, will turn the output OFF. In shutdown mode, quiescent current is reduced.

### Paddle-Under-Lead Package

The ADP3342 uses a patented paddle-under-lead package design to ensure the best thermal performance in an MSOP-8 footprint. This new package uses an electrically isolated die attach that allows all pins to contribute to heat conduction. This technique reduces the thermal resistance to 110°C/W on a 4-layer board as compared to >160°C/W for a standard MSOP-8 leadframe.

### Thermal Overload Protection

The ADP3342 is protected against damage due to excessive power dissipation by its thermal overload protection circuit, which limits the die temperature to a maximum of 165°C. Under extreme conditions (i.e., high ambient temperature and power dissipation) where die temperature starts to rise above 165°C, the output current is reduced until the die temperature has dropped

# ADP3342

to a safe level. The output current is restored when the die temperature is reduced.

Current and thermal limit protections are intended to protect the device against accidental overload conditions. For normal operation, device power dissipation should be limited by operating conditions so that junction temperatures will not exceed 150°C.

## Calculating Junction Temperature

Device power dissipation is calculated as follows:

$$P_D = (V_{IN} - V_{OUT}) I_{LOAD} + (V_{IN}) I_{GND}$$

Where  $I_{LOAD}$  and  $I_{GND}$  are load current and ground current, and  $V_{IN}$  and  $V_{OUT}$  are input and output voltages, respectively.

Assuming  $I_{LOAD} = 300 \text{ mA}$ ,  $I_{GND} = 4 \text{ mA}$ ,  $V_{IN} = 1.8 \text{ V}$ , and  $V_{OUT} = 1.2 \text{ V}$ , device power dissipation is:

$$P_D = (1.8 - 1.2) 300 \text{ mA} + (1.8) 4 \text{ mA} = 187 \text{ mW}$$

The proprietary package used in the ADP3342 has a thermal resistance of 110°C/W, significantly lower than a standard MSOP-8 package. Assuming a 4-layer board, the junction temperature rise above ambient temperature will be approximately equal to:

$$\Delta T_{JA} = 0.187 \text{ W} \times 110^\circ\text{C/W} = 20.6^\circ\text{C}$$

## OUTLINE DIMENSIONS

### 8-Lead MSOP Package [MSOP] (RM-8)

Dimensions shown in millimeters

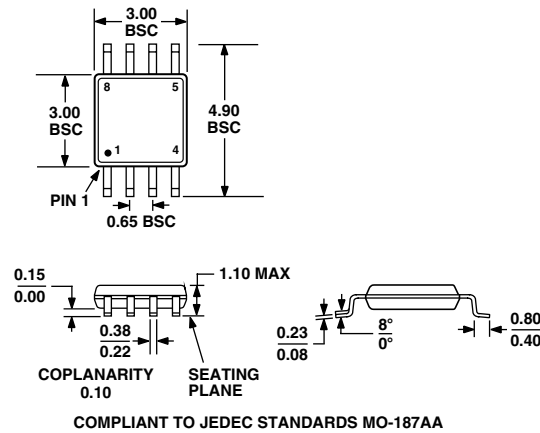

## Revision History

Location	Page
10/02—Data Sheet changed from REV. 0 to REV. A.	
Changes to PIN CONFIGURATION .....	3
Changes to PIN FUNCTION DESCRIPTION .....	3
OUTLINE DIMENSIONS Updated .....	8