

Low-Voltage CMOS Octal Buffer Flow Through Pinout With 5V-Tolerant Inputs and Outputs (3-State, Inverting)

The MC74LCX540 is a high performance, inverting octal buffer operating from a 2.3 to 3.6V supply. This device is similar in function to the MC74LCX240, while providing flow through architecture. High impedance TTL compatible inputs significantly reduce current loading to input drivers while TTL compatible outputs offer improved switching noise performance. A V_I specification of 5.5V allows MC74LCX540 inputs to be safely driven from 5V devices. The MC74LCX540 is suitable for memory address driving and all TTL level bus oriented transceiver applications.

Current drive capability is 24mA at the outputs. The Output Enable ($\overline{OE1}$, $\overline{OE2}$) inputs, when HIGH, disables the outputs by placing them in a HIGH Z condition.

- Designed for 2.3 to 3.6V V_{CC} Operation
- 5V Tolerant — Interface Capability With 5V TTL Logic
- Supports Live Insertion and Withdrawal
- I_{OFF} Specification Guarantees High Impedance When $V_{CC} = 0V$
- LVTTTL Compatible
- LVC MOS Compatible
- 24mA Balanced Output Sink and Source Capability
- Near Zero Static Supply Current in All Three Logic States (10 μ A)
Substantially Reduces System Power Requirements
- Latchup Performance Exceeds 500mA
- ESD Performance: Human Body Model >2000V; Machine Model >200V

MC74LCX540

LCX

LOW-VOLTAGE CMOS OCTAL BUFFER

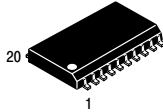

20
1

DW SUFFIX
PLASTIC SOIC
CASE 751D-04

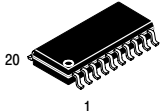

20
1

M SUFFIX
PLASTIC SOIC EIAJ
CASE 967-01

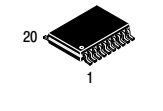

20
1

DT SUFFIX
PLASTIC TSSOP
CASE 948E-02

PIN NAMES

| Pins | Function |
|------------------|----------------------|
| $\overline{OE1}$ | Output Enable Inputs |
| Dn | Data Inputs |
| $\overline{O1}$ | 3-State Outputs |

MC74LCX540

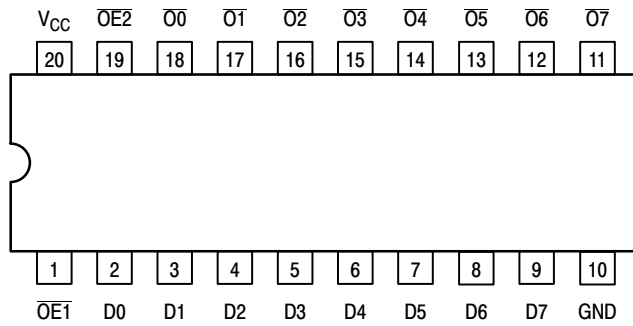

Figure 1. Pinout: 20-Lead (Top View)

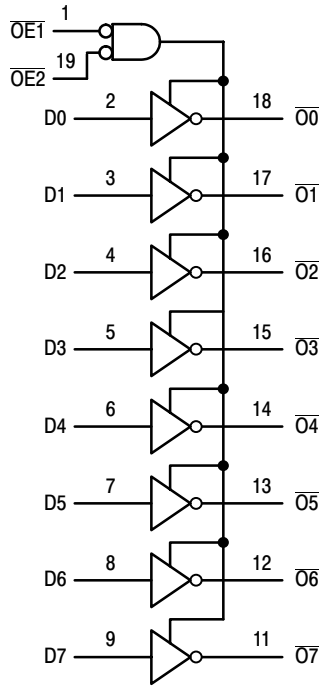

Figure 2. LOGIC DIAGRAM

| INPUTS | | | OUTPUTS |
|-----------------|-----------------|----------------|----------------|
| OE ₁ | OE ₂ | D _n | O _n |
| L | L | L | H |
| L | L | H | L |
| X | H | X | Z |
| H | X | X | Z |

H = High Voltage Level; L = Low Voltage Level; Z = High Impedance State; X = High or Low Voltage Level and Transitions Are Acceptable, for I_{CC} reasons, DO NOT FLOAT Inputs

MC74LCX540

ABSOLUTE MAXIMUM RATINGS*

| Symbol | Parameter | Value | Condition | Unit |
|------------------|----------------------------------|---|----------------------------------|------|
| V _{CC} | DC Supply Voltage | -0.5 to +7.0 | | V |
| V _I | DC Input Voltage | -0.5 ≤ V _I ≤ +7.0 | | V |
| V _O | DC Output Voltage | -0.5 ≤ V _O ≤ +7.0 | Output in 3-State | V |
| | | -0.5 ≤ V _O ≤ V _{CC} + 0.5 | Note 1. | V |
| I _{IK} | DC Input Diode Current | -50 | V _I < GND | mA |
| I _{OK} | DC Output Diode Current | -50 | V _O < GND | mA |
| | | +50 | V _O > V _{CC} | mA |
| I _O | DC Output Source/Sink Current | ±50 | | mA |
| I _{CC} | DC Supply Current Per Supply Pin | ±100 | | mA |
| I _{GND} | DC Ground Current Per Ground Pin | ±100 | | mA |
| T _{STG} | Storage Temperature Range | -65 to +150 | | °C |

* Absolute maximum continuous ratings are those values beyond which damage to the device may occur. Exposure to these conditions or conditions beyond those indicated may adversely affect device reliability. Functional operation under absolute-maximum-rated conditions is not implied.

1. Output in HIGH or LOW State. I_O absolute maximum rating must be observed.

RECOMMENDED OPERATING CONDITIONS

| Symbol | Parameter | Min | Typ | Max | Unit | |
|-----------------|---|---------------------|-----|-----------------|------|---|
| V _{CC} | Supply Voltage | Operating | 2.0 | 3.3 | 3.6 | V |
| | | Data Retention Only | 1.5 | 3.3 | 3.6 | |
| V _I | Input Voltage | 0 | | 5.5 | V | |
| V _O | Output Voltage (HIGH or LOW State) (3-State) | 0 | | V _{CC} | V | |
| | | 0 | | 5.5 | | |
| I _{OH} | HIGH Level Output Current, V _{CC} = 3.0V – 3.6V | | | -24 | mA | |
| I _{OL} | LOW Level Output Current, V _{CC} = 3.0V – 3.6V | | | 24 | mA | |
| I _{OH} | HIGH Level Output Current, V _{CC} = 2.7V – 3.0V | | | -12 | mA | |
| I _{OL} | LOW Level Output Current, V _{CC} = 2.7V – 3.0V | | | 12 | mA | |
| T _A | Operating Free-Air Temperature | -40 | | +85 | °C | |
| Δt/ΔV | Input Transition Rise or Fall Rate, V _{IN} from 0.8V to 2.0V, V _{CC} = 3.0V | 0 | | 10 | ns/V | |

DC ELECTRICAL CHARACTERISTICS

| Symbol | Characteristic | Condition | T _A = -40°C to +85°C | | Unit |
|-----------------|------------------------------------|---|---------------------------------|------|------|
| | | | Min | Max | |
| V _{IH} | HIGH Level Input Voltage (Note 2.) | 2.7V ≤ V _{CC} ≤ 3.6V | 2.0 | | V |
| V _{IL} | LOW Level Input Voltage (Note 2.) | 2.7V ≤ V _{CC} ≤ 3.6V | | 0.8 | V |
| V _{OH} | HIGH Level Output Voltage | 2.7V ≤ V _{CC} ≤ 3.6V; I _{OH} = -100μA | V _{CC} - 0.2 | | V |
| | | V _{CC} = 2.7V; I _{OH} = -12mA | 2.2 | | |
| | | V _{CC} = 3.0V; I _{OH} = -18mA | 2.4 | | |
| | | V _{CC} = 3.0V; I _{OH} = -24mA | 2.2 | | |
| V _{OL} | LOW Level Output Voltage | 2.7V ≤ V _{CC} ≤ 3.6V; I _{OL} = 100μA | | 0.2 | V |
| | | V _{CC} = 2.7V; I _{OL} = 12mA | | 0.4 | |
| | | V _{CC} = 3.0V; I _{OL} = 16mA | | 0.4 | |
| | | V _{CC} = 3.0V; I _{OL} = 24mA | | 0.55 | |

2. These values of V_I are used to test DC electrical characteristics only.

MC74LCX540

DC ELECTRICAL CHARACTERISTICS (continued)

| Symbol | Characteristic | Condition | T _A = -40°C to +85°C | | Unit |
|------------------|---------------------------------------|--|---------------------------------|------|------|
| | | | Min | Max | |
| I _I | Input Leakage Current | 2.7V ≤ V _{CC} ≤ 3.6V; 0V ≤ V _I ≤ 5.5V | | ±5.0 | μA |
| I _{OZ} | 3-State Output Current | 2.7 ≤ V _{CC} ≤ 3.6V; 0V ≤ V _O ≤ 5.5V; V _I = V _{IH} or V _{IL} | | ±5.0 | μA |
| I _{OFF} | Power-Off Leakage Current | V _{CC} = 0V; V _I or V _O = 5.5V | | 10 | μA |
| I _{CC} | Quiescent Supply Current | 2.7 ≤ V _{CC} ≤ 3.6V; V _I = GND or V _{CC} | | 10 | μA |
| | | 2.7 ≤ V _{CC} ≤ 3.6V; 3.6 ≤ V _I or V _O ≤ 5.5V | | ±10 | μA |
| ΔI _{CC} | Increase in I _{CC} per Input | 2.7 ≤ V _{CC} ≤ 3.6V; V _{IH} = V _{CC} - 0.6V | | 500 | μA |

AC CHARACTERISTICS (t_R = t_F = 2.5ns; C_L = 50pF; R_L = 500Ω)

| Symbol | Parameter | Waveform | Limits | | | Unit |
|--|--|----------|---------------------------------|------------|------------------------|------|
| | | | T _A = -40°C to +85°C | | | |
| | | | V _{CC} = 3.0V to 3.6V | | V _{CC} = 2.7V | |
| | | | Min | Max | Max | |
| t _{PLH} t _{PHL} | Propagation Delay Input to Output | 1 | 1.5 1.5 | 6.5 6.5 | 7.5 7.5 | ns |
| t _{PZH} t _{PZL} | Output Enable Time to High and Low Level | 2 | 1.5 1.5 | 8.5 8.5 | 9.5 9.5 | ns |
| t _{PHZ} t _{PLZ} | Output Disable Time From High and Low Level | 2 | 1.5 1.5 | 7.5 7.5 | 8.5 8.5 | ns |
| t _{OSSL} t _{OSLH} | Output-to-Output Skew (Note 3.) | | | 1.0 1.0 | | ns |

3. Skew is defined as the absolute value of the difference between the actual propagation delay for any two separate outputs of the same device. The specification applies to any outputs switching in the same direction, either HIGH-to-LOW (t_{OSSL}) or LOW-to-HIGH (t_{OSLH}); parameter guaranteed by design.

DYNAMIC SWITCHING CHARACTERISTICS

| Symbol | Characteristic | Condition | T _A = +25°C | | | Unit |
|------------------|--------------------------------------|---|------------------------|-----|-----|------|
| | | | Min | Typ | Max | |
| V _{OLP} | Dynamic LOW Peak Voltage (Note 4.) | V _{CC} = 3.3V, C _L = 50pF, V _{IH} = 3.3V, V _{IL} = 0V | | 0.8 | | V |
| V _{OLV} | Dynamic LOW Valley Voltage (Note 4.) | V _{CC} = 3.3V, C _L = 50pF, V _{IH} = 3.3V, V _{IL} = 0V | | 0.8 | | V |

4. Number of outputs defined as "n". Measured with "n-1" outputs switching from HIGH-to-LOW or LOW-to-HIGH. The remaining output is measured in the LOW state.

CAPACITIVE CHARACTERISTICS

| Symbol | Parameter | Condition | Typical | Unit |
|------------------|-------------------------------|---|---------|------|
| C _{IN} | Input Capacitance | V _{CC} = 3.3V, V _I = 0V or V _{CC} | 7 | pF |
| C _{OUT} | Output Capacitance | V _{CC} = 3.3V, V _I = 0V or V _{CC} | 8 | pF |
| C _{PD} | Power Dissipation Capacitance | 10MHz, V _{CC} = 3.3V, V _I = 0V or V _{CC} | 25 | pF |

MC74LCX540

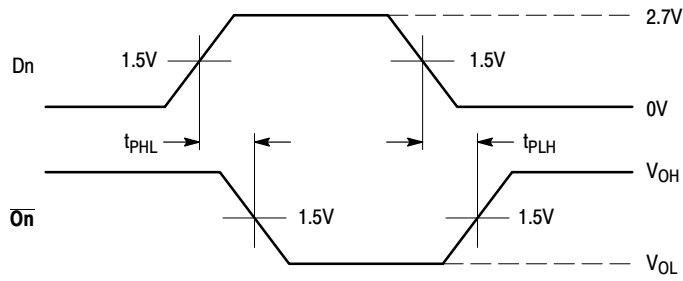

WAVEFORM 1 - PROPAGATION DELAYS
 $t_R = t_F = 2.5\text{ns}$, 10% to 90%; $f = 1\text{MHz}$; $t_W = 500\text{ns}$

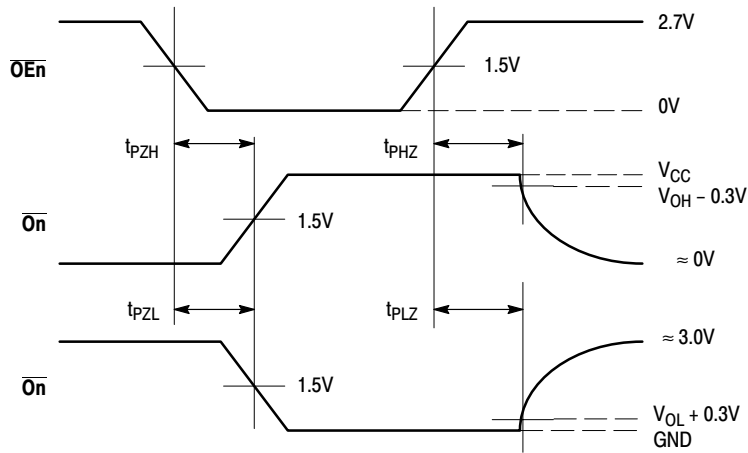

WAVEFORM 2 - OUTPUT ENABLE AND DISABLE TIMES
 $t_R = t_F = 2.5\text{ns}$, 10% to 90%; $f = 1\text{MHz}$; $t_W = 500\text{ns}$

Figure 3. AC Waveforms

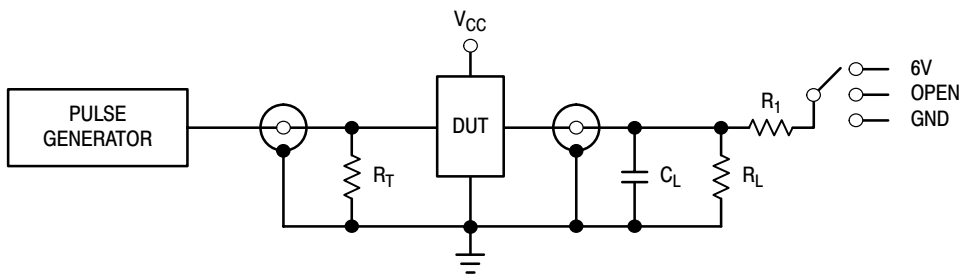

| TEST | SWITCH |
|--|--------|
| t_{PLH} , t_{PHL} | Open |
| t_{PZL} , t_{PLZ} | 6V |
| Open Collector/Drain t_{PLH} and t_{PHL} | 6V |
| t_{PZH} , t_{PHZ} | GND |

$C_L = 50\text{pF}$ or equivalent (Includes jig and probe capacitance)
 $R_L = R_1 = 500\Omega$ or equivalent
 $R_T = Z_{OUT}$ of pulse generator (typically 50Ω)

Figure 4. Test Circuit

MC74LCX540

OUTLINE DIMENSIONS

DW SUFFIX PLASTIC SOIC PACKAGE CASE 751D-04 ISSUE E

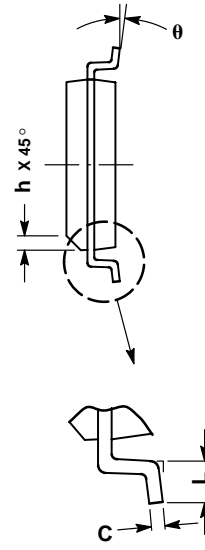
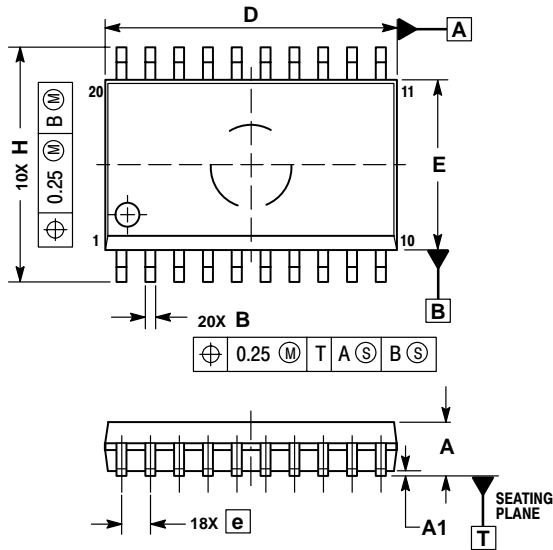

NOTES:

- DIMENSIONS ARE IN MILLIMETERS.
- INTERPRET DIMENSIONS AND TOLERANCES PER ASME Y14.5M, 1994.
- DIMENSIONS D AND E DO NOT INCLUDE MOLD PROTRUSION.
- MAXIMUM MOLD PROTRUSION 0.15 PER SIDE.
- DIMENSION B DOES NOT INCLUDE DAMBAR PROTRUSION. ALLOWABLE PROTRUSION SHALL BE 0.13 TOTAL IN EXCESS OF B DIMENSION AT MAXIMUM MATERIAL CONDITION.

| DIM | MILLIMETERS | |
|-------|-------------|-------|
| | MIN | MAX |
| A | 2.35 | 2.65 |
| A1 | 0.10 | 0.25 |
| B | 0.35 | 0.49 |
| C | 0.23 | 0.32 |
| D | 12.65 | 12.95 |
| E | 7.40 | 7.60 |
| e | 1.27 BSC | |
| H | 10.05 | 10.55 |
| h | 0.25 | 0.75 |
| L | 0.50 | 0.90 |
| theta | 0° | 7° |

M SUFFIX PLASTIC SOIC EIAJ PACKAGE CASE 967-01 ISSUE O

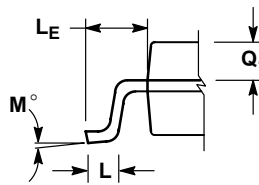
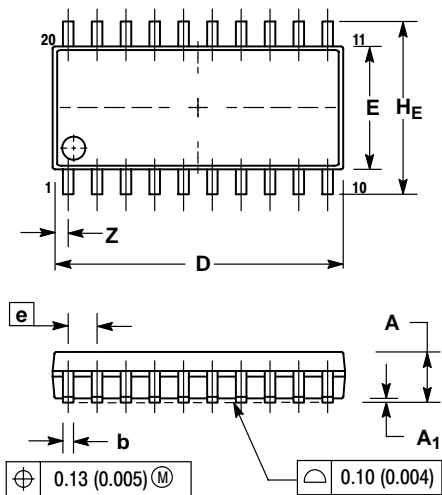

DETAIL P

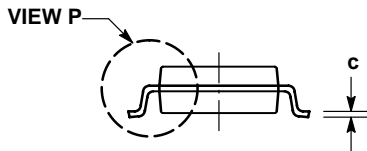

NOTES:

- DIMENSIONING AND TOLERANCING PER ANSI Y14.5M, 1982.
- CONTROLLING DIMENSION: MILLIMETER.
- DIMENSIONS D AND E DO NOT INCLUDE MOLD FLASH OR PROTRUSIONS AND ARE MEASURED AT THE PARTING LINE. MOLD FLASH OR PROTRUSIONS SHALL NOT EXCEED 0.15 (0.006) PER SIDE.
- TERMINAL NUMBERS ARE SHOWN FOR REFERENCE ONLY.
- THE LEAD WIDTH DIMENSION (b) DOES NOT INCLUDE DAMBAR PROTRUSION. ALLOWABLE DAMBAR PROTRUSION SHALL BE 0.08 (0.003) TOTAL IN EXCESS OF THE LEAD WIDTH DIMENSION AT MAXIMUM MATERIAL CONDITION. DAMBAR CANNOT BE LOCATED ON THE LOWER RADIUS OR THE FOOT. MINIMUM SPACE BETWEEN PROTRUSIONS AND ADJACENT LEAD TO BE 0.46 (0.018).

| DIM | MILLIMETERS | | INCHES | |
|-----|-------------|-------|-----------|-------|
| | MIN | MAX | MIN | MAX |
| A | --- | 2.05 | --- | 0.081 |
| A1 | 0.05 | 0.20 | 0.002 | 0.008 |
| b | 0.35 | 0.50 | 0.014 | 0.020 |
| c | 0.18 | 0.27 | 0.007 | 0.011 |
| D | 12.35 | 12.80 | 0.486 | 0.504 |
| E | 5.10 | 5.45 | 0.201 | 0.215 |
| e | 1.27 BSC | | 0.050 BSC | |
| H_E | 7.40 | 8.20 | 0.291 | 0.323 |
| L | 0.50 | 0.85 | 0.020 | 0.033 |
| L_E | 1.10 | 1.50 | 0.043 | 0.059 |
| M | 0° | 10° | 0° | 10° |
| Q_1 | 0.70 | 0.90 | 0.028 | 0.035 |
| Z | --- | 0.81 | --- | 0.032 |

MC74LCX540

OUTLINE DIMENSIONS

DT SUFFIX
 PLASTIC TSSOP PACKAGE
 CASE 948E-02
 ISSUE A

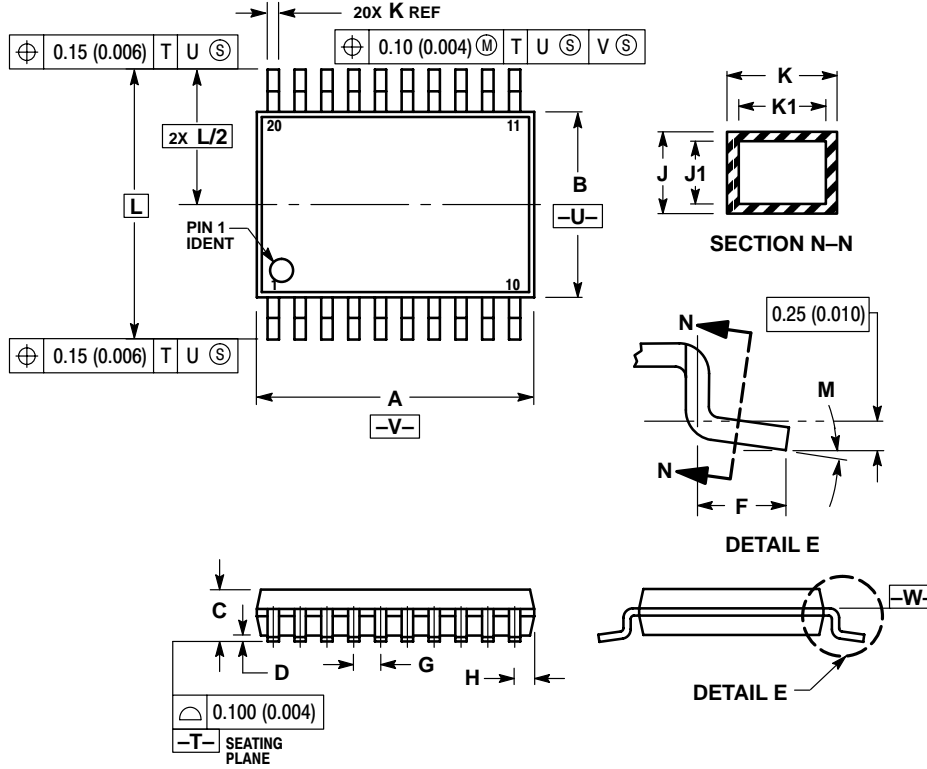

NOTES:

1. DIMENSIONING AND TOLERANCING PER ANSI Y14.5M, 1982.
2. CONTROLLING DIMENSION: MILLIMETER.
3. DIMENSION A DOES NOT INCLUDE MOLD FLASH, PROTRUSIONS OR GATE BURRS. MOLD FLASH OR GATE BURRS SHALL NOT EXCEED 0.15 (0.006) PER SIDE.
4. DIMENSION B DOES NOT INCLUDE INTERLEAD FLASH OR PROTRUSION. INTERLEAD FLASH OR PROTRUSION SHALL NOT EXCEED 0.25 (0.010) PER SIDE.
5. DIMENSION K DOES NOT INCLUDE DAMBAR PROTRUSION. ALLOWABLE DAMBAR PROTRUSION SHALL BE 0.08 (0.003) TOTAL IN EXCESS OF THE K DIMENSION AT MAXIMUM MATERIAL CONDITION.
6. TERMINAL NUMBERS ARE SHOWN FOR REFERENCE ONLY.
7. DIMENSION A AND B ARE TO BE DETERMINED AT DATUM PLANE -W-.

| DIM | MILLIMETERS | | INCHES | |
|-----|-------------|------|-----------|-------|
| | MIN | MAX | MIN | MAX |
| A | 6.40 | 6.60 | 0.252 | 0.260 |
| B | 4.30 | 4.50 | 0.169 | 0.177 |
| C | --- | 1.20 | --- | 0.047 |
| D | 0.05 | 0.15 | 0.002 | 0.006 |
| F | 0.50 | 0.75 | 0.020 | 0.030 |
| G | 0.65 BSC | | 0.026 BSC | |
| H | 0.27 | 0.37 | 0.011 | 0.015 |
| J | 0.09 | 0.20 | 0.004 | 0.008 |
| J1 | 0.09 | 0.16 | 0.004 | 0.006 |
| K | 0.19 | 0.30 | 0.007 | 0.012 |
| K1 | 0.19 | 0.25 | 0.007 | 0.010 |
| L | 6.40 BSC | | 0.252 BSC | |
| M | 0° | 8° | 0° | 8° |

ON Semiconductor and  are trademarks of Semiconductor Components Industries, LLC (SCILLC). SCILLC reserves the right to make changes without further notice to any products herein. SCILLC makes no warranty, representation or guarantee regarding the suitability of its products for any particular purpose, nor does SCILLC assume any liability arising out of the application or use of any product or circuit, and specifically disclaims any and all liability, including without limitation special, consequential or incidental damages. "Typical" parameters which may be provided in SCILLC data sheets and/or specifications can and do vary in different applications and actual performance may vary over time. All operating parameters, including "Typicals" must be validated for each customer application by customer's technical experts. SCILLC does not convey any license under its patent rights nor the rights of others. SCILLC products are not designed, intended, or authorized for use as components in systems intended for surgical implant into the body, or other applications intended to support or sustain life, or for any other application in which the failure of the SCILLC product could create a situation where personal injury or death may occur. Should Buyer purchase or use SCILLC products for any such unintended or unauthorized application, Buyer shall indemnify and hold SCILLC and its officers, employees, subsidiaries, affiliates, and distributors harmless against all claims, costs, damages, and expenses, and reasonable attorney fees arising out of, directly or indirectly, any claim of personal injury or death associated with such unintended or unauthorized use, even if such claim alleges that SCILLC was negligent regarding the design or manufacture of the part. SCILLC is an Equal Opportunity/Affirmative Action Employer.

PUBLICATION ORDERING INFORMATION

NORTH AMERICA Literature Fulfillment:

Literature Distribution Center for ON Semiconductor
P.O. Box 5163, Denver, Colorado 80217 USA
Phone: 303-675-2175 or 800-344-3860 Toll Free USA/Canada
Fax: 303-675-2176 or 800-344-3867 Toll Free USA/Canada
Email: ONlit@hibbertco.com
Fax Response Line: 303-675-2167 or 800-344-3810 Toll Free USA/Canada

N. American Technical Support: 800-282-9855 Toll Free USA/Canada

EUROPE: LDC for ON Semiconductor – European Support

German Phone: (+1) 303-308-7140 (Mon-Fri 2:30pm to 7:00pm CET)
Email: ONlit-german@hibbertco.com
French Phone: (+1) 303-308-7141 (Mon-Fri 2:00pm to 7:00pm CET)
Email: ONlit-french@hibbertco.com
English Phone: (+1) 303-308-7142 (Mon-Fri 12:00pm to 5:00pm GMT)
Email: ONlit@hibbertco.com

EUROPEAN TOLL-FREE ACCESS*: 00-800-4422-3781

*Available from Germany, France, Italy, UK, Ireland

CENTRAL/SOUTH AMERICA:

Spanish Phone: 303-308-7143 (Mon-Fri 8:00am to 5:00pm MST)
Email: ONlit-spanish@hibbertco.com
Toll-Free from Mexico: Dial 01-800-288-2872 for Access –
then Dial 866-297-9322

ASIA/PACIFIC: LDC for ON Semiconductor – Asia Support

Phone: 303-675-2121 (Tue-Fri 9:00am to 1:00pm, Hong Kong Time)
Toll Free from Hong Kong & Singapore:
001-800-4422-3781
Email: ONlit-asia@hibbertco.com

JAPAN: ON Semiconductor, Japan Customer Focus Center
4-32-1 Nishi-Gotanda, Shinagawa-ku, Tokyo, Japan 141-0031
Phone: 81-3-5740-2700
Email: r14525@onsemi.com

ON Semiconductor Website: <http://onsemi.com>

For additional information, please contact your local Sales Representative.