



MUR1620CT  
MURB1620CT  
MURB1620CT-1

Ultrafast Rectifier

Features

- Ultrafast Recovery Time
- Low Forward Voltage Drop
- Low Leakage Current
- 175°C Operating Junction Temperature

$t_{rr} = 25ns$   
 $I_{F(AV)} = 16Amp$   
 $V_R = 200V$

Description/Applications

International Rectifier's MUR.. series are the state of the art Ultra fast recovery rectifiers specifically designed with optimized performance of forward voltage drop and ultra fast recovery time.

The planar structure and the platinum doped life time control, guarantee the best overall performance, ruggedness and reliability characteristics.

These devices are intended for use in the output rectification stage of SMPS, UPS, DC-DC converters as well as free-wheeling diode in low voltage inverters and chopper motor drives.

Their extremely optimized stored charge and low recovery current minimize the switching losses and reduce over dissipation in the switching element and snubbers.

Absolute Maximum Ratings

Parameters		Max	Units
$V_{RRM}$	Peak Repetitive Peak Reverse Voltage	200	V
$I_{F(AV)}$	Average Rectified Forward Current Per Leg	8.0	A
	Total Device, (Rated $V_R$ ), $T_C = 150^\circ C$ Total Device	16	
$I_{FSM}$	Non Repetitive Peak Surge Current Per Leg	100	
$I_{FM}$	Peak Repetitive Forward Current Per Leg (Rated $V_R$ , Square wave, 20 KHz), $T_C = 150^\circ C$	16	
$T_J, T_{STG}$	Operating Junction and Storage Temperatures	-65 to 175	$^\circ C$

Case Styles		
<p>MUR1620CT</p>  <p>TO-220AB</p>	<p>MURB1620CT</p>  <p>D<sup>2</sup>PAK</p>	<p>MURB1620CT-1</p>  <p>TO-262</p>

**Electrical Characteristics @ T<sub>J</sub> = 25°C (unless otherwise specified)**

Parameters	Min	Typ	Max	Units	Test Conditions
V <sub>BR</sub> , V <sub>F</sub> Breakdown Voltage, Blocking Voltage	200	-	-	V	I <sub>R</sub> = 100μA
V <sub>F</sub> Forward Voltage	-	-	0.975	V	I <sub>F</sub> = 8A
	-	-	0.895	V	I <sub>F</sub> = 8A, T <sub>J</sub> = 150°C
I <sub>R</sub> Reverse Leakage Current	-	-	5	μA	V <sub>R</sub> = V <sub>R</sub> Rated
	-	-	250	μA	T <sub>J</sub> = 150°C, V <sub>R</sub> = V <sub>R</sub> Rated
C <sub>T</sub> Junction Capacitance	-	25	-	pF	V <sub>R</sub> = 200V
L <sub>S</sub> Series Inductance	-	8.0	-	nH	Measured lead to lead 5mm from package body

**Dynamic Recovery Characteristics @ T<sub>J</sub> = 25°C (unless otherwise specified)**

Parameters	Min	Typ	Max	Units	Test Conditions	
t <sub>rr</sub> Reverse Recovery Time	-	-	35	ns	I <sub>F</sub> = 1.0A, di <sub>F</sub> /dt = 50A/μs, V <sub>R</sub> = 30V	
	-	-	25		I <sub>F</sub> = 0.5A, I <sub>R</sub> = 1.0A, I <sub>REC</sub> = 0.25A	
	-	20	-	A	T <sub>J</sub> = 25°C	
	-	34	-		T <sub>J</sub> = 125°C	
I <sub>RRM</sub> Peak Recovery Current	-	1.7	-	T <sub>J</sub> = 25°C	I <sub>F</sub> = 8A V <sub>R</sub> = 160V di <sub>F</sub> /dt = 200A/μs	
	-	4.2	-	T <sub>J</sub> = 125°C		
Q <sub>rr</sub> Reverse Recovery Charge	-	23	-	nC		T <sub>J</sub> = 25°C
	-	75	-	nC		T <sub>J</sub> = 125°C

**Thermal - Mechanical Characteristics**

Parameters	Min	Typ	Max	Units
T <sub>J</sub> Max. Junction Temperature Range	-	-	- 65 to 175	°C
T <sub>Stg</sub> Max. Storage Temperature Range	-	-	- 65 to 175	
R <sub>thJC</sub> Thermal Resistance, Junction to Case Per Leg	-	-	3.0	°C/W
R <sub>thJA</sub> Thermal Resistance, Junction to Ambient Per Leg	-	-	50	
R <sub>thCS</sub> <sup>①</sup> Thermal Resistance, Case to Heatsink	-	0.5	-	
Wt Weight	-	2.0	-	g
	-	0.07	-	(oz)
Mounting Torque	6.0	-	12	Kg-cm
	5.0	-	10	lbf.in

① Mounting Surface, Flat, Smooth and Greased

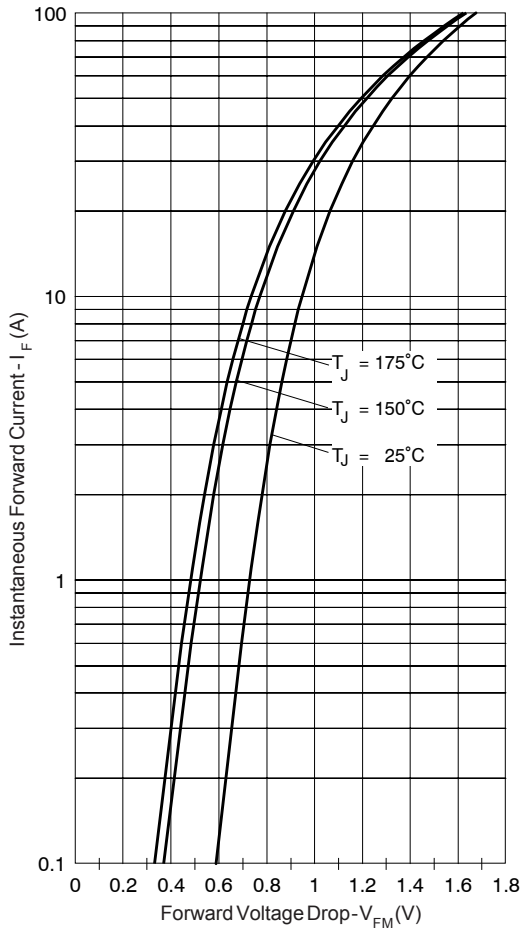

Fig. 1 - Typical Forward Voltage Drop Characteristics

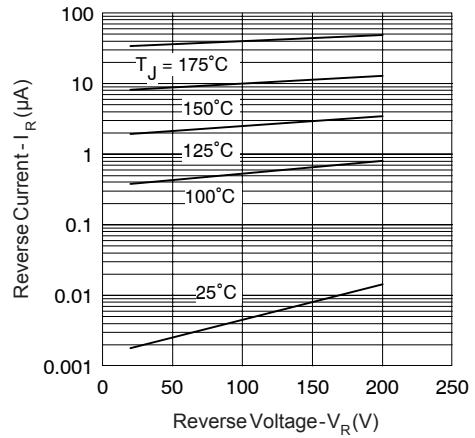

Fig. 2 - Typical Values Of Reverse Current Vs. Reverse Voltage

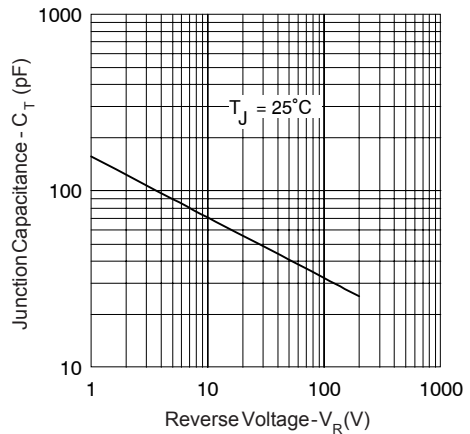

Fig. 3 - Typical Junction Capacitance Vs. Reverse Voltage

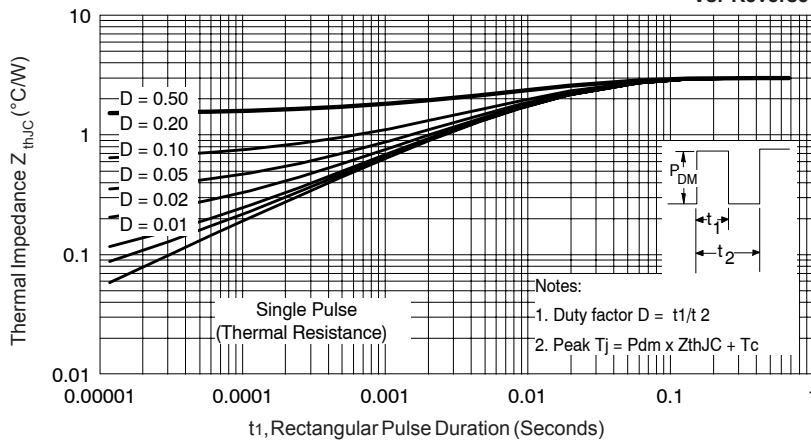
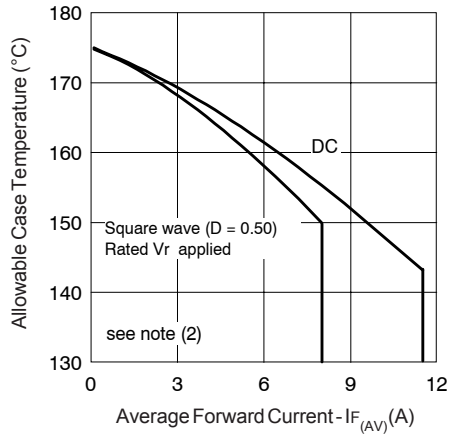
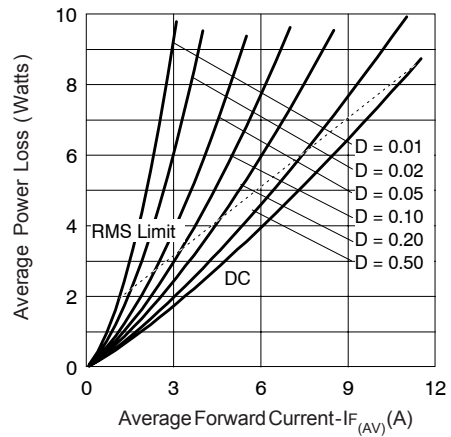

Fig. 4 - Max. Thermal Impedance  $Z_{thJC}$  Characteristics



**Fig. 5 - Max. Allowable Case Temperature Vs. Average Forward Current**



**Fig. 6 - Forward Power Loss Characteristics**

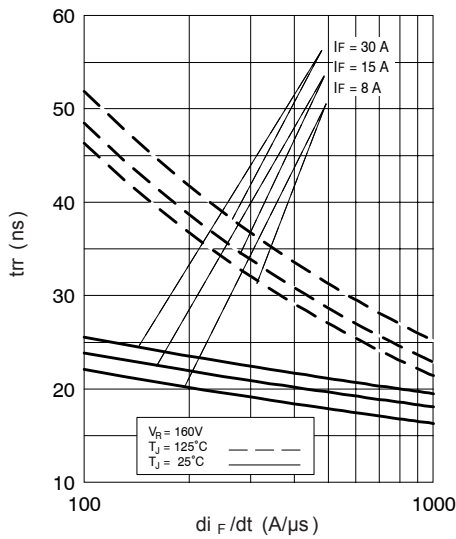

**Fig. 7 - Typical Reverse Recovery vs.  $di_F/dt$**

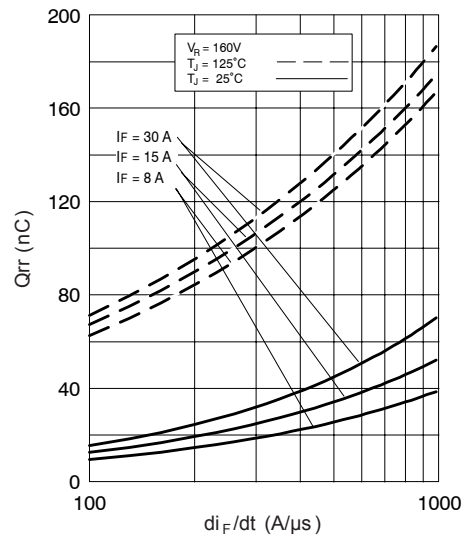

**Fig. 8 - Typical Stored Charge vs.  $di_F/dt$**

(2) Formula used:  $T_C = T_J - (Pd + Pd_{REV}) \times R_{thJC}$ ;  
 $Pd = \text{Forward Power Loss} = I_{F(AV)} \times V_{FM} @ (I_{F(AV)} / D)$  (see Fig. 6);  
 $Pd_{REV} = \text{Inverse Power Loss} = V_{R1} \times I_R (1 - D); I_R @ V_{R1} = \text{rated } V_R$

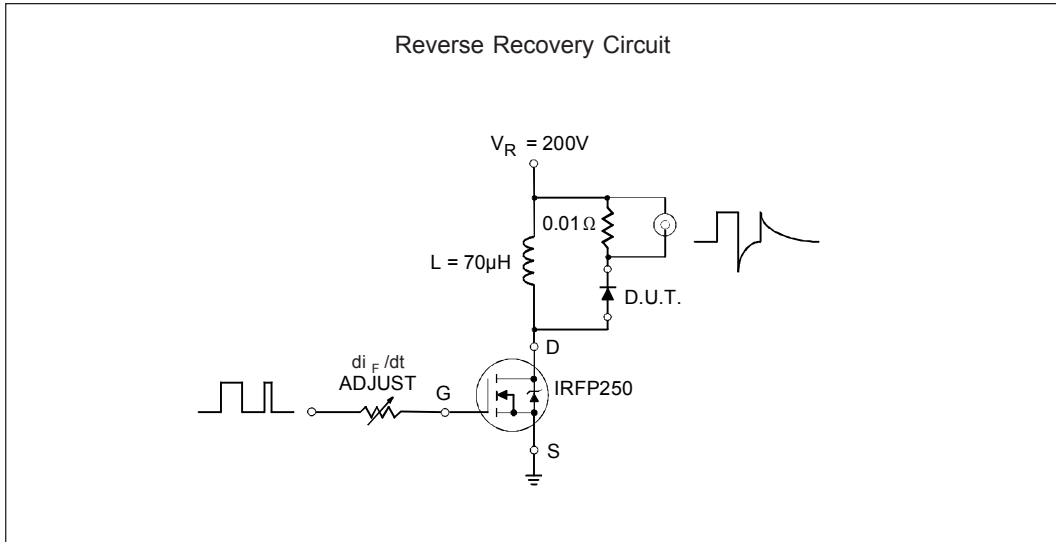

Fig. 9- Reverse Recovery Parameter Test Circuit

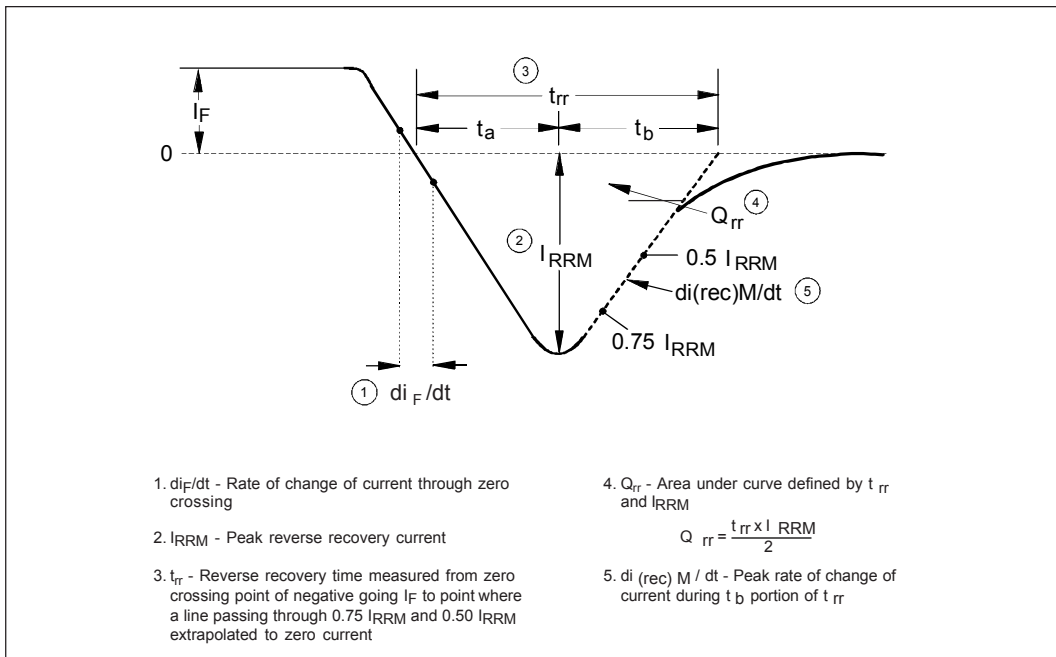
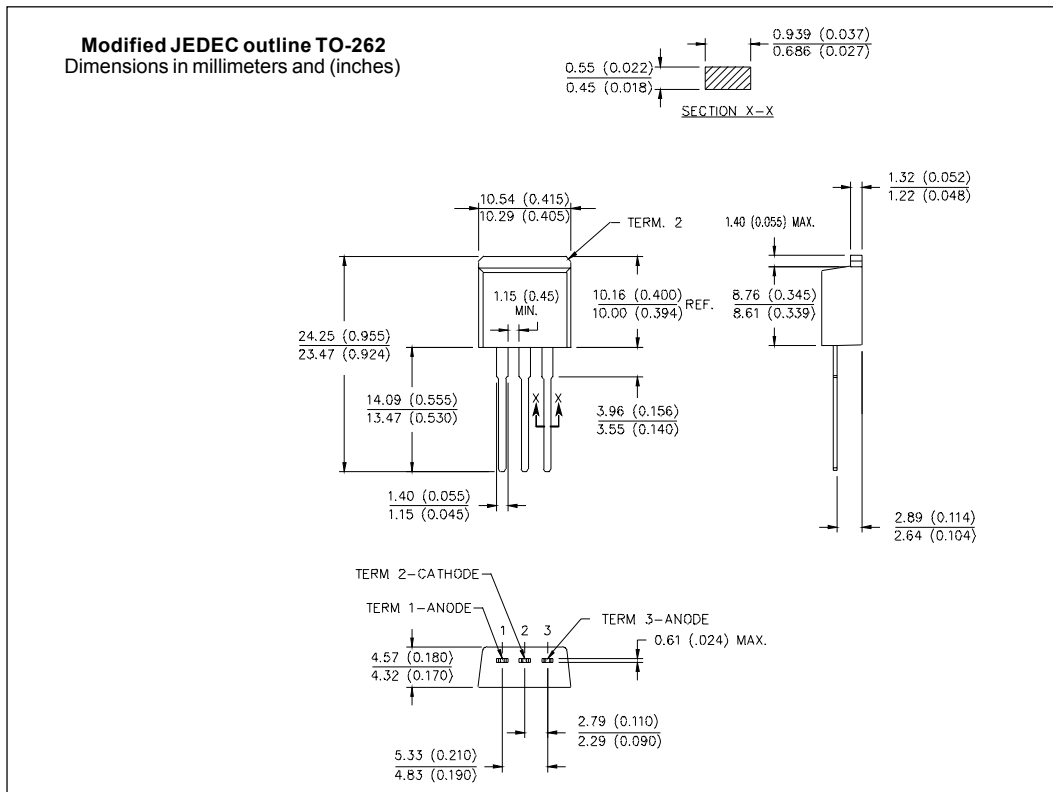
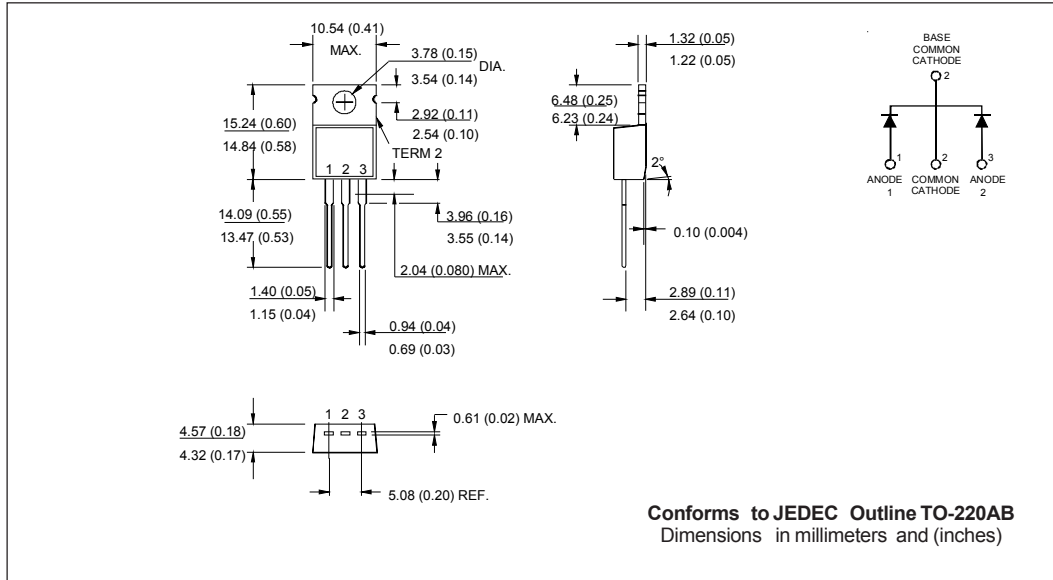
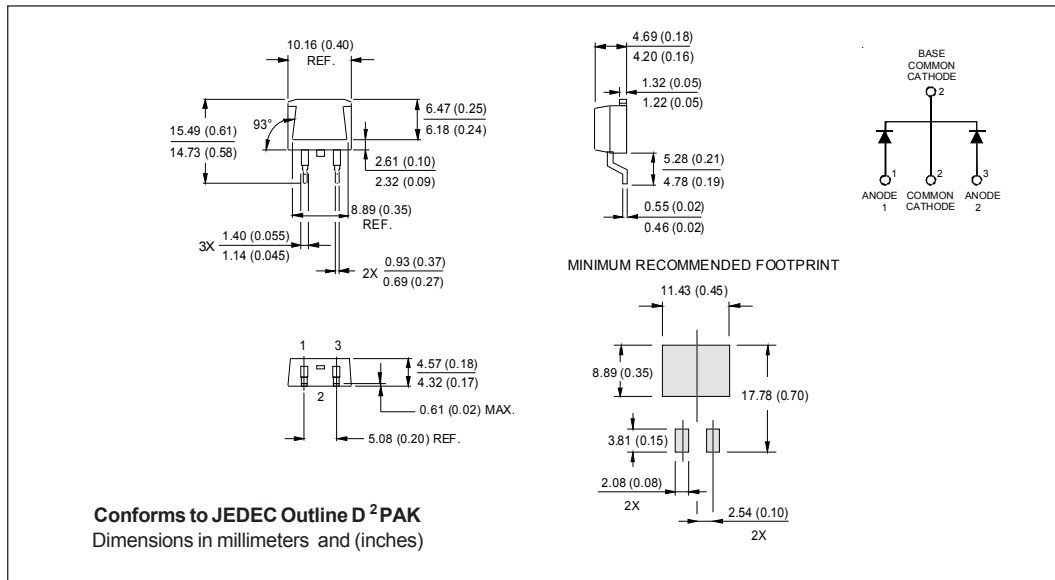

Fig. 10 - Reverse Recovery Waveform and Definitions

Outline Table



Outline Table



Ordering Information Table

Device Code

<b>MUR</b>	<b>B</b>	<b>16</b>	<b>20</b>	<b>CT</b>	<b>-1</b>
1	2	3	4	5	6

- 1** - Ultrafast MUR Series
- 2** - B = D<sup>2</sup>Pak / TO-262  
None = TO-220AB
- 3** - Current Rating (16 = 16A)
- 4** - Voltage Rating (20 = 200V)
- 5** - CT = Center Tap (Dual) TO-220 / D<sup>2</sup>PAK / TO-262
- 6** - "-1" = TO-262 Option

MUR1620CT, MURB1620CT, MURB1620CT-1

Bulletin PD-20718 rev. C 12/03

International  
**IOR** Rectifier

---

Data and specifications subject to change without notice.  
This product has been designed and qualified for Industrial Level.  
Qualification Standards can be found on IR's Web site.

International  
**IOR** Rectifier

**IR WORLD HEADQUARTERS:** 233 Kansas St., El Segundo, California 90245, USA Tel: (310) 252-7105  
TAC Fax: (310) 252-7309  
Visit us at [www.irf.com](http://www.irf.com) for sales contact information. 12/03