

MAX2691

L2 Band GPS Low-Noise Amplifier

General Description

The MAX2691 low-noise amplifier (LNA) is designed for GPS L2 applications. Designed in Maxim's advanced SiGe process, the device achieves high gain and low noise figure while maximizing the input-referred 1dB compression point and the 3rd-order intercept point. The MAX2691 provides a high gain of 17.5dB and sub 1dB noise figure.

The device operates from a +1.6V to +3.6V single supply. The optional shutdown feature in the device reduces the typical supply current to 4µA. The device is available in a very small, lead-free, RoHS-compliant, 0.86mm x 0.86mm x 0.65mm wafer-level package (WLP).

Applications

Precision Navigation
Telematics (Asset Tracking and Management)
Avionics

Features

- ◆ High-Power Gain: 17.5dB
- ◆ Low-Noise Figure: 0.93dB
- ◆ Integrated 50Ω Output Matching Circuit
- ◆ Low Supply Current: 4.3mA
- ◆ Wide Supply Voltage Range: 1.6V to 3.6V
- ◆ Low Bill of Materials: One Inductor, Two Capacitors
- ◆ Small Footprint: 0.86mm x 0.86mm
- ◆ Thin Profile: 0.65mm
- ◆ 0.4mm-Pitch Wafer-Level Package (WLP)

Ordering Information appears at end of data sheet.

For related parts and recommended products to use with this part, refer to www.maxim-ic.com/MAX2691.related.

Typical Application Circuit

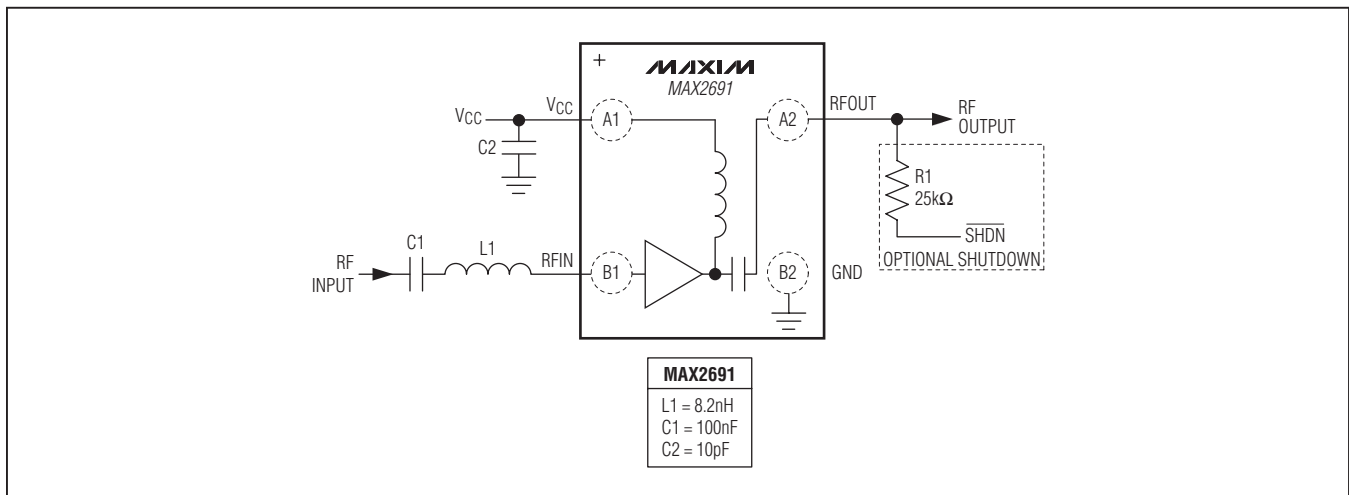

L2 Band GPS Low-Noise Amplifier

ABSOLUTE MAXIMUM RATINGS

V _{CC} to GND.....	-0.3V to +3.6V	Operating Temperature Range	-40°C to +85°C
Other Pins to GND (except RFIN)	-0.3V to (+ Operating V _{CC} + 0.3V)	Junction Temperature	+150°C
Maximum Current into RF Input	10mA	Storage Temperature Range.....	-65°C to +160°C
Maximum RF Input Power	+5dBm	Lead Temperature (soldering, 10s)	Reflow Profile (Note 1)
Continuous Power Dissipation (T _A = +70°C) 4-Bump WLP (derates 9.7mW/°C above +70°C)	776mW	Soldering Temperature (reflow)	+260°C

Note 1: Refer to Application Note 1891: *Wafer-Level Packaging (WLP) and Its Applications*.

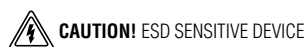

Stresses beyond those listed under "Absolute Maximum Ratings" may cause permanent damage to the device. These are stress ratings only, and functional operation of the device at these or any other conditions beyond those indicated in the operational sections of the specifications is not implied. Exposure to absolute maximum rating conditions for extended periods may affect device reliability.

DC ELECTRICAL CHARACTERISTICS

(MAX2691 EV kit, V_{CC} = 1.6V to 3.6V, T_A = -40°C to +85°C, no RF signals are applied. Typical values are at V_{CC} = 2.85V and T_A = +25°C, unless otherwise noted.) (Note 2)

PARAMETER	CONDITIONS	MIN	TYP	MAX	UNITS
Supply Voltage		1.6	2.85	3.6	V
Supply Current	SHDN = high		4.3		mA
	Shutdown mode, SHDN = low		4.0	20	μA
Digital Input Logic-High	(Note 3)	1.2			V
Digital Input Logic-Low	(Note 3)			0.45	V

AC ELECTRICAL CHARACTERISTICS

(MAX2691 EV kit, V_{CC} = 1.6V to 3.6V, T_A = -40°C to +85°C, f_{RFIN} = 1227MHz. Typical values are at V_{CC} = 2.85V and T_A = +25°C, unless otherwise noted.) (Note 2)

PARAMETER	CONDITIONS	MIN	TYP	MAX	UNITS
RF Frequency	L2 band		1227		MHz
Power Gain (Note 4)	V _{CC} = 2.85V	13.3	17.5		dB
	V _{CC} = 1.6V	13.1	17.4		
Noise Figure	V _{CC} = 1.6V to 3.3V		0.93		dB
In-Band 3rd-Order Input Intercept Point	(Note 5)		-3.0		dBm
Input 1dB Compression Point	(Note 6)		-8.5		dBm
Input Return Loss			10.9		dB

L2 Band GPS Low-Noise Amplifier

AC ELECTRICAL CHARACTERISTICS (continued)

(MAX2691 EV kit, $V_{CC} = 1.6V$ to $3.6V$, $T_A = -40^{\circ}C$ to $+85^{\circ}C$, $f_{RFIN} = 1227MHz$. Typical values are at $V_{CC} = 2.85V$ and $T_A = +25^{\circ}C$, unless otherwise noted.) (Note 2)

PARAMETER	CONDITIONS	MIN	TYP	MAX	UNITS
Output Return Loss			15.6		dB
Reverse Isolation			45		dB

Note 2: Min and max limits guaranteed by test at $T_A = +25^{\circ}C$ and guaranteed by design and characterization at $T_A = -40^{\circ}C$ and $T_A = +85^{\circ}C$, unless otherwise noted.

Note 3: Min and max limits guaranteed by test at $T_A = +25^{\circ}C$.

Note 4: Min limit guaranteed by design and characterization.

Note 5: Measured with the two tones located at 1MHz and 2MHz offset from the center of the GPS band with -30dBm/tone.

Note 6: Measured with a tone located at 5MHz offset from the center of the GPS band.

Typical Operating Characteristics

(MAX2691 EV kit. Typical values are at $V_{CC} = 2.85V$, $T_A = +25^{\circ}C$, and $f_{RFIN} = 1227MHz$, unless otherwise noted.)

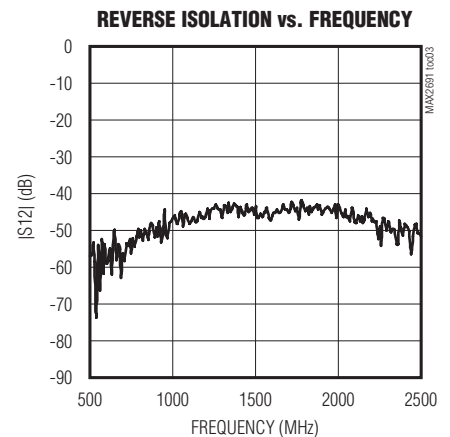
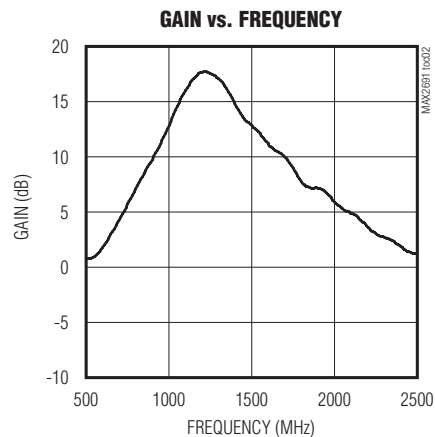
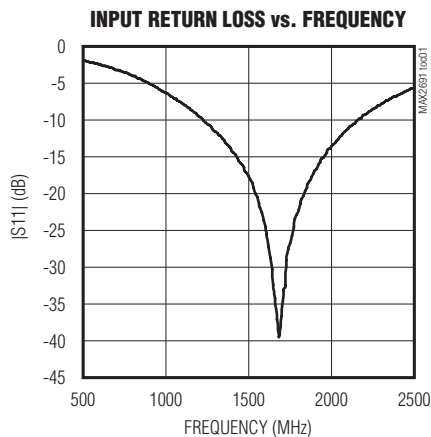

L2 Band GPS Low-Noise Amplifier

Typical Operating Characteristics (continued)

(MAX2691 EV kit. Typical values are at $V_{CC} = 2.85V$, $T_A = +25^\circ C$, and $f_{RFIN} = 1227MHz$, unless otherwise noted.)

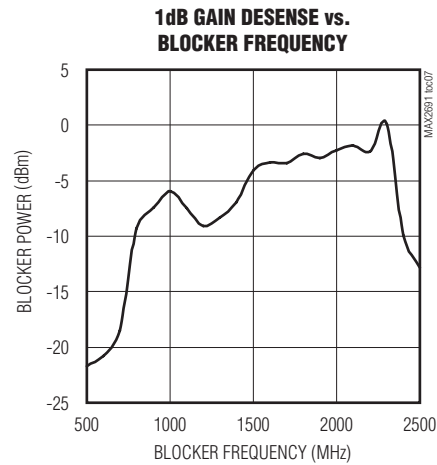
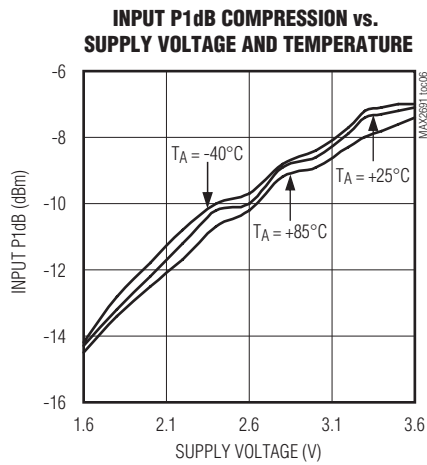
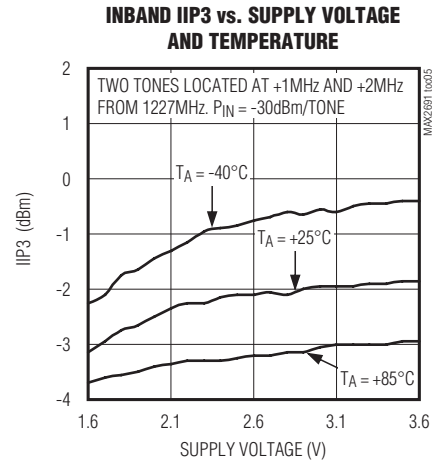
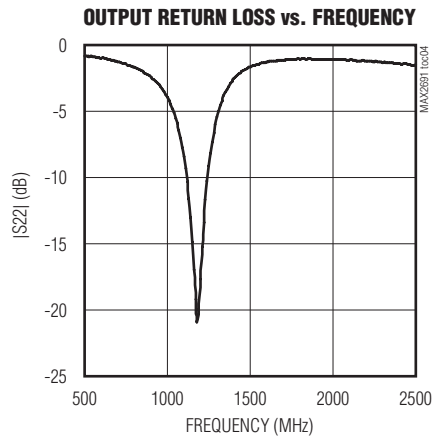

L2 Band GPS Low-Noise Amplifier

Bump Configuration

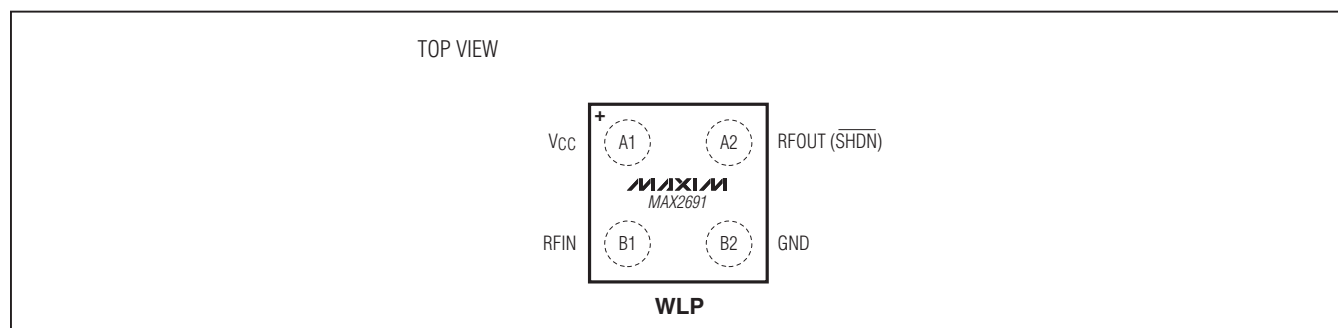

Bump Description

BUMP	NAME	FUNCTION
A1	V _{CC}	Supply Voltage. Bypass to ground with a 10pF capacitor as close as possible to the IC.
A2	RFOUT (SHDN)	RF Output/SHDN Input. RFOUT is internally matched to 50Ω and pulled up to V _{CC} through a 1MΩ resistor. SHDN is shared with the RFOUT bump. The device is in active mode by default once V _{CC} is applied. RFOUT(SHDN) can be pulled to a DC low through a 25kΩ resistor to shut down the IC.
B1	RFIN	RF Input. Requires a DC-blocking capacitor and external matching components.
B2	GND	Ground. Connect to the PCB ground plane.

Detailed Description

The MAX2691 LNA is designed for GPS L2 applications. The device features a power-shutdown control mode to eliminate the need for an external supply switch. The device achieves high gain, low noise figure, and excellent linearity.

Input and Output Matching

The MAX2691 requires an off-chip input match. Only an inductor in series with a DC-blocking capacitor is needed to form the input matching circuit. The [Typical Application Circuit](#) shows the recommended input-matching network. These values are optimized for the best simultaneous gain, noise figure, and return loss performance. Reducing the input coupling capacitor results in a lower IIP3. The device integrates an on-chip output matching to 50Ω at the output, eliminating the need for external matching components. [Table 1](#) lists typical device S parameters and K_f values. Typical noise parameters are shown in [Table 2](#).

Shutdown

The MAX2691 includes an optional shutdown feature to turn off the entire chip. The device is placed in active

mode by default once V_{CC} is applied, due to the on-chip pullup resistor to V_{CC} at the RFOUT bump (shared with the SHDN input). To shut down the part, apply a logic-low to the RFOUT bump through an external resistor with an adequate value, e.g., 25kΩ, in order not to load the RF output signal during active operation.

Applications Information

A properly designed PCB is essential to any RF microwave circuit. Use controlled-impedance lines on all high-frequency inputs and outputs. Bypass V_{CC} with decoupling capacitors located close to the device. For long V_{CC} lines, it may be necessary to add decoupling capacitors. Locate these additional capacitors further away from the device package. Proper grounding of the GND pin is essential. If the PCB uses a topside RF ground, connect it directly to the GND pin. For a board where the ground is not on the component layer, connect the GND pin to the board with multiple vias close to the package.

Refer to www.maxim-ic.com for the MAX2691 EV kit schematic, Gerber data, PADS layout file, and BOM information.

L2 Band GPS Low-Noise Amplifier

Table 1. Typical S Parameter Values and K-Factor

FREQ. (MHz)	S11 MAG (dB)	S11 PHASE (DEGREES)	S21 MAG (dB)	S21 PHASE (DEGREES)	S12 MAG (dB)	S12 PHASE (DEGREES)	S22 MAG (dB)	S22 PHASE (DEGREES)	K _f
700	-2.1	-78.1	3.5	-175.7	-54.0	113.3	-1.3	-124.9	16.75126
800	-2.5	-87.1	6.0	175.7	-47.7	112.0	-1.6	-143.3	8.847551
900	-2.8	-96.2	8.8	163.0	-55.5	85.4	-2.4	-162.8	22.33037
1000	-3.1	-104.3	11.7	146.2	-53.8	54.0	-3.9	175.0	19.54059
1100	-3.4	-112.3	14.4	119.2	-46.3	33.8	-8.3	149.5	9.366309
1200	-3.7	-119.4	16.0	83.5	-46.9	15.3	-19.1	-126.9	9.788318
1220	-3.7	-120.7	16.1	75.6	-47.6	-1.0	-14.2	-114.7	10.25069
1240	-3.7	-122.4	16.0	67.9	-49.4	20.3	-10.9	-114.4	12.09861
1260	-3.8	-123.7	15.9	60.1	-49.7	14.9	-8.7	-118.5	12.1323
1280	-3.8	-125.0	15.6	52.8	-47.3	-6.0	-6.9	-124.3	8.793041
1300	-3.8	-126.6	15.2	46.0	-43.5	19.6	-5.7	-130.2	5.277003
1400	-4.0	-133.5	13.4	18.4	-44.9	-22.8	-2.6	-157.6	4.94144
1500	-4.1	-140.3	11.3	-0.5	-48.5	-21.4	-1.6	-179.3	6.656188
1600	-4.1	-147.6	9.4	-15.6	-47.7	-23.6	-1.3	163.8	5.983826
1700	-4.1	-154.6	7.8	-28.5	-44.8	-16.5	-1.0	148.8	4.18904

Table 2. Typical Noise Parameters (V_{CC} = 2.85V, T_A = +25°C)

FREQUENCY (MHz)	F _{MIN} (dB)	Γ _{OPT}	Γ _{OPT} ANGLE	R _N (f)
1200	0.66	0.45	47	8.37
1210	0.66	0.45	48	8.35
1220	0.66	0.45	48	8.33
1230	0.66	0.45	48	8.30
1240	0.66	0.45	49	8.28
1250	0.66	0.45	49	8.26
1260	0.66	0.45	50	8.24
1270	0.67	0.45	50	8.22
1280	0.67	0.44	50	8.20
1290	0.67	0.44	51	8.18
1300	0.67	0.44	51	8.17

Ordering Information

PART	TEMP RANGE	PIN-PACKAGE
MAX2691EWS+T	-40°C to +85°C	4 WLP

+Denotes a lead(Pb)-free/RoHS-compliant package.
T = Tape and reel.

Chip Information

PROCESS: SiGe BiCMOS

Package Information

For the latest package outline information and land patterns (footprints), go to www.maxim-ic.com/packages. Note that a "+", "#", or "-" in the package code indicates RoHS status only. Package drawings may show a different suffix character, but the drawing pertains to the package regardless of RoHS status.

PACKAGE TYPE	PACKAGE CODE	OUTLINE NO.	LAND PATTERN NO.
4 WLP	W40A0+1	21-0480	Refer to Application Note 1891

MAX2691

L2 Band GPS Low-Noise Amplifier

Revision History

REVISION NUMBER	REVISION DATE	DESCRIPTION	PAGES CHANGED
0	12/11	Initial release	—

Maxim cannot assume responsibility for use of any circuitry other than circuitry entirely embodied in a Maxim product. No circuit patent licenses are implied. Maxim reserves the right to change the circuitry and specifications without notice at any time. The parametric values (min and max limits) shown in the Electrical Characteristics table are guaranteed. Other parametric values quoted in this data sheet are provided for guidance.

Maxim Integrated Products, 120 San Gabriel Drive, Sunnyvale, CA 94086 408-737-7600 _____ **7**