

### Typical Applications

The HMC877LC3 is ideal for:

- Synchronization of clock and data
- Transponder design
- Broadband Test & Measurement
- RF ATE Applications

### Features

- Very Wide Bandwidth: 8 - 23 GHz
- Continuous Adjustable Delay Range: 500° (1.4 UI<sup>[1]</sup>)
- Single-Ended or Differential Operation
- Adjustable Differential Output Voltage  
Swing: 500 - 950 mVp-p @ 16 GHz
- Delay Control Modulation Bandwidth: 2.5 GHz
- Single Supply: +3.3V
- 16 Lead Ceramic 3x3mm SMT Package: 9mm<sup>2</sup>

### Functional Diagram

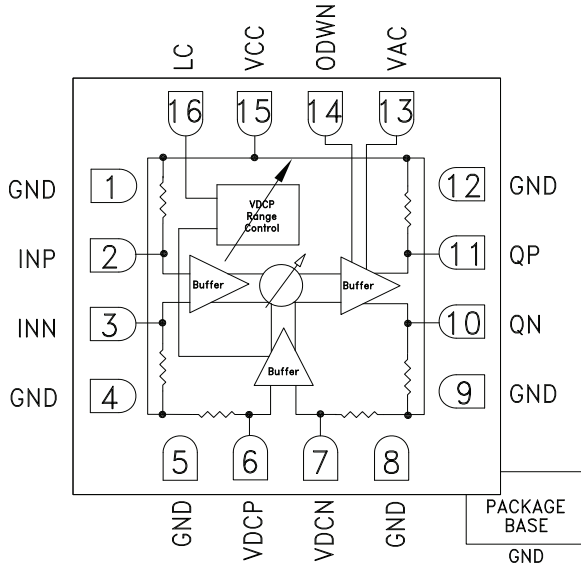

### General Description

The HMC877LC3 is a phase shifter/time delay with 0 to 500°(1.4 UI) continuously adjustable shift/delay range. The delay control is linearly monotonic with respect to the differential control voltage (VDCP, VDCN) and the control input has a modulation bandwidth of 2.5 GHz. The device provides a differential output voltage with constant amplitude for single-ended or differential input voltages above the input sensitivity level, while the output voltage swing may be adjusted using the VAC control pin. The HMC877LC3 features internal temperature compensation and bias circuitry to minimize delay variations with temperature. The device also features a delay control voltage range adjustment pin, LC. All RF input and outputs of the HMC877LC3 are internally terminated with 50 Ohms to Vcc, and may either be AC or DC coupled. Output pins can be connected directly to a 50 Ohm to Vcc terminated system, while DC blocking capacitors must be used if the terminated system input is 50 Ohms to a DC voltage other than Vcc. The HMC877LC3 is available in ROHS-compliant 3x3 mm SMT package.

### Electrical Specifications, $T_A = +25^\circ C$ , $V_{CC} = 3.3V$ , $GND=ODWN = 0V$

Parameter	Conditions	Min.	Typ.	Max.	Units
Power Supply Voltage	± %5 Tolerance	3.135	3.3	3.465	V
Power Supply Current	ODWN = 0V	175	190	215	mA
Phase Shift Range	@ 10 GHz		504		Deg
	@ 16 GHz		498		Deg
	@ 22 GHz		485		Deg
Time Delay Range	@ 10 GHz		1.4		UI
	@ 16 GHz		1.38		UI
	@ 22 GHz		1.35		UI
Delay Control Modulation Bandwidth			2.5		GHz
Delay Control Voltage (VDCP)		VCC-0.6		VCC+0.6	V

[1] The UI stands for unit interval

## BROADBAND TIME DELAY & PHASE SHIFTER SMT, 8 - 23 GHz

**Electrical Specifications,  $T_A = +25^\circ\text{C}$ ,  $V_{CC} = 3.3\text{V}$ ,  $GND=ODWN = 0\text{V}$  (Continued)**

Parameter	Conditions	Min.	Typ.	Max.	Units
Output Amplitude Control Voltage (VAC)		0.65	1.5	1.8	V
Output Amplitude	Single-Ended, peak-to-peak @ 10 GHz	350		670	mVp-p
	Single-Ended, peak-to-peak @ 16 GHz	310		630	mVp-p
	Single-Ended, peak-to-peak @ 22 GHz	280		535	mVp-p
Harmonic Suppression* ( $f_{in}$ is fundamental frequency)	VDCP=VDCN=3.3 V @ 22 GHz ( $f_{in}-f_{in}/2$ )	26		48	dBc
	VDCP=VDCN=3.3 V @ 8 GHz ( $f_{in}-3f_{in}/2$ )	28		62	dBc
	VDCP=VDCN=3.3 V @ 16 GHz ( $f_{in}-2f_{in}$ )	30	32	36	dBc
Input Return Loss	frequency < 23 GHz		12		dB
Output Return Loss	frequency < 23 GHz		6		dB
RMS Jitter	@ 16 GHz		0.45		ps
Rise Time, tr	@ 16 GHz		10		ps
Fall Time, tf	@ 16 GHz		11		ps
Time Delay Temperature Sensitivity	@ 16 GHz		0.05		deg/ $^\circ\text{C}$
Propagation Delay, td	VDCP=2.7V, VDCN=3.3V @ 16GHz (Relative to zero phase shift)		140		ps

\* Harmonic suppression measurements are taken for single-ended inputs and outputs.

**Time Delay vs. Frequency** [1][2][3]

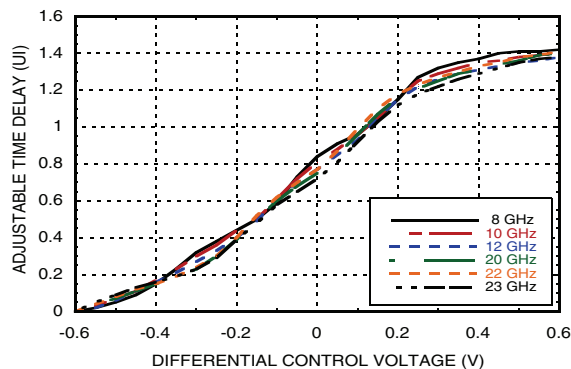

**Time Delay vs. Bias Voltage** [2][3][4]

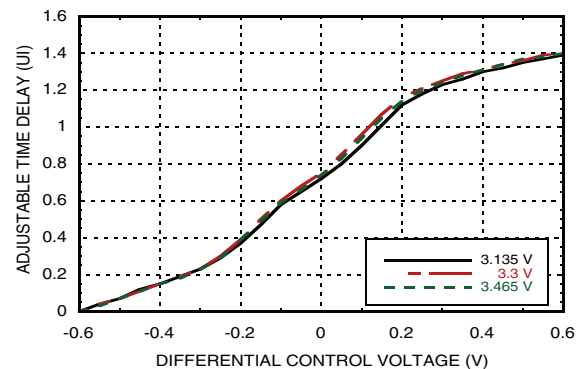

[1]  $V_{CC} = 3.3\text{V}$

[2]  $ODWN = 0\text{V}$ ,  $VDCN=VCC$

[3] On the x-axis differential control voltage represents VDCP-VDCN voltage

[4] Input Frequency: 20 GHz

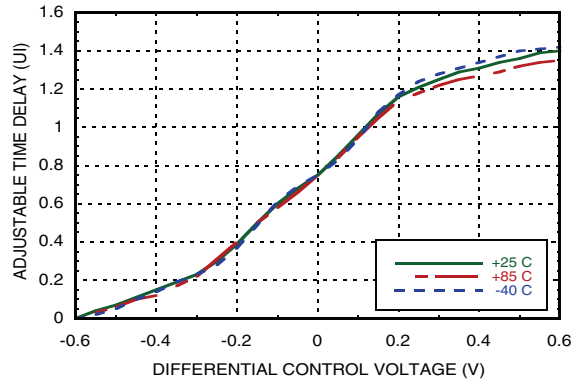
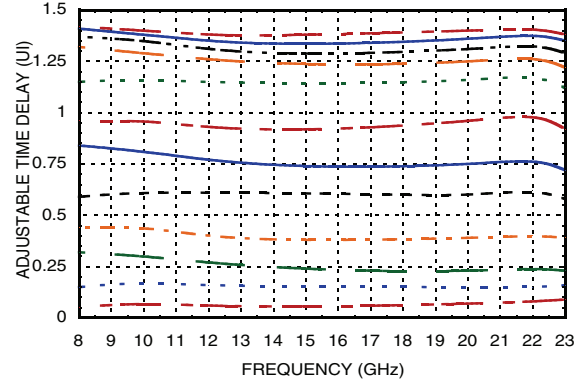
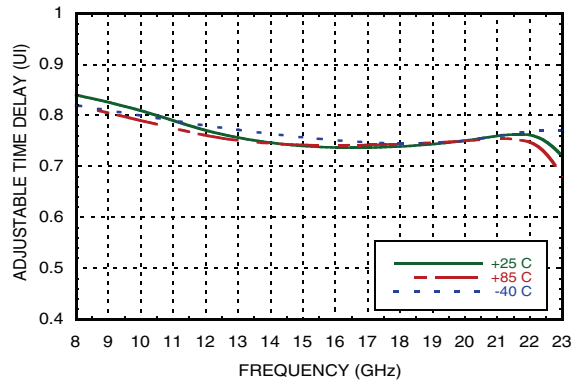
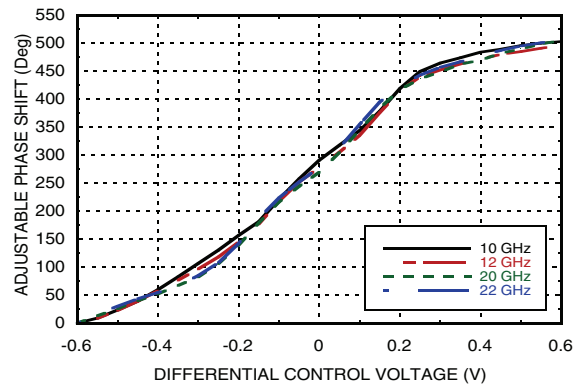
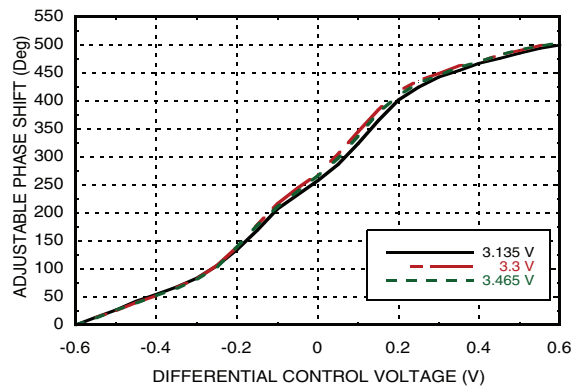
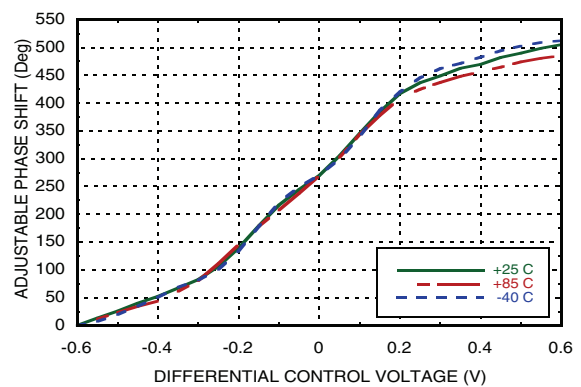
**Time Delay vs. Temperature** <sup>[1][2][3][4]</sup>

**Time Delay vs. Control Voltage**  
**@ VDCP=2.7V to 3.9V with 0.1V step** <sup>[1][2]</sup>

**Time Delay vs. Temperature @ VDCP=3.3V**  
**(Relative to VDCP=VCC-0.6V)** <sup>[1][2][6]</sup>

**Phase Shift vs. Frequency** <sup>[1][2][3]</sup>

**Phase Shift vs. Bias Voltage** <sup>[2][3][4]</sup>

**Phase Shift vs. Temperature** <sup>[1][2][3][4]</sup>

<sup>[1]</sup> VCC = 3.3V

<sup>[2]</sup> ODWN = 0 V, VDCN = VCC

<sup>[3]</sup> On the x-axis differential control voltage represents VDCP-VDCN voltage

<sup>[4]</sup> Input Frequency: 20 GHz



## BROADBAND TIME DELAY & PHASE SHIFTER SMT, 8 - 23 GHz

**Phase Shift vs. Control Voltage**  
@  $V_{DCP}=2.7V$  to  $3.9V$  with  $0.1V$  step [1][2][3]

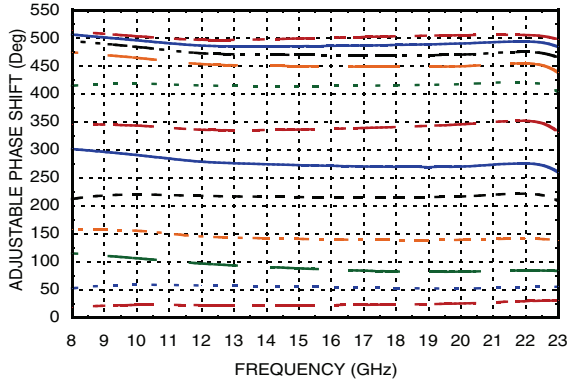

**Phase Shift vs. Temperature @  $V_{DCP}=3.3V$**   
(Relative to  $V_{DCP}=V_{CC}-0.6V$ ) [1][2]

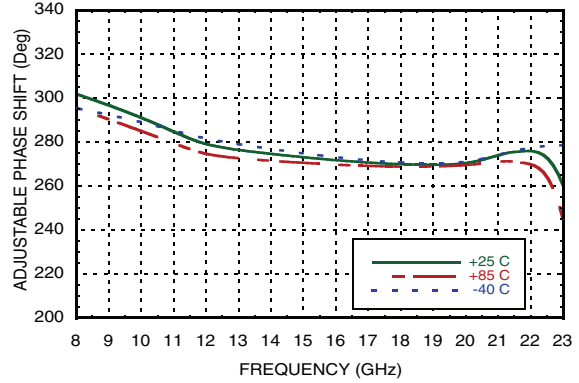

**Phase Error vs. Control Voltage**  
@  $f_{mean}=16$  GHz [1][2][3][4]

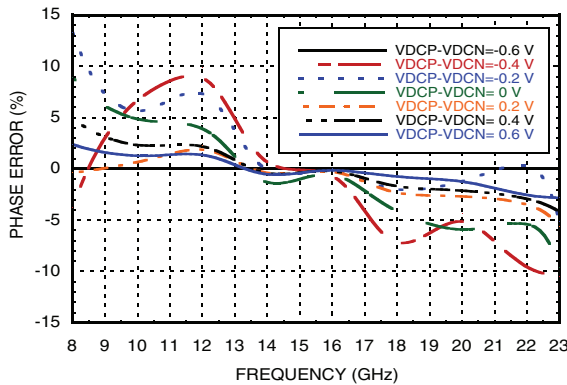

**Phase Shift vs. Control Voltage**  
@ 10 GHz [1][2][3][4]

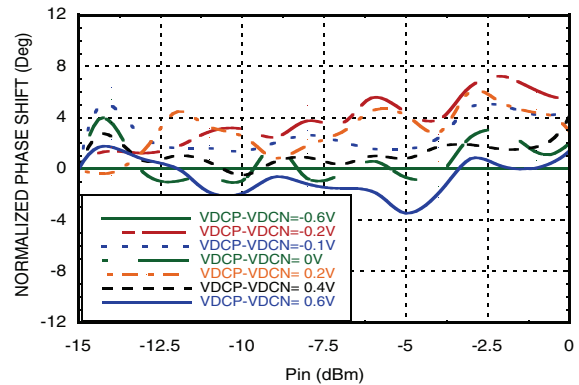

**Phase Shift vs. Control Voltage**  
@ 22 GHz [1][2][3][4]

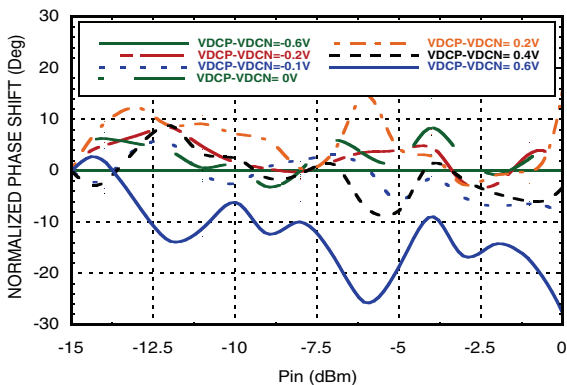

**DC Current vs. Temperature** [2][5]

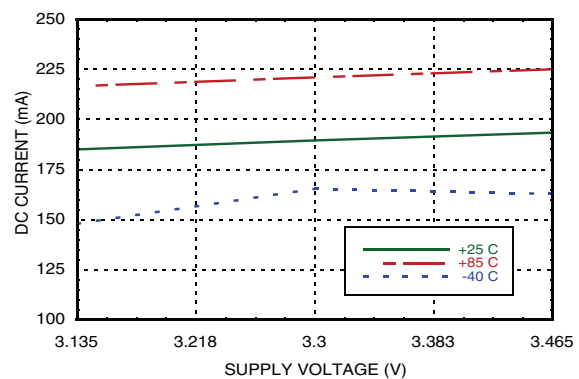

[1]  $V_{CC} = 3.3V$  [2]  $ODWN = 0V$ ,  $V_{DCN} = V_{CC}$  [3]  $25^{\circ}C$   
[4]  $V_{DCP} - V_{DCN} = -0.6V$  is taken as reference level [5]  $V_{DCP} = 3.3V$  and input frequency is 20 GHz

**Single-Ended Output Swing vs. Supply Voltage** [1][2][3]

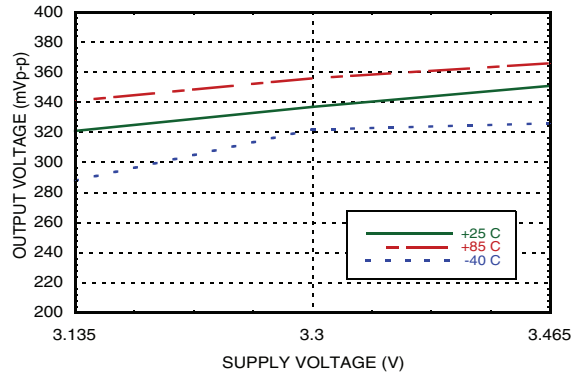

**Single-Ended Output Swing vs. Frequency** [1][2][3][4]

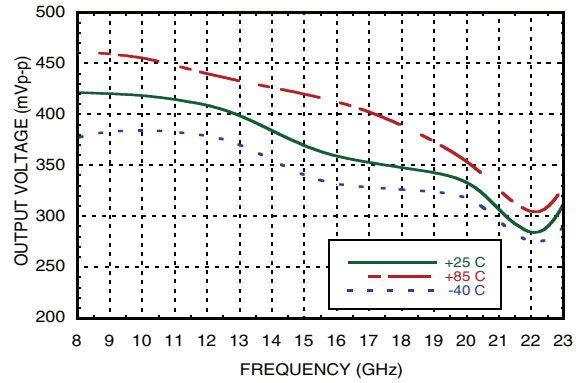

**Single-Ended Output Swing vs. Control Voltage** [1][4][5]

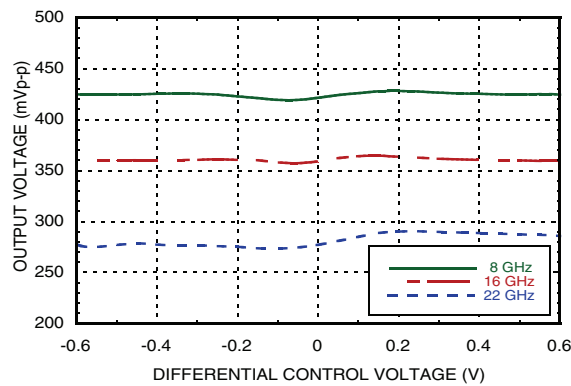

**Duty Cycle Distortion @ 16 GHz** [1][4][5]

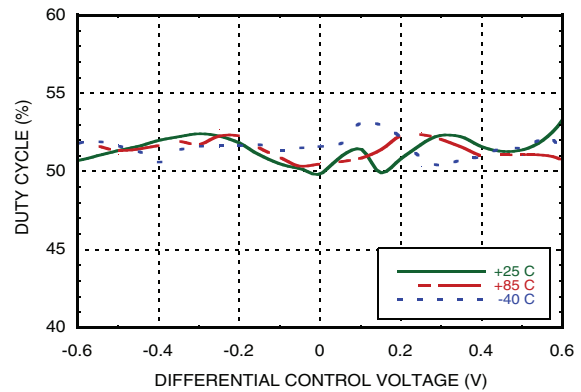

**Rise Time vs. Temperature @ 16 GHz** [1][4][5]

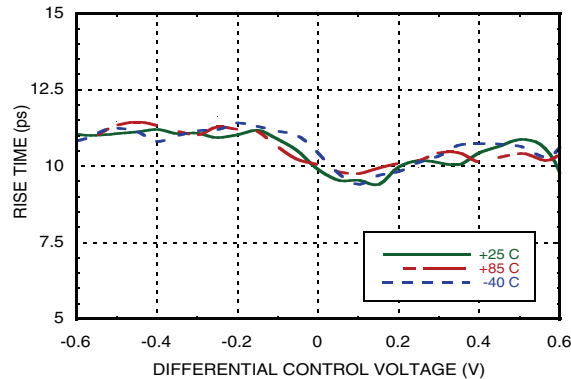

**Fall Time vs. Temperature @ 16 GHz** [1][4][5]

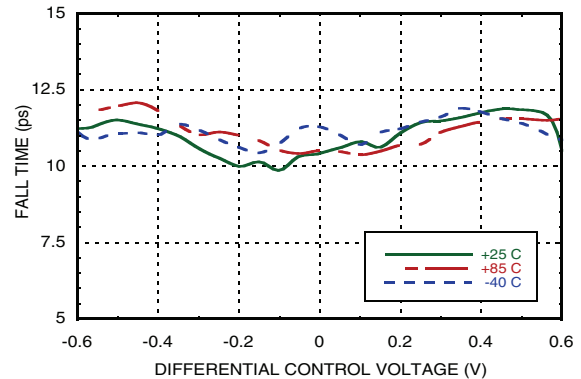

[1] ODWN=0V, VDCN=VCC

[2] Input Frequency: 20 GHz

[3] VDCP=3.3V

[4] VCC=3.3V

[5] On the x-axis differential control voltage represents VDCP-VDCN voltage

### RMS Jitter vs. Temperature

@ 16 GHz<sup>[1][2][3][4]</sup>

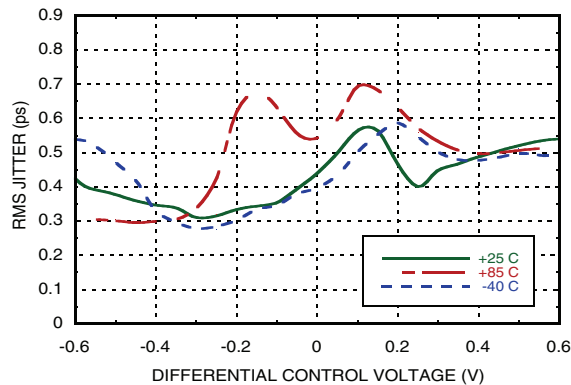

### RMS Jitter vs. Bias Voltage

@ 16 GHz<sup>[1][3][4]</sup>

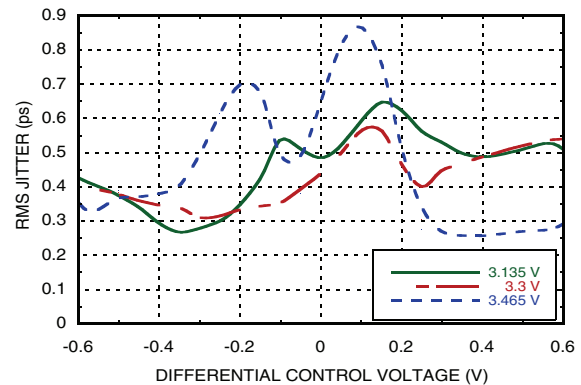

### $P_{fin} - P_{fin/2}$ Output Power Difference vs. Control Voltage<sup>[1][2][5]</sup>

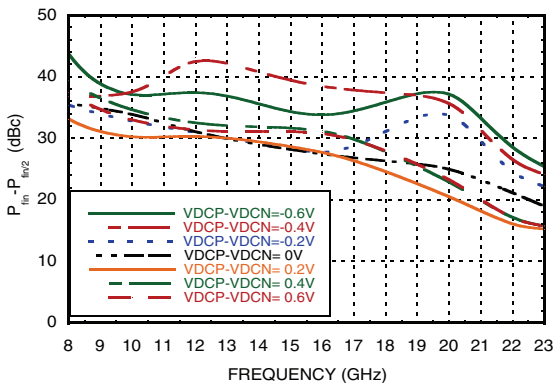

### $P_{fin} - P_{3fin/2}$ Output Power Difference vs. Control Voltage<sup>[1][2][5]</sup>

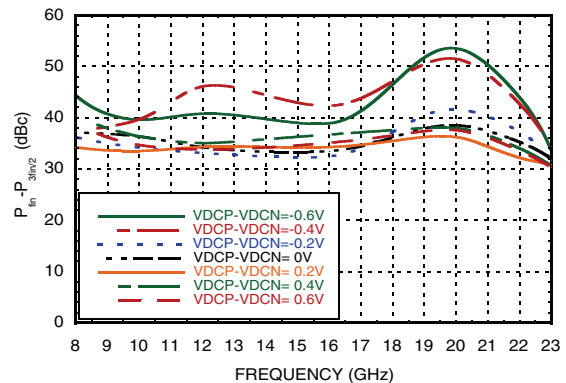

### Second Harmonic vs. Control Voltage<sup>[1][2][5]</sup>

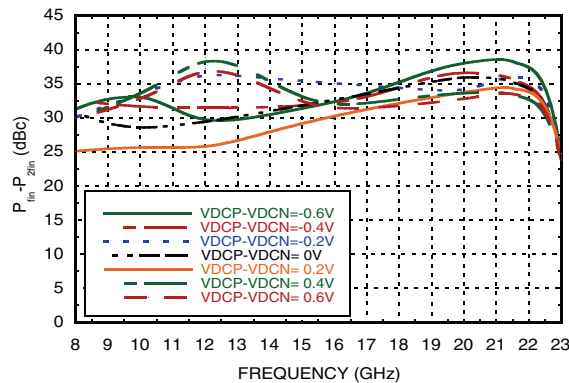

[1] ODWN= 0V, VDCN=VCC

[2] VCC=3.3V

[3] On the x-axis differential control voltage represents VDCP-VDCN voltage

[4] Source jitter was not deembedded

[5] fin is the fundamental frequency

**Modulation Signal Bandwidth vs. Temperature** <sup>[1][2][7]</sup>

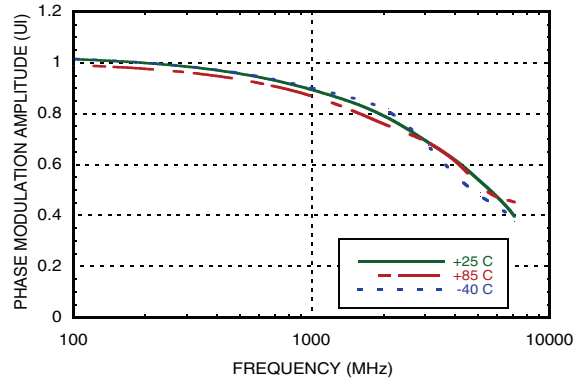

**Input Return Loss vs. Frequency** <sup>[1][3]</sup>

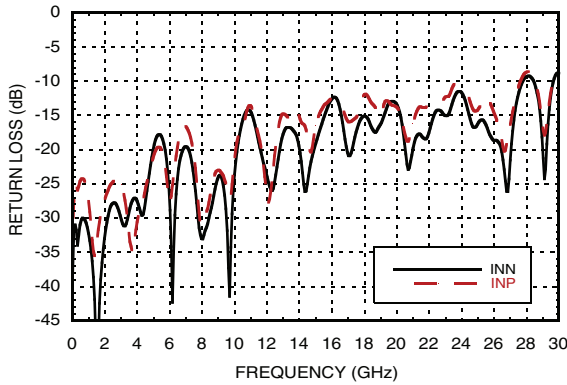

**Output Return Loss vs. Frequency** <sup>[1][3]</sup>

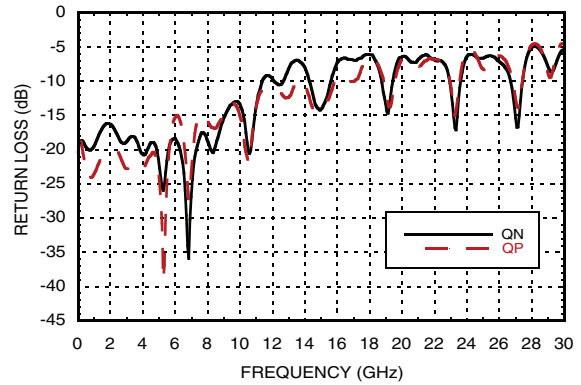

[1] VCC= 3.3 V, ODWN=0V [2] -6.8 dBm input power was applied to VDCP, VDCN is 50 Ohms terminated and fin=15 GHz  
 [3] VDCP=VDCN=VCC

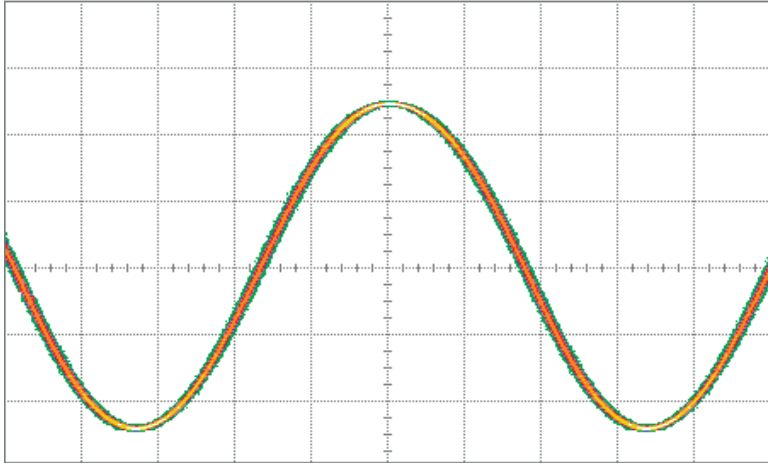
**Output Eye Diagram Snapshot for 15 GHz Input Signal**

Time Scale: 10 ps/div

Amplitude Scale: 81.8 mV/div

Test Conditions:

VCC=3.3 V, ODWN=0 V

VDCP = 300 mVpp @ 1 MHz

VDCN is 50 Ohms terminated

Measurement Results:

RMS Jitter: 0.3 ps

Peak to peak Jitter: 1.78 ps

Rise Time: 11.78 ps

Fall Time: 11.78 ps

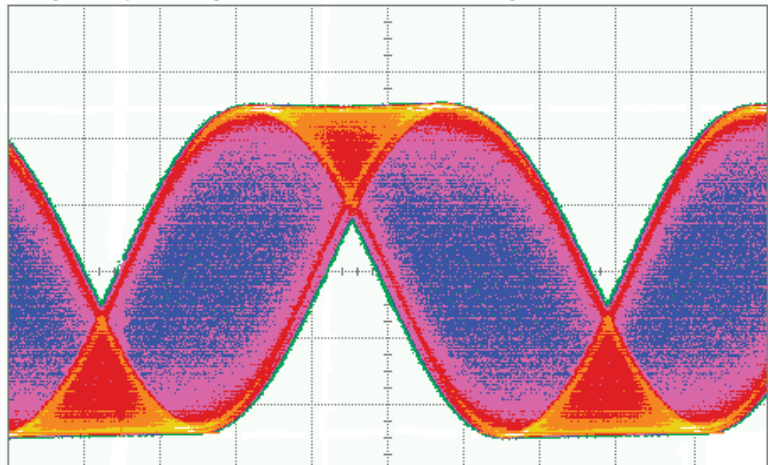
**Output Eye Diagram Continuous Snapshot for 15 GHz Input Signal**

Time Scale: 10 ps/div

Amplitude Scale: 81.8 mV/div

Test Conditions:

VCC=3.3 V, ODWN=0 V

VDCP = 300 mVpp @ 1 MHz

VDCN is 50 Ohms terminated

Measurement Result:

26.8 ps (0.4 UI )



**Absolute Maximum Ratings**

Power Supply Voltage (Vcc)	-0.5V to +3.75V
Input Voltage (V <sub>IN</sub> ), Output Voltage (V <sub>OUT</sub> )	Vcc -1.2V to Vcc+0.6V
Control Voltage (V <sub>DCP</sub> ), Delay Control Voltage Range Adjustment (L <sub>C</sub> ), Amplitude Control Voltage (V <sub>AC</sub> )	0 to Vcc+0.6V
Channel Temperature (Tc)	125 °C
Continuous Pdiss (T = 85 °C) (derate 35.8 mW/°C above 85 °C)	1.43 W
Thermal Resistance (junction to ground paddle)	27.9 °C/W
Storage Temperature	-65 to +125 °C
Operating Temperature	-40 to +85°C
ESD Sensitivity (HBM)	Class 1A

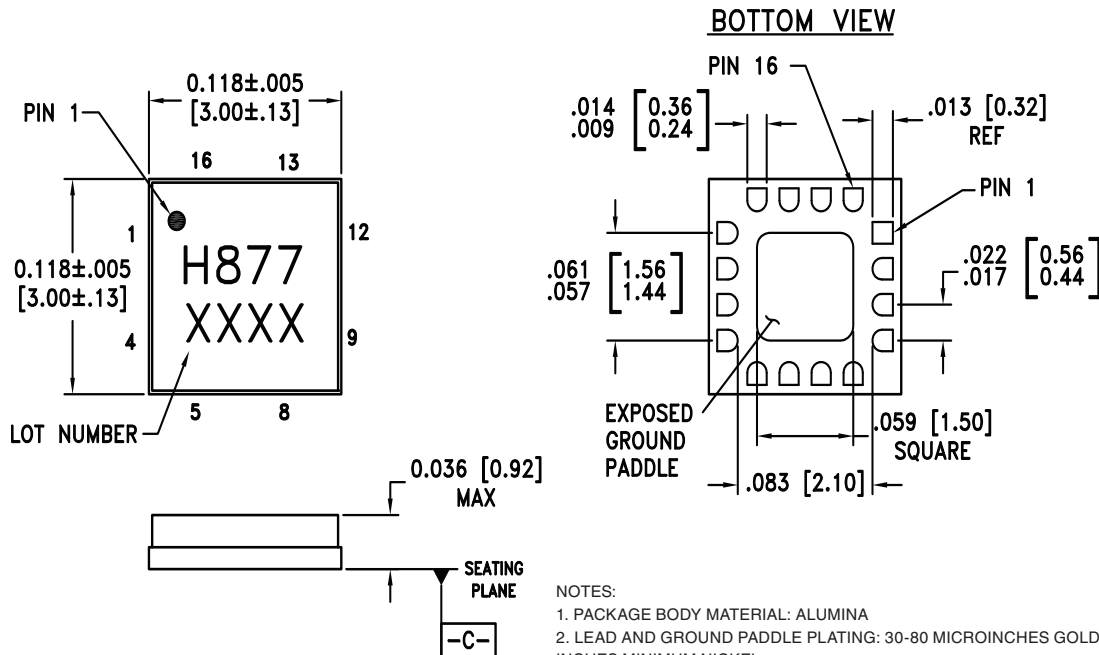

ELECTROSTATIC SENSITIVE DEVICE  
OBSERVE HANDLING PRECAUTIONS

**Outline Drawing**

### Pin Descriptions

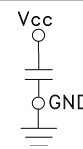
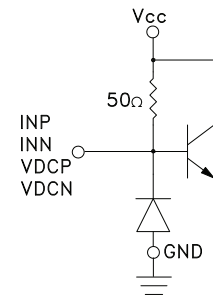
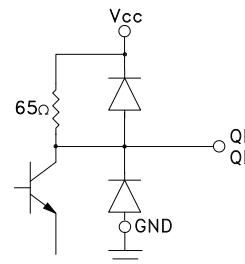
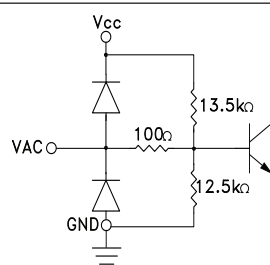
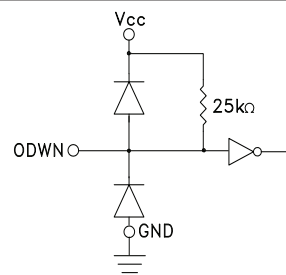
Pin Number	Function	Description	Interface Schematic
1, 4-5, 8-9,12	GND	Signal grounds should be connected to 0V. Ground paddle must be connected to DC ground	
2, 3, 6, 7	INP INN VDCP VDCN	Differential signal inputs.	
10, 11	QN QP	Differential signal outputs.	
13	VAC	The output amplitude control pin.	
14	ODWN	Enable pin of the output. It should be connected to GND to enable the part. When it is connected to VCC or floated the output is set to VCC.	
15	VCC	The supply voltage of the part.	

### Pin Descriptions (Continued)

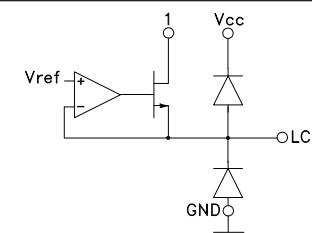
Pin Number	Function	Description	Interface Schematic
16	LC	This pin enables the control of the linearity level of Control Voltage vs. Phase Shift/Time Delay. Compromise is between linearity level and wideness of the Phase Shift/Time Delay tuning range. For optimum tuning range and linearity balance, R2=R3 are chosen as 4.7 kOhms.	

### Application Circuit

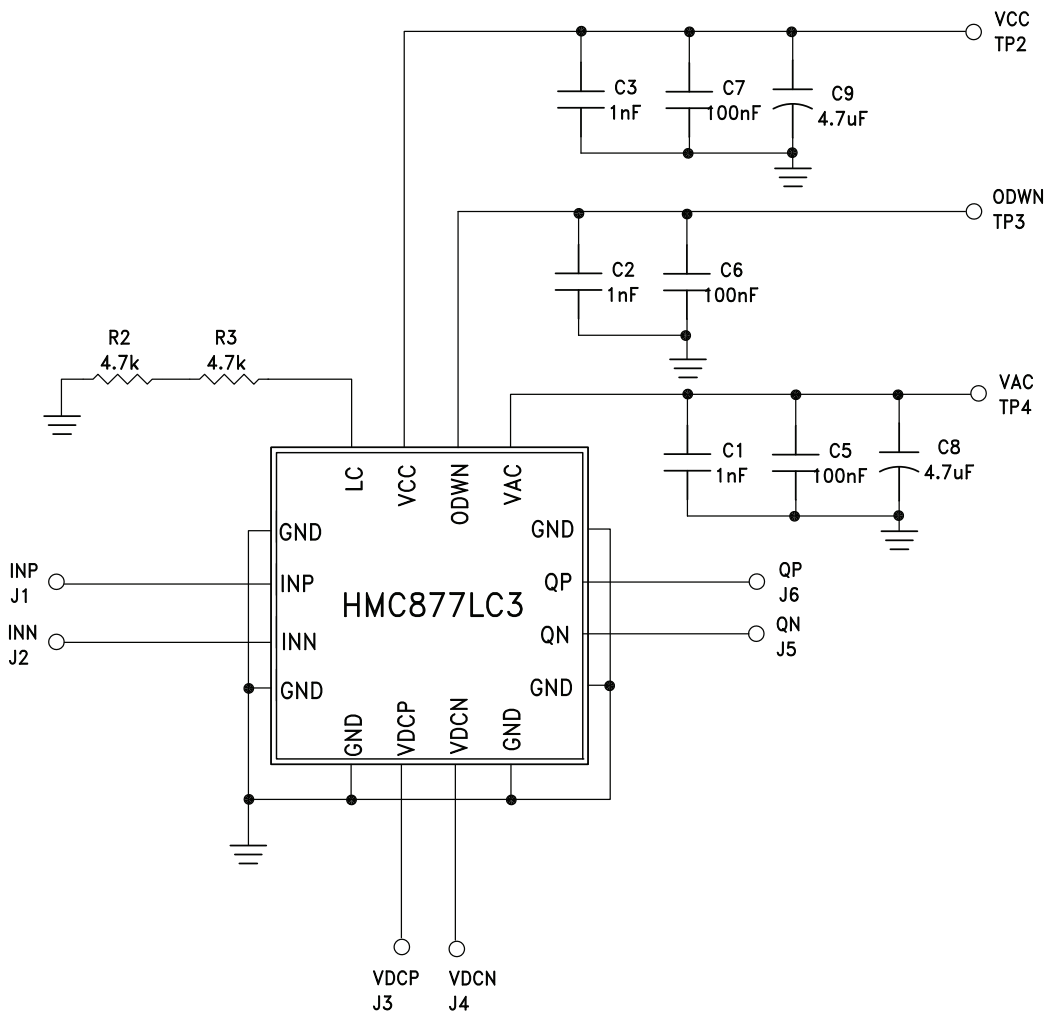

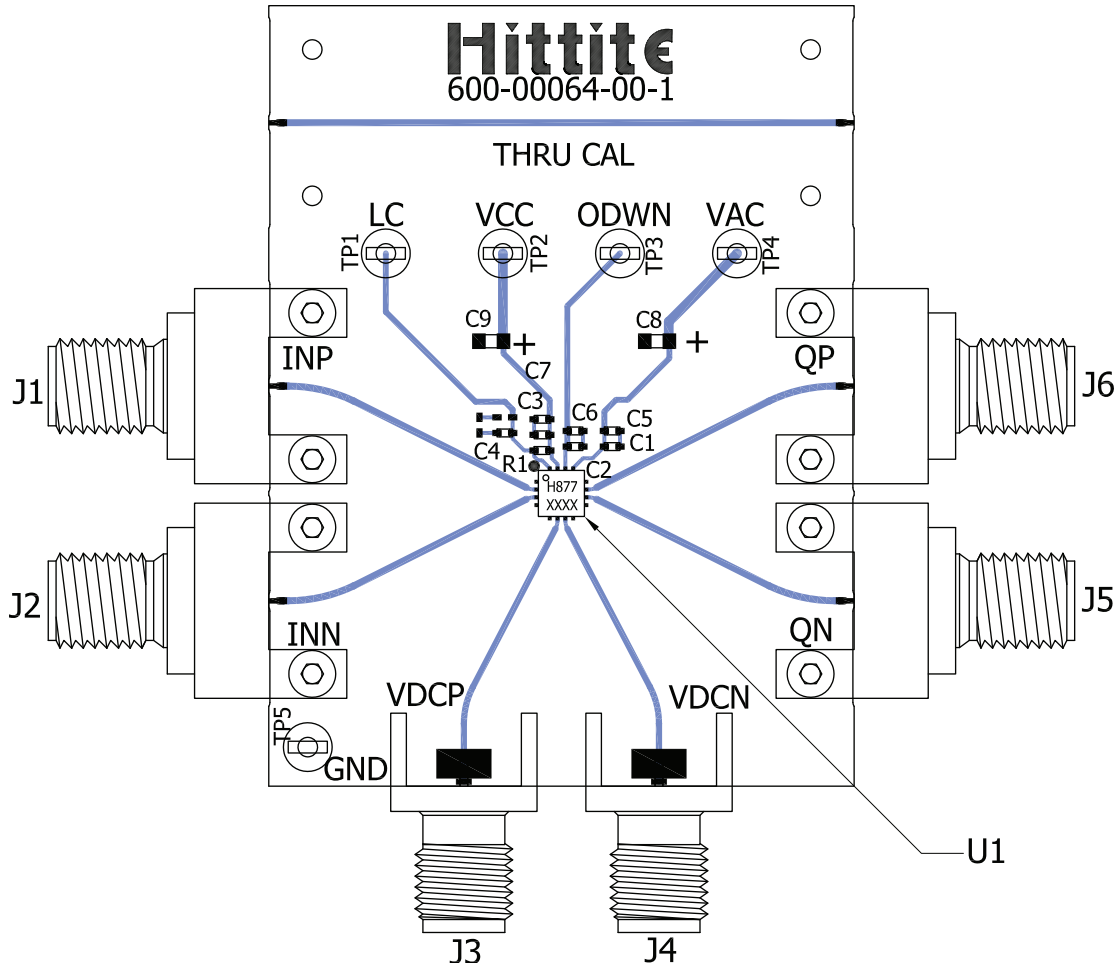
**Evaluation PCB**

**List of Materials for Evaluation PCB EVAL01-HMC877LC3<sup>[1]</sup>**

Item	Description
J1 - J2, J5-J6	K Connector
J3-J4	SMA Connector
TP1-TP5	DC Pin
C1-C3	1000 pF Capacitor, 0402 Pkg.
C5-C7	0.1 $\mu$ F Capacitor, 0402 Pkg.
C8-C9	4.7 $\mu$ F Capacitor, Tantalum
R2-R3	4.7 kOhm Resistor, 0402 Pkg.
U1	HMC877LC3 Analog Phase Shifter/ Broadband Time Delay
PCB [2]	600-00064-00 Evaluation Board

[1] Reference this number when ordering complete evaluation PCB

[2] Circuit Board Material: Rogers 4350 or Arlon 25 FR

The circuit board used in the application should use RF circuit design techniques. Signal lines should have 50 Ohm impedance while the package ground leads and exposed paddle should be connected directly to the ground plane similar to that shown. A sufficient number of via holes should be used to connect the top and bottom ground planes. The evaluation board should be mounted to an appropriate heat sink. The evaluation circuit board shown is available from Hittite upon request.