

Parameter	Rating	Units
AC Operating Voltage	120	$V_{rms}$
Load Current	1	$A_{rms}$
On State Voltage Drop	1.6	$V_{rms}$ (at $I_L = 1A_{rms}$ )

### Features

- Load Current up to  $1A_{rms}$
- $400V_p$  Blocking Voltage
- 5mA Sensitivity
- Zero-Crossing Detection
- DC Control, AC Output
- Optically Isolated
- TTL and CMOS Compatible
- Low EMI and RFI Generation
- High Noise Immunity
- Machine Insertable, Wave Solderable
- Flammability classification rating of V-0

### Applications

- Programmable Control
- Process Control
- Power Control Panels
- Remote Switching
- Gas Pump Electronics
- Contactors
- Large Relays
- Solenoids
- Motors
- Heaters

### Description

The CPC1945G is an AC Solid State Relay (SSR) using patented waveguide coupling with dual power SCR outputs to produce an alternative to optocoupler and Triac circuits. The switches are robust enough to provide a blocking voltage of up to  $400V_p$ . In addition, tightly controlled zero-cross circuitry ensures switching of AC loads without the generation of transients.

The input and output circuits are optically coupled to provide  $3750V_{rms}$  of isolation and noise immunity between control and load circuits. As a result, the CPC1945G is well suited for industrial environments where electromagnetic interference could disrupt the operation of electromechanical relays.

### Approvals

- UL Recognized Component: File E69938
- CSA Certified Component: Certificate 1172007

### Ordering Information

Part #	Description
CPC1945G	4-Pin (16-Pin Body) DIP (25/Tube)

### Pin Configuration

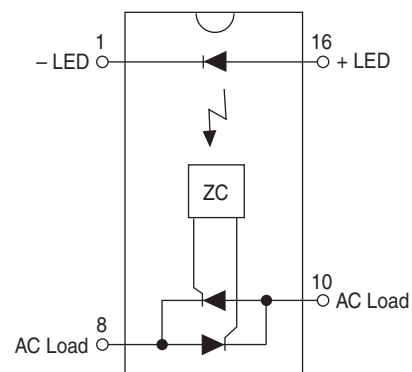

**Absolute Maximum Ratings @ 25°C**

Parameter	Ratings	Units
Blocking Voltage	400	V <sub>P</sub>
Reverse Input Voltage	5	V
Input Control Current Peak (10ms)	100	mA
	1	A
Input Power Dissipation <sup>1</sup>	150	mW
P <sub>MAX</sub> , Total Package Dissipation <sup>2</sup>	1600	mW
Isolation Voltage, Input to Output	3750	V <sub>rms</sub>
Operational Temperature	-40 to +85	°C
Storage Temperature	-40 to +125	°C

*Absolute Maximum Ratings are stress ratings. Stresses in excess of these ratings can cause permanent damage to the device. Functional operation of the device at conditions beyond those indicated in the operational sections of this data sheet is not implied.*

<sup>1</sup> Derate linearly 1.33 mW / °C

<sup>2</sup> Derate linearly 16.6 mW / °C

**Electrical Characteristics @ 25°C**

Parameters	Conditions	Symbol	Min	Typ	Max	Units			
<b>Output Characteristics</b>									
Operating Voltage Range	V <sub>L</sub>	-	20	-	120	V <sub>rms</sub>			
Load Current, Continuous	V <sub>L</sub> =120V <sub>rms</sub>	I <sub>L</sub>	0.005	-	1	A <sub>rms</sub>			
Non-Repetitive Single Cycle Surge Current	-	I <sub>TSM</sub>	-	-	10	A			
Off State Leakage Current	V <sub>L</sub> =400V <sub>P</sub>	I <sub>LEAK</sub>	-	-	1	mA			
On-State Voltage Drop	I <sub>L</sub> =1A <sub>rms</sub>	-	-	-	1.6	V <sub>rms</sub>			
Critical Rate of Rise <sup>3</sup>	-	dV/dt	1000	-	-	V/μs			
Switching Speeds	I <sub>F</sub> =5 mA	-	-	-	-	cycles			
Turn-on							t <sub>on</sub>	-	0.5
Turn-off							t <sub>off</sub>	-	0.5
Zero-Cross Turn-On Voltage	1st half-cycle	-	-	2	10	V			
	Subsequent half-cycle	-	-	1	-	V			
Operating Frequency <sup>1</sup>	-	-	20	-	400	Hz			
Load Power Factor for Guaranteed Turn-On <sup>2</sup>	-	PF	0.25	-	-	-			
<b>Input Characteristics</b>									
Input Control Current <sup>4</sup>	-	I <sub>F</sub>	-	0.8	5	mA			
Input Voltage Drop	I <sub>F</sub> =5mA	V <sub>F</sub>	0.9	1.2	1.4	V			
Input Drop-out Voltage	-	-	0.8	-	-	V			
Reverse Input Current	V <sub>R</sub> =5V	I <sub>R</sub>	-	-	10	μA			
<b>Common Characteristics</b>									
Input to Output Capacitance	-	C <sub>I/O</sub>	-	3	-	pF			

<sup>1</sup> Zero Cross 1st half-cycle @ <100Hz

<sup>2</sup> Snubber circuits may be required at low power factors.

<sup>3</sup> Tested in accordance with EIA/NARM standard RS-443.

<sup>4</sup> For high noise environments, use I<sub>F</sub>=10mA.

**PERFORMANCE DATA\***

**Typical LED Forward Voltage Drop**  
( $I_F=5\text{mA}$ ,  $T_A=25^\circ\text{C}$ )

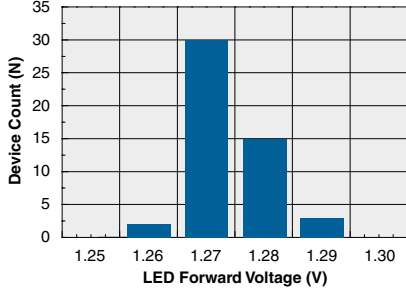

**Typical On-State Voltage Distribution**  
( $I_L=1\text{A}_{\text{rms}}$ ,  $T_A=25^\circ\text{C}$ )

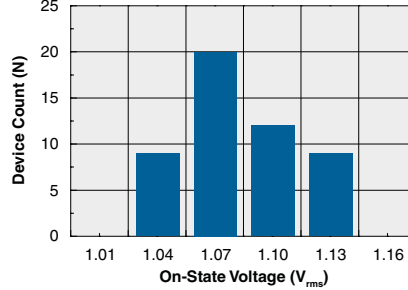

**Typical Blocking Voltage Distribution**  
( $T_A=25^\circ\text{C}$ )

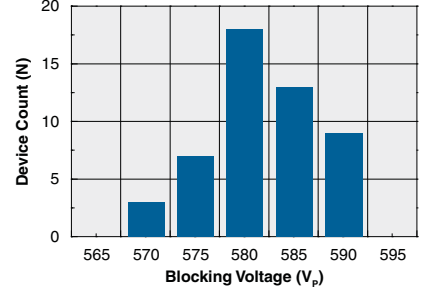

**Typical  $I_F$  for Switch Operation**  
( $I_L=1\text{A}_{\text{rms}}$ ,  $T_A=25^\circ\text{C}$ )

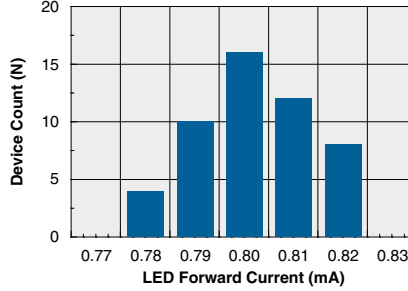

**Typical LED Forward Voltage Drop vs. Temperature**

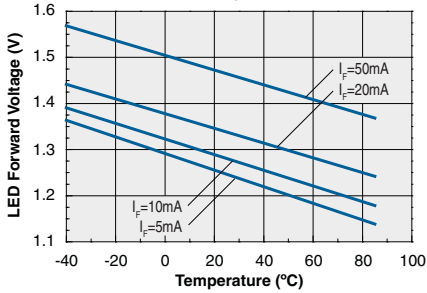

**Typical  $I_F$  for Switch Operation vs. Temperature**  
( $I_L=500\text{mA}_{\text{rms}}$ )

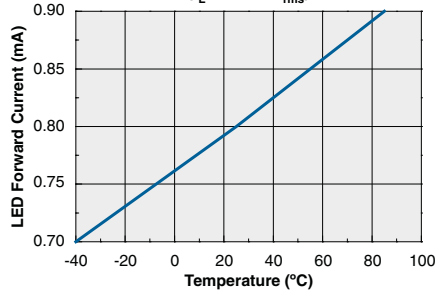

**Typical On-State Voltage vs. Temperature**  
( $I_L=500\text{mA}_{\text{rms}}$ )

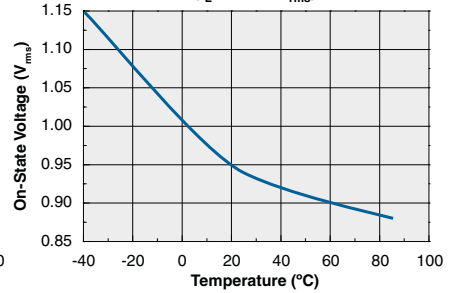

\*The Performance data shown in the graphs above is typical of device performance. For guaranteed parameters not indicated in the written specifications, please contact our application department.

**PERFORMANCE DATA\***

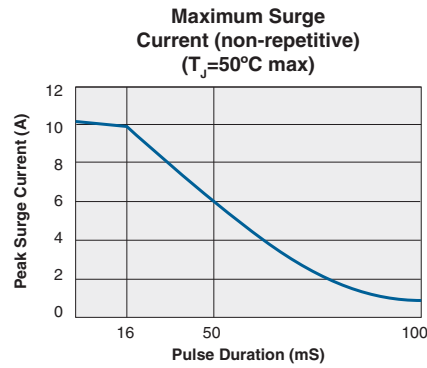
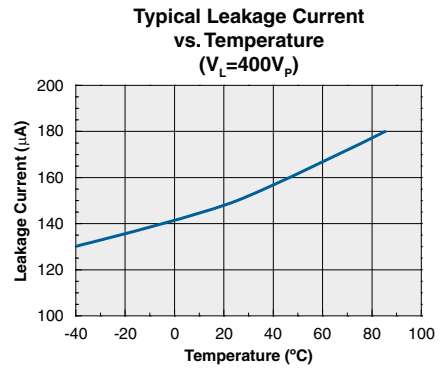
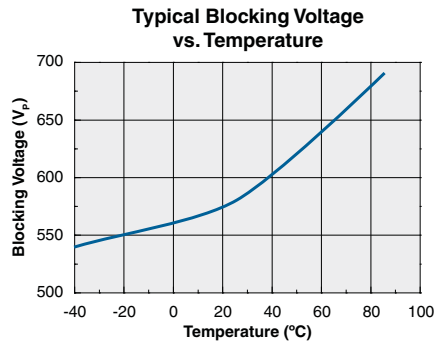
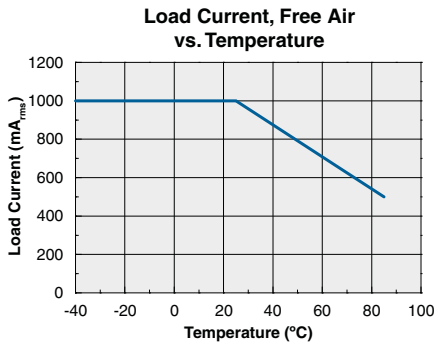

\*The Performance data shown in the graphs above is typical of device performance. For guaranteed parameters not indicated in the written specifications, please contact our application department.

**Manufacturing Information**

**Moisture Sensitivity**



All plastic encapsulated semiconductor packages are susceptible to moisture ingress. Clare classified all of its plastic encapsulated devices for moisture sensitivity according to the latest version of the joint industry standard, **IPC/JEDEC J-STD-020**, in force at the time of product evaluation. We test all of our products to the maximum conditions set forth in the standard, and guarantee proper operation of our devices when handled according to the limitations and information in that standard as well as to any limitations set forth in the information or standards referenced below.

Failure to adhere to the warnings or limitations as established by the listed specifications could result in reduced product performance, reduction of operable life, and/or reduction of overall reliability.

This product carries a **Moisture Sensitivity Level (MSL) rating** as shown below, and should be handled according to the requirements of the latest version of the joint industry standard **IPC/JEDEC J-STD-033**.

Device	Moisture Sensitivity Level (MSL) Rating
CPC1945G	MSL 1

**ESD Sensitivity**



This product is **ESD Sensitive**, and should be handled according to the industry standard **JESD-625**.

**Reflow Profile**

This product has a maximum body temperature and time rating as shown below. All other guidelines of **J-STD-020** must be observed.

Device	Maximum Temperature x Time
CPC1945G	245 °C for 30 seconds

**Board Wash**

Clare recommends the use of no-clean flux formulations. However, board washing to remove flux residue is acceptable. Since Clare employs the use of silicone coating as an optical waveguide in many of its optically isolated products, the use of a short drying bake could be necessary if a wash is used after solder reflow processes. Chlorine- or Fluorine-based solvents or fluxes should not be used. Cleaning methods that employ ultrasonic energy should not be used.



**MECHANICAL DIMENSIONS**

**CPC1945G**

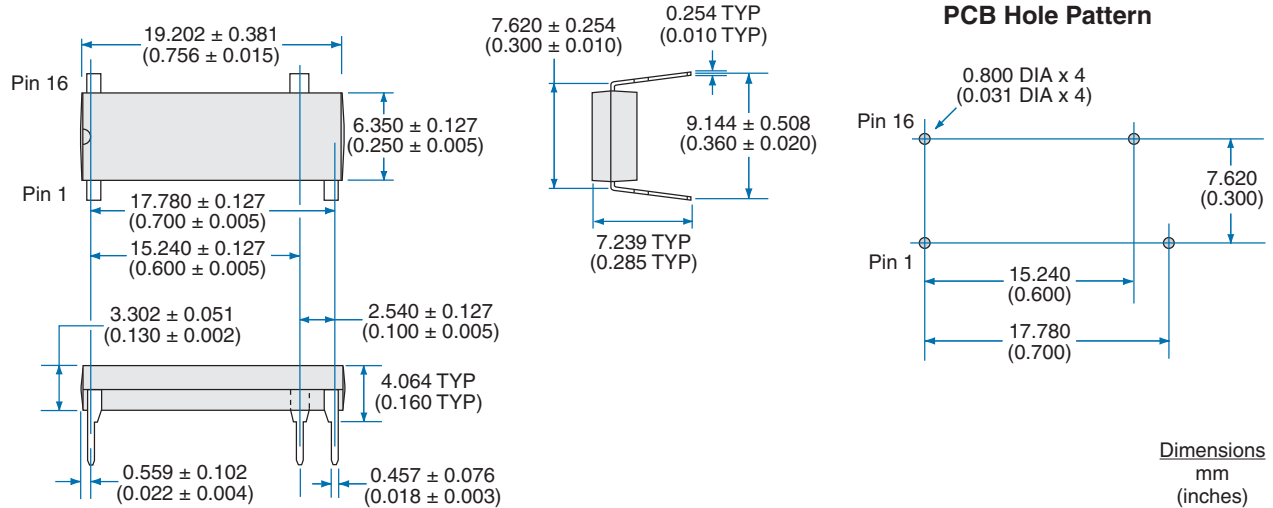

**For additional information please visit our website at: [www.clare.com](http://www.clare.com)**

Clare, Inc. makes no representations or warranties with respect to the accuracy or completeness of the contents of this publication and reserves the right to make changes to specifications and product descriptions at any time without notice. Neither circuit patent licenses nor indemnity are expressed or implied. Except as set forth in Clare's Standard Terms and Conditions of Sale, Clare, Inc. assumes no liability whatsoever, and disclaims any express or implied warranty, relating to its products including, but not limited to, the implied warranty of merchantability, fitness for a particular purpose, or infringement of any intellectual property right.

The products described in this document are not designed, intended, authorized or warranted for use as components in systems intended for surgical implant into the body, or in other applications intended to support or sustain life, or where malfunction of Clare's product may result in direct physical harm, injury, or death to a person or severe property or environmental damage. Clare, Inc. reserves the right to discontinue or make changes to its products at any time without notice.