

# A Series 4 & 5 Tumbler 1-4 Pole Switchlocks



## Features/Benefits

- Multi-pole and multi-position
- Shorting and non-shorting contacts available
- Low level and power capability
- PCB mounting

## Typical Applications

- Security alarm systems
- Medical equipment
- Computer servers



## Specifications

**CONTACT RATING:** Q contact material: Switch-2.5 AMPS @ 125 V AC; 350 mA @ 125 V DC (UL/CSA). Carry-5 AMPS continuous. See page M-38 for additional ratings.

**ELECTRICAL LIFE:** 15,000 make-and-break cycles at full load up to 300,000 detent operations.

**CONTACT RESISTANCE:** Below 20 m Ω typ. initial @ 2-4 V DC, 100 mA, for both silver and gold plated contacts.

**INSULATION RESISTANCE:** 10<sup>9</sup> Ω min.

**DIELECTRIC STRENGTH:** 1,000 Vrms min. @ sea level.

**OPERATING TEMPERATURE:** -30°C to 85°C.

**INDEXING:** 30°: 2-4 positions, 45° or 90°: 2-3 positions.

**STATIC RESISTANCE:** Anti-static models exceed 20 KV DC static resistance @ sea level, lock body to terminals.

## Materials

**LOCK:** Zinc alloy with stainless steel facing.

**KEYS:** Two nickel plated brass keys with code number.

**SWITCH HOUSING:** Glass filled 6/6 nylon (UL 94V-0).

**MOVABLE CONTACT:** Q contact material: Coin silver, silver plated. See page L-38 for additional contact materials.

**STATIONARY CONTACTS & TERMINALS:** Q contact material: Brass, silver plated. See page L-38 for additional contact materials.

**MOUNTING NUT:** Zinc alloy.

**DRESS NUT:** Brass, nickel plated.

**LOCKING RING:** 6/6 nylon (UL 94V-2).

**TERMINAL SEAL:** Epoxy.

**NOTE:** Any models supplied with Q or B contact material are RoHS compliant.

**NOTE:** Specifications and materials listed above are for switchlocks with standard options. For information on specific and custom switchlocks, consult Customer Service Center.

## Build-A-Switch

To order, simply select desired option from each category and place in the appropriate box. Available options are shown and described on pages L-35 through L-38. For additional options not shown in catalog, consult Customer Service Center.

### Switch and lock Function

- A21613** DP, 30°, keypull pos. 1
- A11413** SP, 90°, keypull pos. 1
- A31413** 3P, 90°, keypull pos. 1
- A3141U** 3P, 90°, keypull pos. 1 & 2
- A11513** SP, 45°, keypull pos. 1
- A31513** 3P, 45°, keypull pos. 1
- A3151U** 3P, 45°, keypull pos. 1 & 3
- A21582** DP, 45°, keypull pos. 1
- A11613** SP, 30°, keypull p05. 1
- A1161U** SP, 30°, keypull pos. 1 & 4
- A12112** SP, 45°, keypull p05. 1
- A42112** 4P, 45°, keypull pos. 1

### Keying

- 2** Two nickel plated brass keys

### Lock Type

- A** 4 Tumbler lock
- G** 5 Tumbler lock with anti-static switch
- Y** 4 Tumbler lock with anti-static switch

### Lock Finish

- 2** Stainless steel facing
- 1** Nickel plated with removable dress nut
- 8** Gloss black facing

### Shorting/Non-Shorting

- N** Non-shorting contacts
- S** Shorting contacts

### Terminations

- Z** Solder lug
- C** PC Thru-hole

### Mounting/Lock Style

- N** With nut
- R** With removable dress nut

### Contact Material

- Q** Silver
- B** Gold

### Seal

- NONE** No seal
- E** Epoxy seal



Switchlock



Dimensions are shown: Inch (mm)  
Specifications and dimensions subject to change

# A Series 4 & 5 Tumbler 1-4 Pole Switchlocks

## SWITCH AND LOCK FUNCTION

NO. POLES	MODEL NO.	CONNECTED TERMINALS				KEY PULL POSITIONS	LOCK CONFIGURATION	INDEXING
		POS. 1	POS. 2	POS. 3	POS. 4			
SP 3P	<b>A11413 *</b> <b>A31413</b>	A-1 A-1, B-5, C-9	A-4 A-4, B-8, C-12			Position 1		90°
3P	<b>A3141U</b>	A-1, B-5, C-9	A-4, B-8, C-12			Positions 1 & 2		
SP 3P	<b>A11513 *</b> <b>A31513</b>	A-1 A-1, B-5, C-9	A-2 A-2, B-6, C-10	A-4 A-4, B-8, C-12		Position 1		45°
3P	<b>A3151U</b>	A-1, B-5, C-9	A-2, B-6, C-10	A-4, B-8, C-12		Positions 1 & 3		
DP	<b>A21582</b>	A-4, C-10	A-5, C-11	A-2, C-8		Position 1		
SP DP	<b>A11613 *</b> <b>A21613</b>	A-1 A-1, C-7	A-2 A-2, C-8	A-3 A-3, C-9	A-4 A-4, C-10	Position 1		30°
SP	<b>A1161U *</b>	A-1	A-2	A-3	A-4	Positions 1 & 4		
SP 4P	<b>A12112 *</b> <b>A42112</b>	A-1 A-1, B-4, C-7, D-10	A-2 A-2, B-5, C-8, D-11			Position 1		45°

### LEGEND

- = Detent Positions (30°, 45° or 90°)
- ⊙ = Key pull possible in these positions.
- = Stop Positions

**\*NOTE:** Switchlock models A114XX, A115XX, A116XX and A12112 with 'C' terminations have additional terminal no. 8 as switch support only. This terminal is not connected electrically inside switch.

All models with all options when ordered with 'Q' contact material.

AX14 models not available with 'S' shorting contacts.

### TERMINAL NUMBERS



4P MODEL



3P MODEL

SP MODEL (omit terminals B, C & D)  
DP MODEL (omit terminals B & D)

Terminal numbers molded on housing bottom.

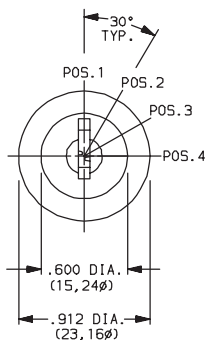

AX161X SWITCH FUNCTION SHOWN

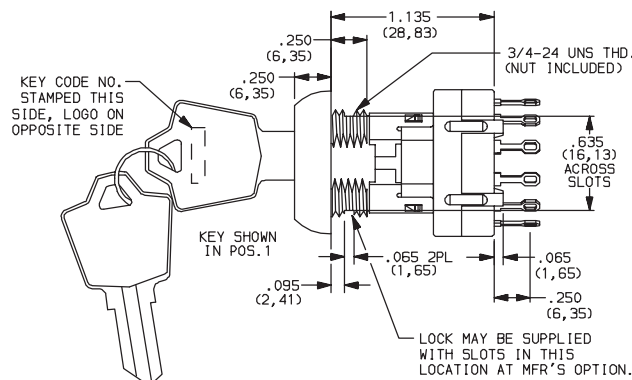

Part number shown: A116132Y2NZNQ

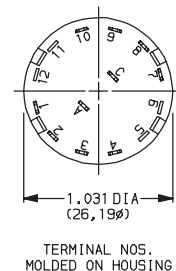

TERMINAL NOS. MOLDED ON HOUSING



Dimensions are shown: Inch (mm)  
Specifications and dimensions subject to change



# A Series 4 & 5 Tumbler 1-4 Pole Switchlocks

## KEYING

OPTION CODE	KEYING OPTIONS	CODE NO. ON KEY	CODE NO. ON LOCK
2	2 NICKEL PLATED BRASS KEYS	YES	NO

**NOTE:** All orders keyed alike, standard. For more than one key code, replacement keys, or other special features, consult Customer Service Center.

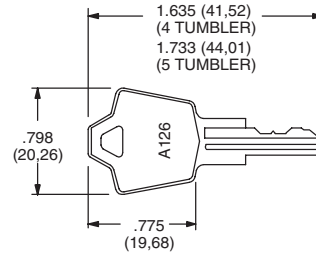

Key part number: 115140126

**NOTE:** Key head shape subject to change without notice.

## LOCK TYPE

**A** 4 TUMBLER LOCK WITH REMOVABLE DRESS NUT

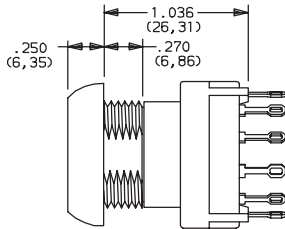

**G** 5 TUMBLER LOCK WITH ANTI-STATIC SWITCH

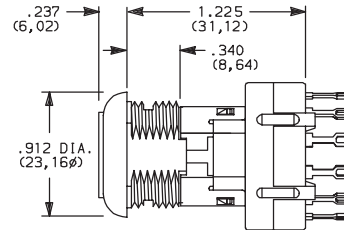

Not available with AX23 models.

**Y** 4 TUMBLER LOCK WITH ANTI-STATIC SWITCH

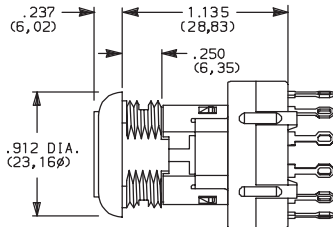

AVAILABLE OPTION COMBINATIONS		
LOCK TYPES	MOUNTING STYLES	
	N	R
G	•	
A		•
Y	•	

**NOTE:** For available option combinations, see page L-38.

## LOCK FINISH

**2** STAINLESS STEEL



**1** NICKEL



**8** GLOSS BLACK



AVAILABLE OPTION COMBINATIONS					
FINISH OPTIONS	LOCK TYPES			MOUNTING STYLES	
	G	A	Y	N	R
1		•			•
2	•		•	•	
8	•	•	•		•

**NOTE:** For available option combinations, see page M-38.

## SHORTING/NON-SHORTING

**N** NON-SHORTING CONTACTS (break-before-make)

**S** SHORTING CONTACTS (make-before-break)

Not available with AX14 models.



Third Angle Projection

Dimensions are shown: Inch (mm)  
Specifications and dimensions subject to change



Switchlock

# A Series 4 & 5 Tumbler 1-4 Pole Switchlocks

## TERMINATIONS

### Z SOLDER LUG

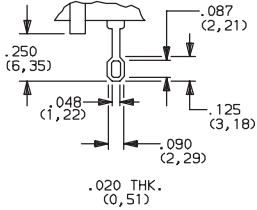

### C PC THRU-HOLE

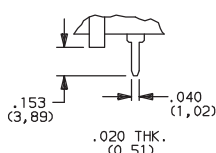

### PC MOUNTING

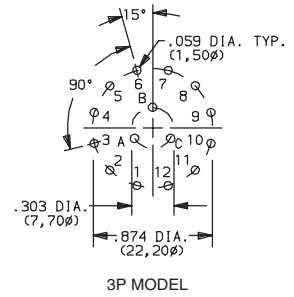
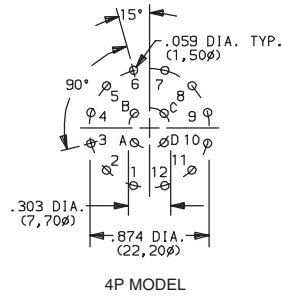

SP MODEL (omit terminals B, C, D)  
DP MODEL (omit terminals B & D)

## MOUNTING/LOCK STYLE

### N WITH NUT

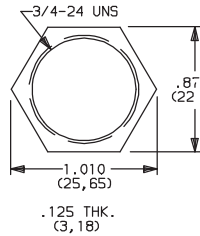

Nut part number: 175050700

### PANEL MOUNTING

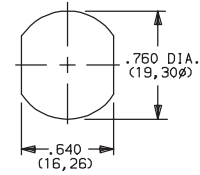

### R REMOVABLE DRESS NUT

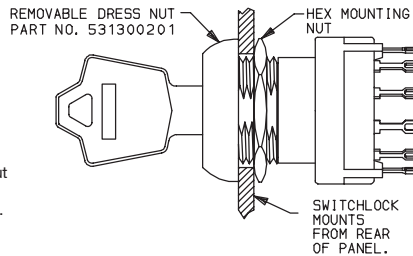
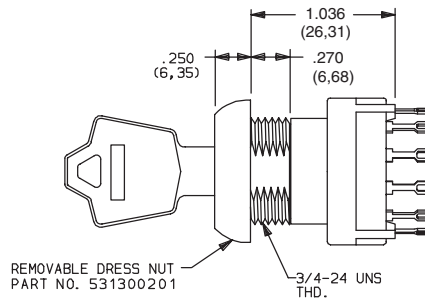
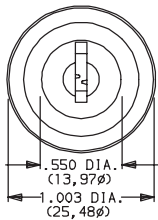

### PANEL MOUNTING

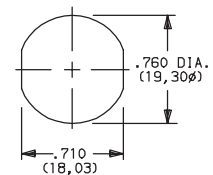

#### TYPICAL INSTALLATION

Install hex nut with enough clearance to allow for dress nut and panel. Place switch through cutout in rear of panel. Install and tighten dress nut by hand, then tighten hex nut. Always tighten assembly with back of panel hex nut to avoid damaging front of panel.



Third Angle  
Projection

Dimensions are shown: Inch (mm)  
Specifications and dimensions subject to change

# A Series 4 & 5 Tumbler 1-4 Pole Switchlocks

## MOUNTING/LOCK STYLE

### Mounting Information (All Models)

MOUNTING STYLES	PANEL THICKNESS	
	A & Y LOCK TYPES	G LOCK TYPES
N	.105 (2,67) max.	.195 (4,95) max.
R	.125 (3,18) max.	.215 (5,46) max.

AVAILABLE OPTION COMBINATIONS						
MOUNTING STYLES	LOCK FINISHES			LOCK TYPES		
	1	2	8	G	A	Y
N		•	•	•		•
R	•		•		•	

### Switch and Lock Assembly Instructions

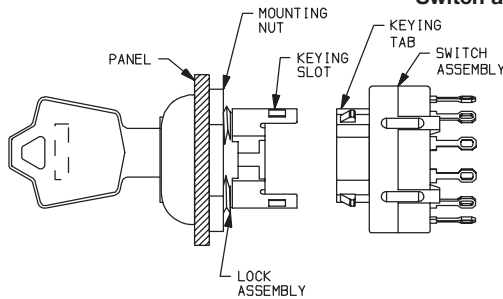

1. Place lock assembly in mounting hole on panel, secure with mounting nut.
2. Align keying tab on switch assembly with keying slot on lock assembly.
3. Snap assemblies together.
4. Switch installation is permanent. Switch cannot be removed from lock after assembly. Attempting to separate switch and lock may cause damage to switchlock.

## CONTACT MATERIAL

OPTION CODE	RoHS COMPLIANT*	RoHS COMPATIBLE*	CONTACT AND TERMINAL MATERIAL	RATING	
<b>Q</b>	YES	YES	SILVER <sup>2</sup>	POWER	SWITCH-2.5 AMPS @ 125 V AC; 350 mA @ 125 V DC (UL/CSA). CARRY-5 AMPS CONTINUOUS.
<b>B</b>	YES	YES	GOLD <sup>1</sup>	LOW LEVEL/DRY CIRCUIT	0.4 VA MAX. @ 20 V AC or DC MAX.

<sup>1</sup> MOVABLE CONTACT: Copper alloy, with gold plate over nickel plate.  
STATIONARY CONTACTS & TERMINALS: Brass, with gold plate over nickel plate.  
<sup>2</sup> MOVABLE CONTACT: Coin silver, silver plated.  
STATIONARY CONTACTS & TERMINALS: Brass, silver plated (standard with all termination options).

\* Note: See Technical Data section of this catalog for RoHS compliant and compatible definitions and specifications.

All models with all options when ordered with 'Q' contact material.

## SEAL

**NONE** NO SEAL

**E** EPOXY SEAL

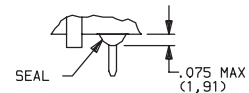

## AVAILABLE HARDWARE



Key Code: A126  
4 TUMBLER  
**PART NO. (ONE KEY)**  
**115140126**

**Material:** Brass  
**Finish:** Nickel plate

Key Code: D001  
5 TUMBLER  
**PART NO. (ONE KEY)**  
**115441001**

**Material:** Brass  
**Finish:** Nickel plate



Third Angle Projection

Dimensions are shown: Inch (mm)  
Specifications and dimensions subject to change



Switchlock