

MMQA5V6T1 Series

24 Watt Peak Power Zener Transient Voltage Suppressors

SC-59 Quad Common Anode for Zeners ESD Protection

These quad monolithic silicon voltage suppressors are designed for applications requiring transient voltage protection capability. They are intended for use in voltage and ESD sensitive equipment such as computers, printers, business machines, communication systems, medical equipment, and other applications. Their quad junction common anode design protects four separate lines using only one package. These devices are ideal for situations where board space is at a premium.

Specification Features:

- SC-59 Package Allows Four Separate Unidirectional Configurations
- Working Peak Reverse Voltage Range – 3.0 V to 2.5 V
- Standard Zener Breakdown Voltage Range – 5.6 V to 33 V
- Peak Power – Minimum 24 W @ 1 ms (Unidirectional), per Figure 5
- Peak Power – Minimum 150 W @ 20 μ s (Unidirectional), per Figure 6
- ESD Rating of Class 3 (> 16 KV) per Human Body Model
- Maximum Clamp Voltage @ Peak Pulse Current
- Package Designed for Optimal Automated Board Assembly
- Small Package Size for High Density Applications
- Low Leakage < 2.0 μ A

Mechanical Characteristics:

CASE: Void-free, transfer-molded, thermosetting plastic

FINISH: All external surfaces are corrosion resistant and leads are readily solderable

MAXIMUM CASE TEMPERATURE FOR SOLDERING PURPOSES:
260°C for 10 Seconds

MAXIMUM RATINGS

Rating	Symbol	Value	Unit
Peak Power Dissipation (Note 1) @ 1.0 ms @ $T_L \leq 25^\circ\text{C}$	P_{PK}	24	W
Peak Power Dissipation (Note 2) @ 20 μ s @ $T_L \leq 25^\circ\text{C}$	P_{PK}	150	W
Total Power Dissipation (Note 3) @ $T_A = 25^\circ\text{C}$ Derate Above 25°C	P_D	225 1.8	mW mW/°C
Thermal Resistance – Junction to Ambient	$R_{\theta JA}$	556	°C/W
Total Power Dissipation (Note 4) @ $T_A = 25^\circ\text{C}$ Derate Above 25°C	P_D	300 2.4	mW mW/°C
Thermal Resistance – Junction to Ambient	$R_{\theta JA}$	417	°C/W
Junction and Storage Temperature Range	T_J, T_{stg}	-55 to +150	°C

1. Nonrepetitive current pulse per Figure 5 and derated above $T_A = 25^\circ\text{C}$ per Figure 4
2. Nonrepetitive current pulse per Figure 6 and derated above $T_A = 25^\circ\text{C}$ per Figure 4
3. FR-5 board = 1.0 X 0.75 X 0.62 in.
4. Alumina substrate = 0.4 X 0.3 X 0.024 in., 99.5% alumina



ON Semiconductor®

<http://onsemi.com>

PIN ASSIGNMENT

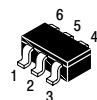

SC-59
CASE 318F
STYLE 1

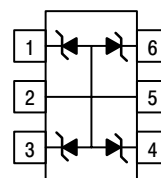

- PIN 1. CATHODE
2. ANODE
3. CATHODE
4. CATHODE
5. ANODE
6. CATHODE

MARKING DIAGRAM

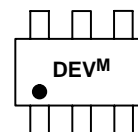

DEV = Device Code
(See Table Next Page)
M = Date Code

ORDERING INFORMATION

Device †	Package	Shipping
MMQAxxxT1	SC-59	3000/Tape & Reel
MMQAxxxT3*	SC-59	10,000/Tape & Reel

*MMQA13VT3 Not Available in 10,000/Tape & Reel

†The "T1" suffix refers to an 8 mm, 7 inch reel.
The "T3" suffix refers to an 8 mm, 13 inch reel.

MMQA5V6T1 Series

ELECTRICAL CHARACTERISTICS ($T_A = 25^\circ\text{C}$ unless otherwise noted, $V_F = 0.9\text{ V Max. @ } I_F$ (Note 5) = 10 mA)

Unidirectional (Circuit tied to Pins 1, 2 and 5; Pins 2, 3 and 5; or 2, 4 and 6; or Pins 2, 5 and 6)

Symbol	Parameter
I_{PP}	Maximum Reverse Peak Pulse Current
V_C	Clamping Voltage @ I_{PP}
V_{RWM}	Working Peak Reverse Voltage
I_R	Maximum Reverse Leakage Current @ V_{RWM}
Z_{ZT}	Maximum Zener Impedance @ I_{ZT}
V_{BR}	Breakdown Voltage @ I_T
I_T	Test Current
ΘV_{BR}	Maximum Temperature Coefficient of V_{BR}
I_F	Forward Current
V_F	Forward Voltage @ I_F

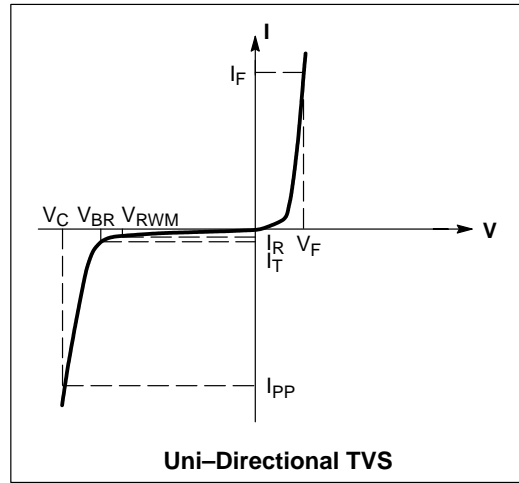

ELECTRICAL CHARACTERISTICS

Device	Device Marking	V_{RWM} Volts	I_R @ V_{RWM} nA	Breakdown Voltage				Z_{ZT} (Note 6) @ I_{ZT}		V_C @ I_{PP} (Note 7)		ΘV_{BR} mW/°C
				V_{BR} (Note 5) (Volts)			@ I_T mA	Ω	mA	V_C Volts	I_{PP} Amps	
				Min	Nom	Max						
MMQA5V6T1	5A6	3.0	2000	5.32	5.6	5.88	1.0	400	1.0	8.0	3.0	1.26
MMQA6V2T1,T3	6A2	4.0	700	5.89	6.2	6.51	1.0	300	1.0	9.0	2.66	10.6
MMQA6V8T1	6A8	4.3	500	6.46	6.8	7.14	1.0	300	1.0	9.8	2.45	10.9
MMQA12VT1	12A	9.1	75	11.4	12	12.6	1.0	80	1.0	17.3	1.39	14
MMQA13VT1,T3	13A	9.8	75	12.35	13	13.65	1.0	80	1.0	18.6	1.29	15
MMQA15VT1	15A	11	75	14.25	15	15.75	1.0	80	1.0	21.7	1.1	16
MMQA18VT1	18A	14	75	17.1	18	18.9	1.0	80	1.0	26	0.923	19
MMQA20VT1,T3*	20A	15	75	19.0	20	21.0	1.0	80	1.0	28.6	0.84	20.1
MMQA21VT1	21A	16	75	19.95	21	22.05	1.0	80	1.0	30.3	0.792	21
MMQA22VT1	22A	17	75	20.9	22	23.1	1.0	80	1.0	31.7	0.758	22
MMQA24VT1	24A	18	75	22.8	24	25.2	1.0	100	1.0	34.6	0.694	25
MMQA27VT1	27A	21	75	25.65	27	28.35	1.0	125	1.0	39.0	0.615	28
MMQA30VT1	30A	23	75	28.5	30	31.5	1.0	150	1.0	43.3	0.554	32
MMQA33VT1	33A	25	75	31.35	33	34.65	1.0	200	1.0	48.6	0.504	37

5. V_{BR} measured at pulse test current I_T at an ambient temperature of 25°C

6. Z_{ZT} is measured by dividing the AC voltage drop across the device by the AC current supplied. The specified limits are $I_{Z(ac)} = 0.1 I_{Z(dc)}$ with the AC frequency = 1.0 kHz

7. Surge current waveform per Figure 5 and derate per Figure 4

*Not Available in the 10,000/Tape & Reel.

MMQA5V6T1 Series

TYPICAL CHARACTERISTICS

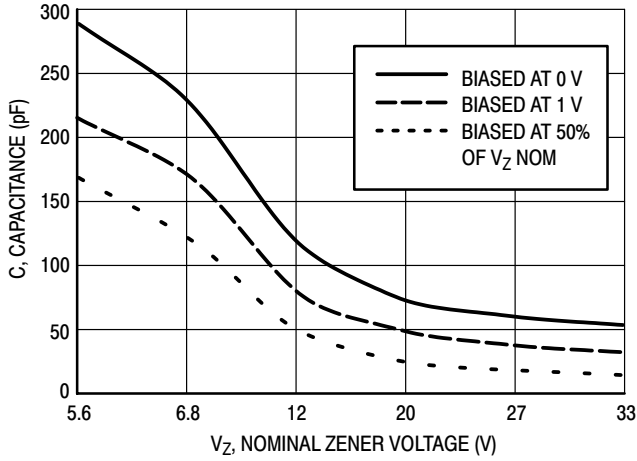

Figure 1. Typical Capacitance

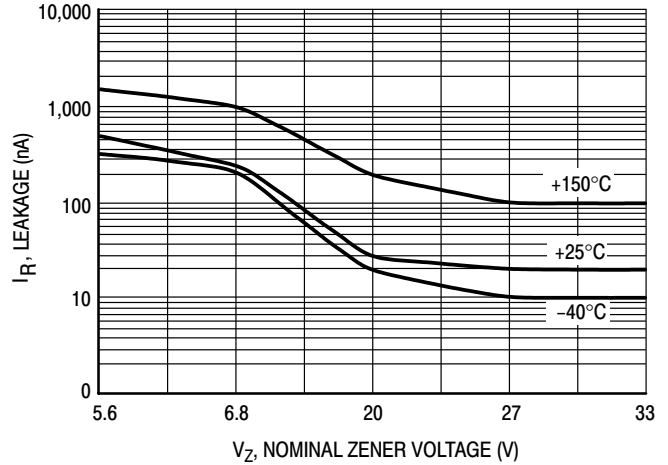

Figure 2. Typical Leakage Current

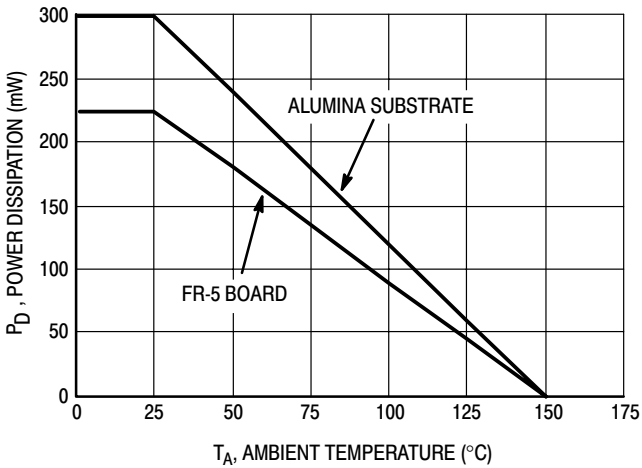

Figure 3. Steady State Power Derating Curve

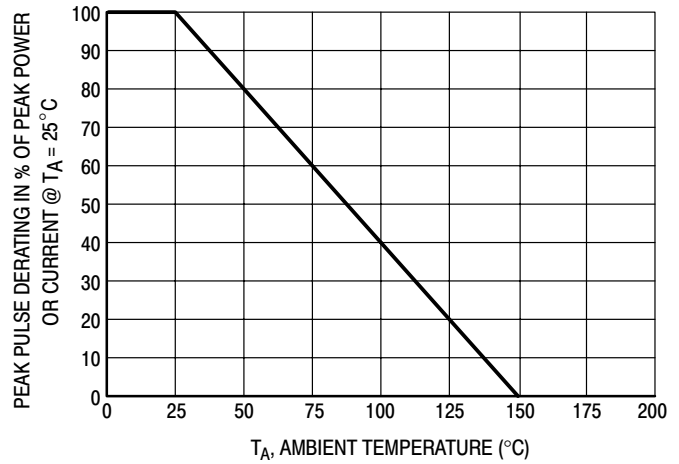

Figure 4. Pulse Derating Curve

MMQA5V6T1 Series

TYPICAL CHARACTERISTICS

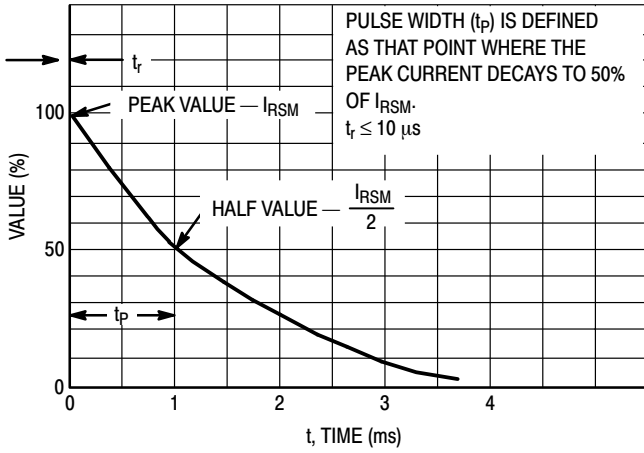

Figure 5. 10 × 1000 μs Pulse Waveform

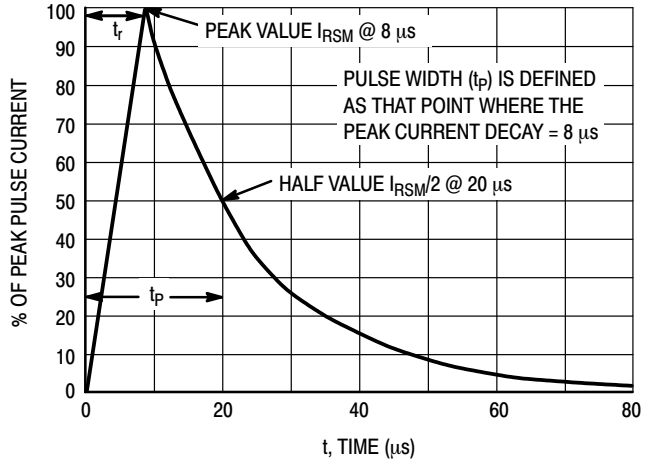

Figure 6. 8 × 20 μs Pulse Waveform

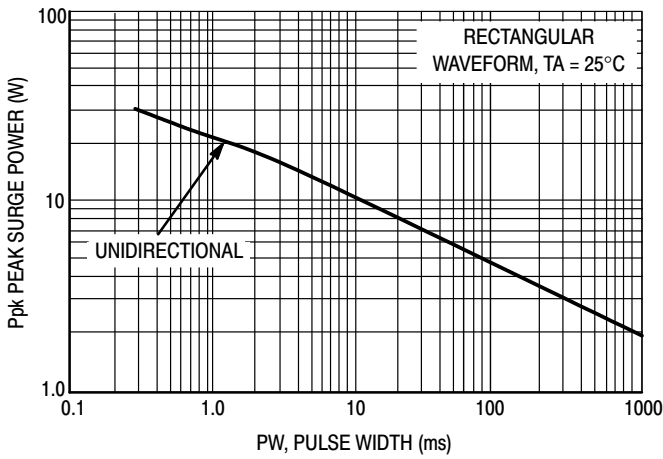

Figure 7. Maximum Non-Repetitive Surge Power, Ppk versus PW

Power is defined as $V_{RSM} \times I_Z(pk)$ where V_{RSM} is the clamping voltage at $I_Z(pk)$.

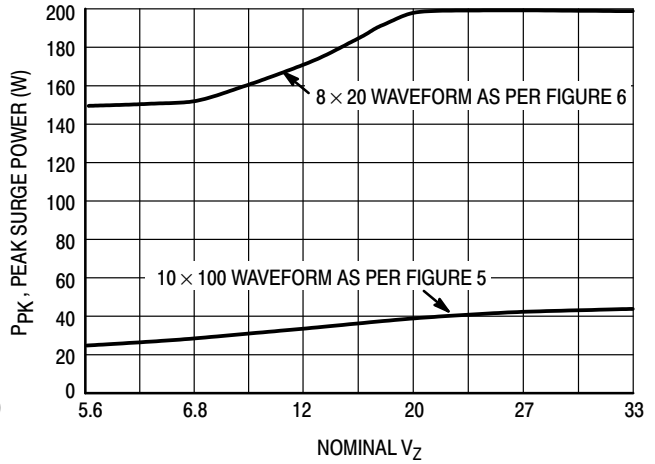

Figure 8. Typical Maximum Non-Repetitive Surge Power, Ppk versus V_Z

MMQA5V6T1 Series

TYPICAL COMMON ANODE APPLICATIONS

A quad junction common anode design in a SC-74 package protects four separate lines using only one package. This adds flexibility and creativity to PCB design especially

when board space is at a premium. A simplified example of MMQA Series Device applications is illustrated below.

Computer Interface Protection

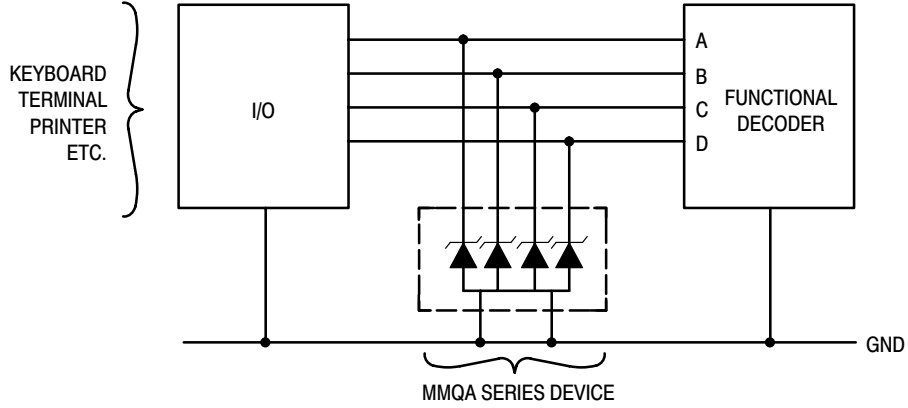

Microprocessor Protection

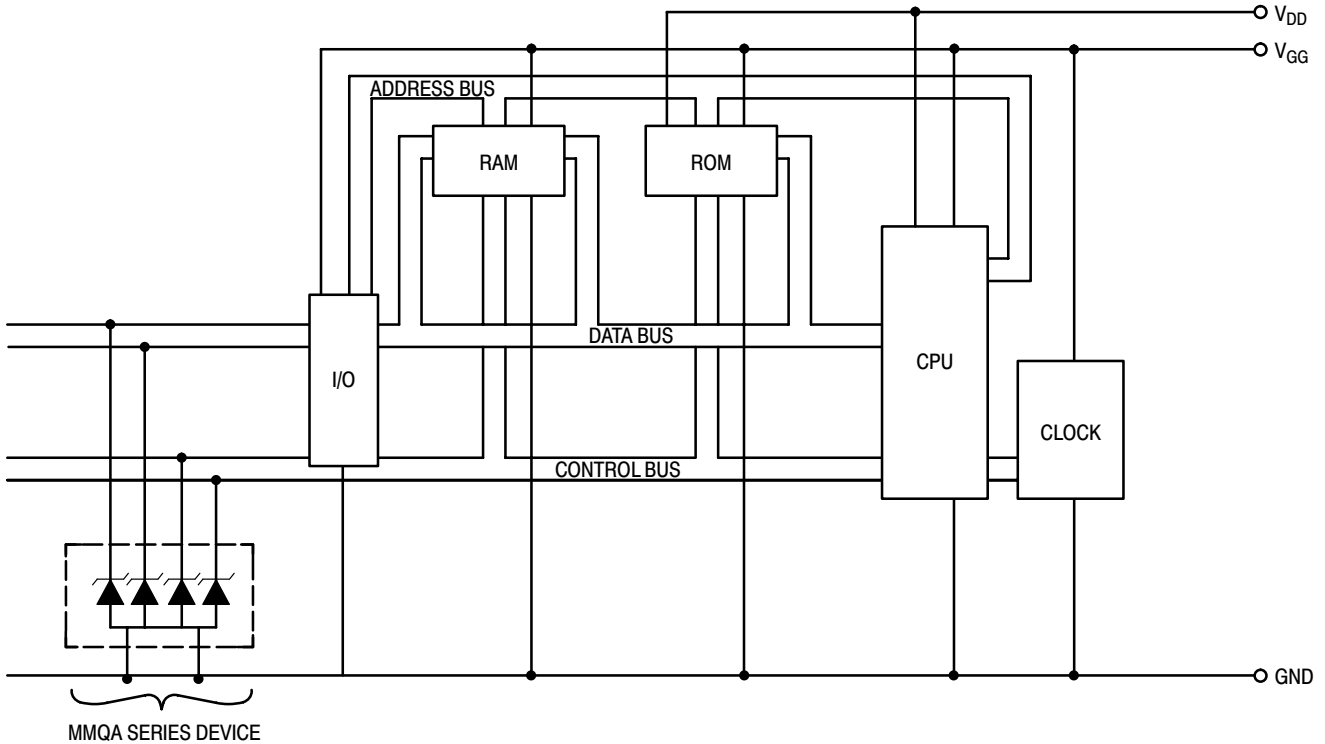

INFORMATION FOR USING THE SC-59 6 LEAD SURFACE MOUNT PACKAGE

MINIMUM RECOMMENDED FOOTPRINT FOR SURFACE MOUNTED APPLICATIONS

Surface mount board layout is a critical portion of the total design. The footprint for the semiconductor packages must be the correct size to ensure proper solder connection

interface between the board and the package. With the correct pad geometry, the packages will self-align when subjected to a solder reflow process.

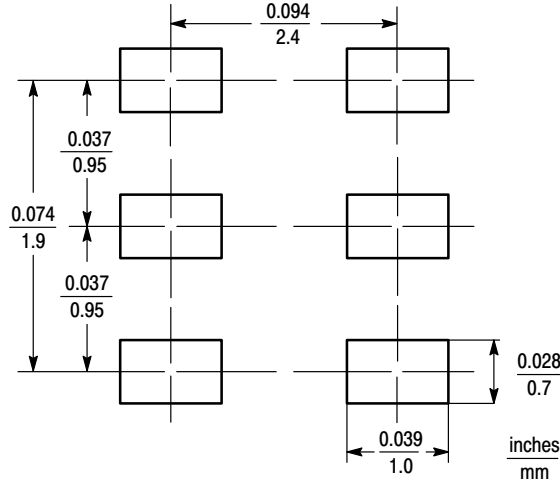

SC-59 6 LEAD

SC-59 6 LEAD POWER DISSIPATION

The power dissipation of the SC-59 6 Lead is a function of the pad size. This can vary from the minimum pad size for soldering to a pad size given for maximum power dissipation. Power dissipation for a surface mount device is determined by $T_{J(max)}$, the maximum rated junction temperature of the die, $R_{\theta JA}$, the thermal resistance from the device junction to ambient, and the operating temperature, T_A . Using the values provided on the data sheet for the SC-59 6 Lead package, P_D can be calculated as follows:

$$P_D = \frac{T_{J(max)} - T_A}{R_{\theta JA}}$$

The values for the equation are found in the maximum ratings table on the data sheet. Substituting these values into the equation for an ambient temperature T_A of 25°C,

one can calculate the power dissipation of the device which in this case is 225 milliwatts.

$$P_D = \frac{150^\circ\text{C} - 25^\circ\text{C}}{556^\circ\text{C/W}} = 225 \text{ milliwatts}$$

The 556°C/W for the SC-59 6 Lead package assumes the use of the recommended footprint on a glass epoxy printed circuit board to achieve a power dissipation of 225 milliwatts. There are other alternatives to achieving higher power dissipation from the SC-59 6 Lead package. Another alternative would be to use a ceramic substrate or an aluminum core board such as Thermal Clad®. Using a board material such as Thermal Clad, an aluminum core board, the power dissipation can be doubled using the same footprint.

SOLDER STENCIL GUIDELINES

Prior to placing surface mount components onto a printed circuit board, solder paste must be applied to the pads. Solder stencils are used to screen the optimum amount. These stencils are typically 0.008 inches thick and may be made of brass or stainless steel. For packages such as the

SC-59, SC-59 6 Lead, SC-70/SOT-323, SOD-123, SOT-23, SOT-143, SOT-223, SO-8, SO-14, SO-16, and SMB/SMC diode packages, the stencil opening should be the same as the pad size or a 1:1 registration.

MMQA5V6T1 Series

SOLDERING PRECAUTIONS

The melting temperature of solder is higher than the rated temperature of the device. When the entire device is heated to a high temperature, failure to complete soldering within a short time could result in device failure. Therefore, the following items should always be observed in order to minimize the thermal stress to which the devices are subjected.

- Always preheat the device.
- The delta temperature between the preheat and soldering should be 100°C or less.*
- When preheating and soldering, the temperature of the leads and the case must not exceed the maximum temperature ratings as shown on the data sheet. When using infrared heating with the reflow soldering method, the difference should be a maximum of 10°C.

- The soldering temperature and time should not exceed 260°C for more than 10 seconds.
- When shifting from preheating to soldering, the maximum temperature gradient should be 5°C or less.
- After soldering has been completed, the device should be allowed to cool naturally for at least three minutes. Gradual cooling should be used since the use of forced cooling will increase the temperature gradient and will result in latent failure due to mechanical stress.
- Mechanical stress or shock should not be applied during cooling.

* * Soldering a device without preheating can cause excessive thermal shock and stress which can result in damage to the device.

TYPICAL SOLDER HEATING PROFILE

For any given circuit board, there will be a group of control settings that will give the desired heat pattern. The operator must set temperatures for several heating zones and a figure for belt speed. Taken together, these control settings make up a heating “profile” for that particular circuit board. On machines controlled by a computer, the computer remembers these profiles from one operating session to the next. Figure 9 shows a typical heating profile for use when soldering a surface mount device to a printed circuit board. This profile will vary among soldering systems, but it is a good starting point. Factors that can affect the profile include the type of soldering system in use, density and types of components on the board, type of solder used, and the type of board or substrate material being used. This profile shows temperature versus time.

The line on the graph shows the actual temperature that might be experienced on the surface of a test board at or near a central solder joint. The two profiles are based on a high density and a low density board. The Vitronics SMD310 convection/infrared reflow soldering system was used to generate this profile. The type of solder used was 62/36/2 Tin Lead Silver with a melting point between 177–189°C. When this type of furnace is used for solder reflow work, the circuit boards and solder joints tend to heat first. The components on the board are then heated by conduction. The circuit board, because it has a large surface area, absorbs the thermal energy more efficiently, then distributes this energy to the components. Because of this effect, the main body of a component may be up to 30 degrees cooler than the adjacent solder joints.

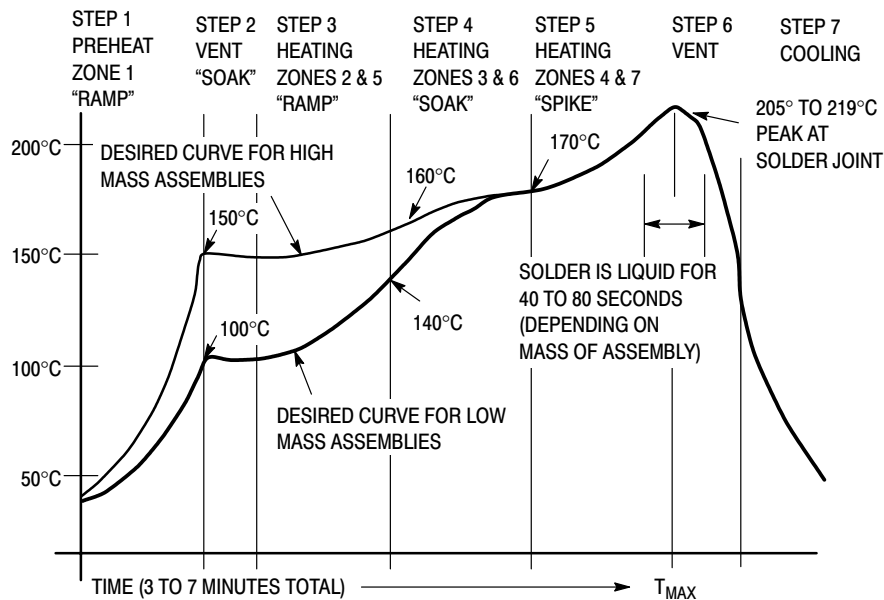

Figure 9. Typical Solder Heating Profile

MMQA5V6T1 Series

OUTLINE DIMENSIONS

Transient Voltage Suppressors – Surface Mounted

24 Watt Peak Power

SC-59
CASE 318F-03
ISSUE F

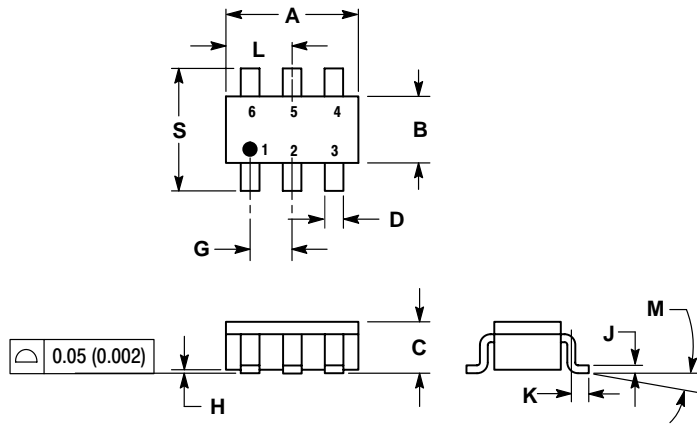

NOTES:

1. DIMENSIONING AND TOLERANCING PER ANSI Y14.5M, 1982.
2. CONTROLLING DIMENSION: INCH.
3. MAXIMUM LEAD THICKNESS INCLUDES LEAD FINISH THICKNESS. MINIMUM LEAD THICKNESS IS THE MINIMUM THICKNESS OF BASE MATERIAL.
4. 318F-01 AND -02 OBSOLETE. NEW STANDARD 318F-03.

DIM	INCHES		MILLIMETERS	
	MIN	MAX	MIN	MAX
A	0.1142	0.1220	2.90	3.10
B	0.0512	0.0669	1.30	1.70
C	0.0354	0.0433	0.90	1.10
D	0.0098	0.0197	0.25	0.50
G	0.0335	0.0413	0.85	1.05
H	0.0005	0.0040	0.013	0.100
J	0.0040	0.0102	0.10	0.26
K	0.0079	0.0236	0.20	0.60
L	0.0493	0.0649	1.25	1.65
M	0°	10°	0°	10°
S	0.0985	0.1181	2.50	3.00

STYLE 1:

1. CATHODE
2. ANODE
3. CATHODE
4. CATHODE
5. ANODE
6. CATHODE

Thermal Clad is a registered trademark of the Bergquist Company.

ON Semiconductor and  are registered trademarks of Semiconductor Components Industries, LLC (SCILLC). SCILLC reserves the right to make changes without further notice to any products herein. SCILLC makes no warranty, representation or guarantee regarding the suitability of its products for any particular purpose, nor does SCILLC assume any liability arising out of the application or use of any product or circuit, and specifically disclaims any and all liability, including without limitation special, consequential or incidental damages. "Typical" parameters which may be provided in SCILLC data sheets and/or specifications can and do vary in different applications and actual performance may vary over time. All operating parameters, including "Typicals" must be validated for each customer application by customer's technical experts. SCILLC does not convey any license under its patent rights nor the rights of others. SCILLC products are not designed, intended, or authorized for use as components in systems intended for surgical implant into the body, or other applications intended to support or sustain life, or for any other application in which the failure of the SCILLC product could create a situation where personal injury or death may occur. Should Buyer purchase or use SCILLC products for any such unintended or unauthorized application, Buyer shall indemnify and hold SCILLC and its officers, employees, subsidiaries, affiliates, and distributors harmless against all claims, costs, damages, and expenses, and reasonable attorney fees arising out of, directly or indirectly, any claim of personal injury or death associated with such unintended or unauthorized use, even if such claim alleges that SCILLC was negligent regarding the design or manufacture of the part. SCILLC is an Equal Opportunity/Affirmative Action Employer.

PUBLICATION ORDERING INFORMATION

Literature Fulfillment:

Literature Distribution Center for ON Semiconductor
P.O. Box 5163, Denver, Colorado 80217 USA
Phone: 303-675-2175 or 800-344-3860 Toll Free USA/Canada
Fax: 303-675-2176 or 800-344-3867 Toll Free USA/Canada
Email: ONlit@hibbertco.com

N. American Technical Support: 800-282-9855 Toll Free USA/Canada

JAPAN: ON Semiconductor, Japan Customer Focus Center
4-32-1 Nishi-Gotanda, Shinagawa-ku, Tokyo, Japan 141-0031
Phone: 81-3-5740-2700
Email: r14525@onsemi.com

ON Semiconductor Website: <http://onsemi.com>

For additional information, please contact your local Sales Representative.