

FlipKY[®], Chip Scale Package Schottky Barrier Rectifier, 0.5 A

 FlipKY[®]

FEATURES

- Ultra low V_F to footprint area
- Very low profile (< 0.6 mm)
- Low thermal resistance
- Supplied tested and on tape and reel
- Compliant to RoHS Directive 2002/95/EC

RoHS
COMPLIANT

APPLICATIONS

- Reverse polarity protection
- Current steering
- Freewheeling
- Flyback
- Oring

DESCRIPTION

Vishay's FlipKY[®] product family utilizes wafer level chip scale packaging to deliver Schottky diodes with the lowest V_F to PCB footprint area in industry. The three pad 0.9 mm x 1.2 mm devices can deliver up to 0.5 A and occupy only 1.08 mm² of board space. The anode and cathode connections are made through solder bump pads on one side of the silicon enabling designers to strategically place the diodes on the PCB. This design not only minimizes board space but also reduces thermal resistance and inductance, which can improve overall circuit efficiency.

Typical applications include hand-held, portable equipment such as cell phones, MP3 players, bluetooth, GPS, PDAs, and portable hard disk drives where space savings and performance are crucial.

PRODUCT SUMMARY	
$I_{F(AV)}$	0.5 A
V_R	40 V
V_F at I_F	0.42 V
I_{RM} max. at 25 °C	10 μ A
I_{RM} max. at 125 °C	2 mA
T_J max.	150 °C
E_{AS}	5 mJ

MAJOR RATINGS AND CHARACTERISTICS			
SYMBOL	CHARACTERISTICS	MAX.	UNITS
V_{RRM}		40	V
$I_{F(AV)}$	Rectangular waveform	0.5	A
I_{FSM}		190	
V_F	0.5 A_{pk} , $T_J = 125$ °C	0.42	V
T_J		- 55 to 150	°C

VOLTAGE RATINGS			
PARAMETER	SYMBOL	VS-FCSP05H40TR	UNITS
Maximum DC reverse voltage	V_R	40	V
Maximum working peak reverse voltage	V_{RWM}		



ABSOLUTE MAXIMUM RATINGS					
PARAMETER	SYMBOL	TEST CONDITIONS		VALUES	UNITS
Maximum average forward current	$I_{F(AV)}$	50 % duty cycle at $T_{PCB} = 114\text{ }^{\circ}\text{C}$, rectangular waveform		0.5	A
Maximum peak one cycle non-repetitive surge current at $25\text{ }^{\circ}\text{C}$	I_{FSM}	5 μs sine or 3 μs rect. pulse	Following any rated load condition and with rated V_{RRM} applied	190	
		10 ms sine or 6 ms rect. pulse		10	
Non-repetitive avalanche energy	E_{AS}	$T_J = 25\text{ }^{\circ}\text{C}$, $I_{AS} = 2.0\text{ A}$, $L = 5.0\text{ mH}$		5	mJ
Repetitive avalanche current	I_{AR}	Current decaying linearly to zero in 1 μs Frequency limited by T_J maximum $V_A = 1.5 \times V_R$ typical		0.5	A

ELECTRICAL SPECIFICATIONS ($T_J = 25\text{ }^{\circ}\text{C}$ unless otherwise specified)						
PARAMETER	SYMBOL	TEST CONDITIONS		TYP.	MAX.	UNITS
Maximum forward voltage drop See fig. 1	$V_{FM}^{(1)}$	0.5 A	$T_J = 25\text{ }^{\circ}\text{C}$	0.48	0.52	V
		1 A		0.54	0.58	
		0.5 A	$T_J = 125\text{ }^{\circ}\text{C}$	0.38	0.42	
		1 A		0.46	0.50	
Maximum reverse leakage current See fig. 2	$I_{RM}^{(1)}$	$T_J = 25\text{ }^{\circ}\text{C}$	$V_R = \text{Rated } V_R$	1	10	μA
			$V_R = 20\text{ V}$	0.2	0.5	
			$V_R = 10\text{ V}$	0.08	0.25	
			$V_R = 5\text{ V}$	0.05	0.15	
		$T_J = 125\text{ }^{\circ}\text{C}$	$V_R = \text{Rated } V_R$	0.5	2	mA
			$V_R = 20\text{ V}$	0.2	1	
			$V_R = 10\text{ V}$	0.15	0.8	
			$V_R = 5\text{ V}$	0.125	0.5	
Maximum junction capacitance	C_T	$V_R = 5\text{ V}_{DC}$ (test signal range 100 kHz to 1 MHz), $25\text{ }^{\circ}\text{C}$		-	90	pF
Maximum voltage rate of charge	dV/dt	Rated V_R		-	10 000	V/ μs

Note(1) Pulse width < 300 μs , duty cycle < 2 %

THERMAL - MECHANICAL SPECIFICATIONS					
PARAMETER	SYMBOL	TEST CONDITIONS		VALUES	UNITS
Maximum junction and storage temperature range	$T_J^{(1)}$, T_{Stg}			- 55 to 150	$^{\circ}\text{C}$
Typical thermal resistance, junction to PCB	$R_{thJL}^{(2)}$	DC operation		35	$^{\circ}\text{C/W}$
Maximum thermal resistance, junction to ambient	R_{thJA}			150	

Notes(1) $\frac{dP_{tot}}{dT_J} < \frac{1}{R_{thJA}}$ thermal runaway condition for a diode on its own heatsink

(2) Mounted on minimum footprint PCB

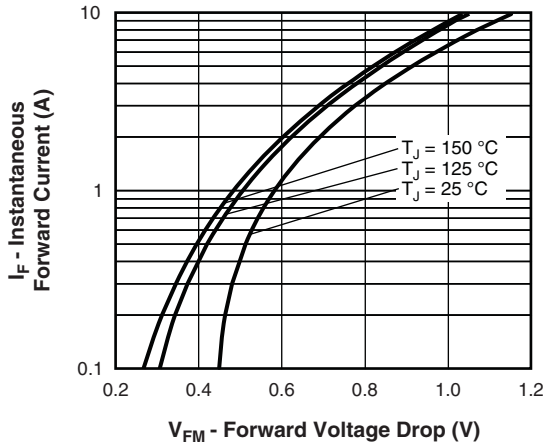

Fig. 1 - Maximum Forward Voltage Drop Characteristics (Per Leg)

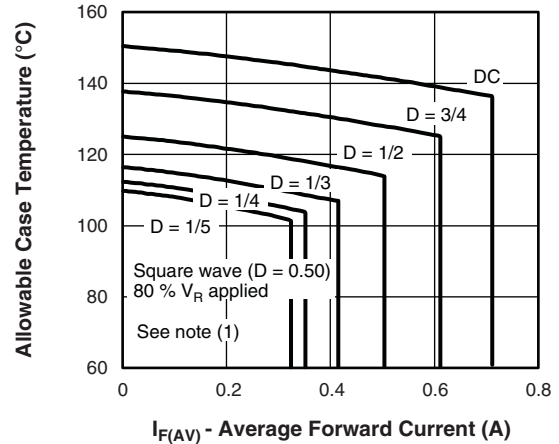

Fig. 4 - Maximum Allowable Case Temperature vs. Average Forward Current (Per Leg)

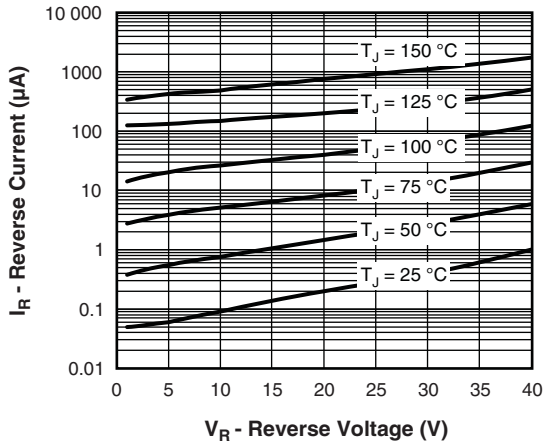

Fig. 2 - Typical Values of Reverse Current vs. Reverse Voltage (Per Leg)

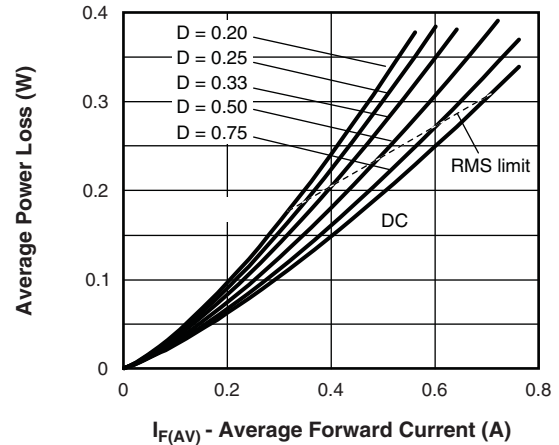

Fig. 5 - Forward Power Loss Characteristics (Per Leg)

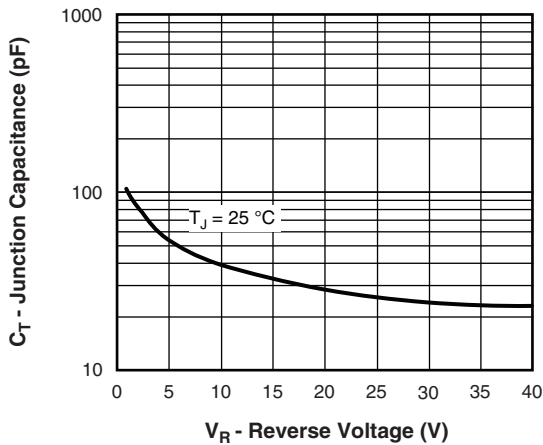

Fig. 3 - Typical Junction Capacitance vs. Reverse Voltage (Per Leg)

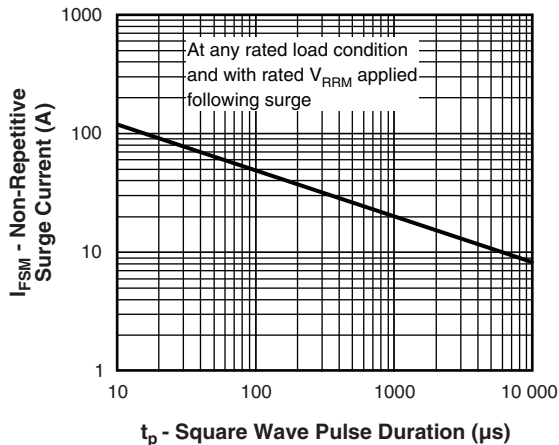

Fig. 6 - Maximum Non-Repetitive Surge Current (Per Leg)

Note

(1) Formula used: $T_C = T_J - (Pd + Pd_{REV}) \times R_{thJC}$;
Pd = Forward power loss = $I_{F(AV)} \times V_{FM}$ at $(I_{F(AV)}/D)$ (see fig. 6); Pd_{REV} = Inverse power loss = $V_{R1} \times I_R (1 - D)$; I_R at 80 % V_R applied

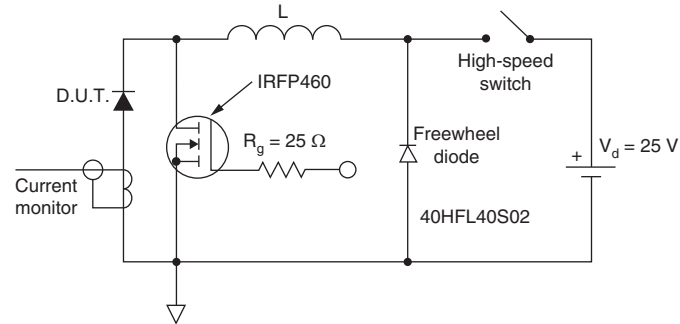

Fig. 7 - Unclamped Inductive Test Circuit

LINKS TO RELATED DOCUMENTS

LINKS TO RELATED DOCUMENTS	
Dimensions	www.vishay.com/doc?95049
Part marking information	www.vishay.com/doc?95060
Packaging information	www.vishay.com/doc?95062
SPIICE model	www.vishay.com/doc?95318

FlipKY® 0.5 A/0.75 A

DIMENSIONS in millimeters

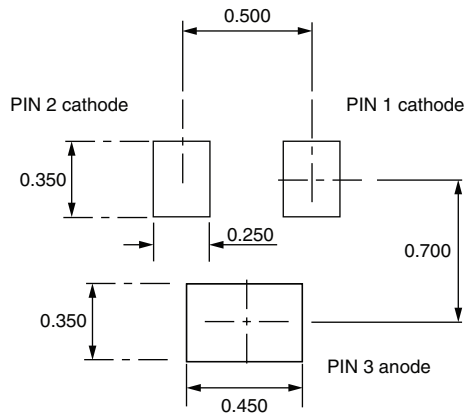
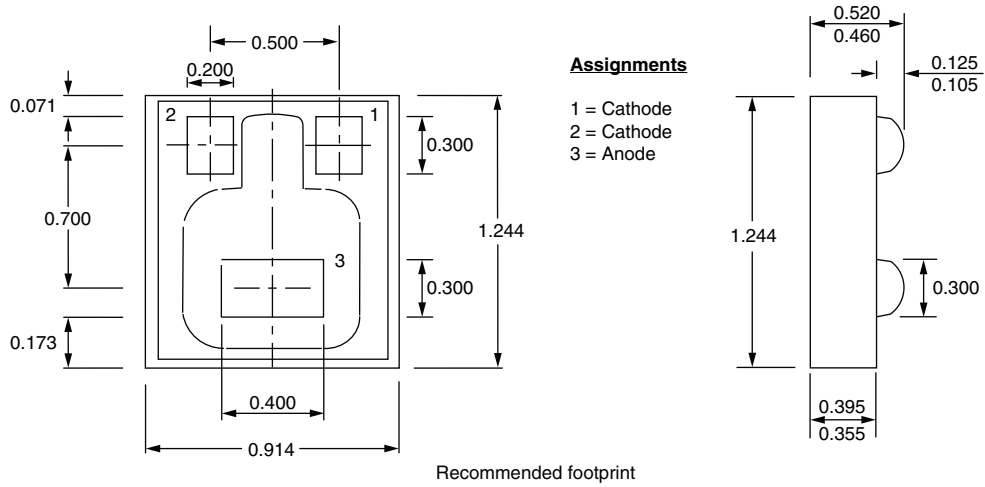

Notes

- Dimensioning and tolerancing per ASME Y14.5M-1994
- Controlling dimension: millimeter



Disclaimer

ALL PRODUCT, PRODUCT SPECIFICATIONS AND DATA ARE SUBJECT TO CHANGE WITHOUT NOTICE TO IMPROVE RELIABILITY, FUNCTION OR DESIGN OR OTHERWISE.

Vishay Intertechnology, Inc., its affiliates, agents, and employees, and all persons acting on its or their behalf (collectively, "Vishay"), disclaim any and all liability for any errors, inaccuracies or incompleteness contained in any datasheet or in any other disclosure relating to any product.

Vishay makes no warranty, representation or guarantee regarding the suitability of the products for any particular purpose or the continuing production of any product. To the maximum extent permitted by applicable law, Vishay disclaims (i) any and all liability arising out of the application or use of any product, (ii) any and all liability, including without limitation special, consequential or incidental damages, and (iii) any and all implied warranties, including warranties of fitness for particular purpose, non-infringement and merchantability.

Statements regarding the suitability of products for certain types of applications are based on Vishay's knowledge of typical requirements that are often placed on Vishay products in generic applications. Such statements are not binding statements about the suitability of products for a particular application. It is the customer's responsibility to validate that a particular product with the properties described in the product specification is suitable for use in a particular application. Parameters provided in datasheets and/or specifications may vary in different applications and performance may vary over time. All operating parameters, including typical parameters, must be validated for each customer application by the customer's technical experts. Product specifications do not expand or otherwise modify Vishay's terms and conditions of purchase, including but not limited to the warranty expressed therein.

Except as expressly indicated in writing, Vishay products are not designed for use in medical, life-saving, or life-sustaining applications or for any other application in which the failure of the Vishay product could result in personal injury or death. Customers using or selling Vishay products not expressly indicated for use in such applications do so at their own risk and agree to fully indemnify and hold Vishay and its distributors harmless from and against any and all claims, liabilities, expenses and damages arising or resulting in connection with such use or sale, including attorneys fees, even if such claim alleges that Vishay or its distributor was negligent regarding the design or manufacture of the part. Please contact authorized Vishay personnel to obtain written terms and conditions regarding products designed for such applications.

No license, express or implied, by estoppel or otherwise, to any intellectual property rights is granted by this document or by any conduct of Vishay. Product names and markings noted herein may be trademarks of their respective owners.