

New



RoHS compliant

FEATURES

1. Temperature detection achieved on a two dimensional area with 8 × 8 (64) pixels.
2. Digital output (temperature values can be output)
3. Miniature SMD package (reflow mounting supported)

TYPICAL APPLICATIONS

- High performance home appliance (Microwave oven and air conditioner)
- Energy savings in office (Air-conditioning and lighting controls)
- Digital signage
- Automatic door and elevator

ORDERING INFORMATION

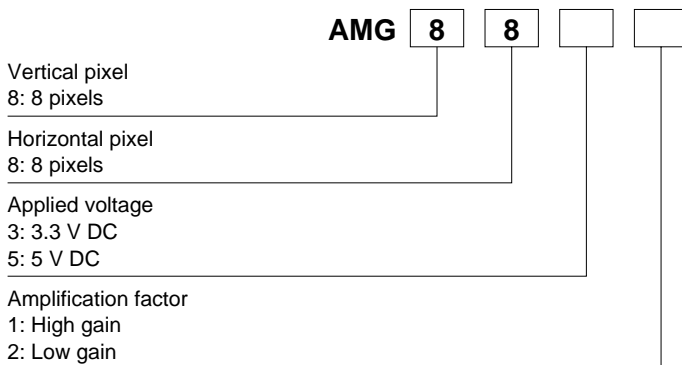

TYPES

Product name	Number of pixel	Operating voltage	Amplification factor	Part number
Infrared array sensor Grid-EYE	64 (Vertical 8 × Horizontal 8 Matrix)	3.3 V DC	High gain	AMG8831
			Low gain	AMG8832
		5.0 V DC	High gain	AMG8851
			Low gain	AMG8852

Tape and reel package: 1,000 pcs.

RATING

Item	Standard	
	High gain	Low gain
Applied voltage	3.3V±0.3V or 5.0V±0.5V	
Temperature range of measuring object	0°C to 80°C +32°F to +176°F	-20°C to 100°C -4°F to +212°F
Operating temperature range	0°C to 80°C +32°F to +176°F	-20°C to 80°C -4°F to +176°F
Storage temperature range	-20°C to 80°C -4°F to +176°F	-20°C to 80°C -4°F to +176°F

Infrared Array Sensor Grid-EYE (AMG88)

ABSOLUTE MAXIMUM RATINGS

Item	Standard	Terminal
Applied voltage	-0.3 to 6.5V	Vdd
Input voltage	-0.3 to Vdd + 0.3V	SCL, SDA, AD_SELECT
Output sink current	-10 to 10mA	INT, SDA
Static electricity (Human body model)	1kV	All terminals
Static electricity (Machine model)	200V	All terminals

CHARACTERISTICS

Item	Standard	
	High gain	Low gain
Temperature accuracy	Typical $\pm 2.5^{\circ}\text{C}$ $\pm 4.5^{\circ}\text{F}$	Typical $\pm 3.0^{\circ}\text{C}$ $\pm 5.4^{\circ}\text{F}$
Detection distance*1	Max. 5m 16.404ft	
Viewing angle	Typical 60°	
Optical axis gap	Within Typical $\pm 5.6^{\circ}$	
Current consumption	Typical 4.5mA (normal mode) Typical 0.2mA (sleep mode) Typical 0.8mA (stand-by mode)	
Setup time	Typical 50ms (Time to enable communication after setup) Typical 15s (Time to stabilize output after setup)	

Note: *1. To have more than 4°C 7.2°F of temperature difference from background
 Detection object size: $700 \times 250 \text{ mm}$ $27.559 \times 9.843 \text{ inch}$ (Assumable human body size)

FUNCTIONS

Item	Value
Number of pixel	64 (Vertical $8 \times$ Horizontal 8 Matrix)
External interface	I ² C (fast mode)
Frame rate	Typical 10 frames/sec or 1 frame/sec
Operating mode	Normal Sleep Stand-by (10 sec or 60 sec intermittence)
Output mode	Temperature output
Calculate mode	No moving average or Twice moving average
Temperature output resolution	0.25°C
Number of sensor address	2 (I ² C slave address)
Thermistor output temperature range	-20°C to 80°C -4°F to $+176^{\circ}\text{F}$
Thermistor output resolution	0.0625°C

INTERNAL CIRCUIT

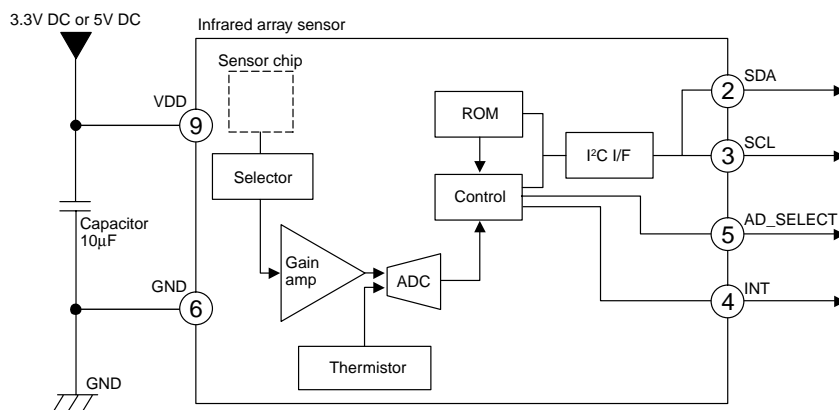

* INT terminal ④ normally has same voltage as VDD. When interrupting, same as GND (0V).

Infrared Array Sensor Grid-EYE (AMG88)

PIXEL ARRAY AND VIEWING FIELD

1. Pixel array

Pixel array from 1 to 64 is shown below.

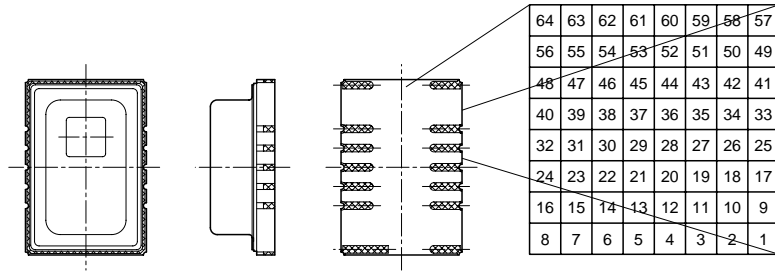

2. Viewing field

Sensor viewing field (typical) is shown below.

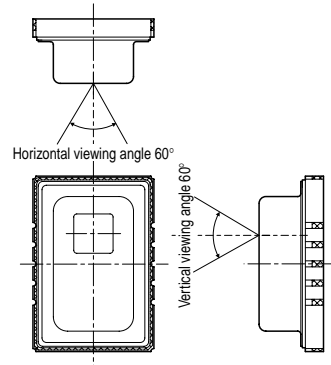

OPTICAL PROPERTIES

1. Each pixel's viewing central angle

Sensor's optical center (the origin of graph below) gap: within $\pm 5.6^\circ$ (Typical) (Both of horizontal and vertical directions)

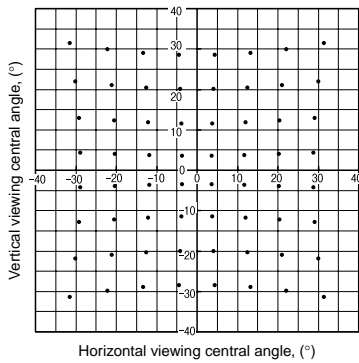

2. Each pixel's viewing angle (half angle)

Central 4 pixels (Pixel No. 28, 29, 36, 37) viewing angle (half angle): horizontal direction 7.5° (Typical) vertical direction 8° (Typical)

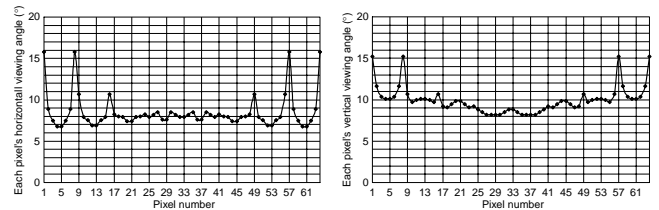

DIMENSIONS (mm inch)

The CAD data of the products with a **CAD Data** mark can be downloaded from: <http://industrial.panasonic.com/ac/e>

CAD Data External dimensions

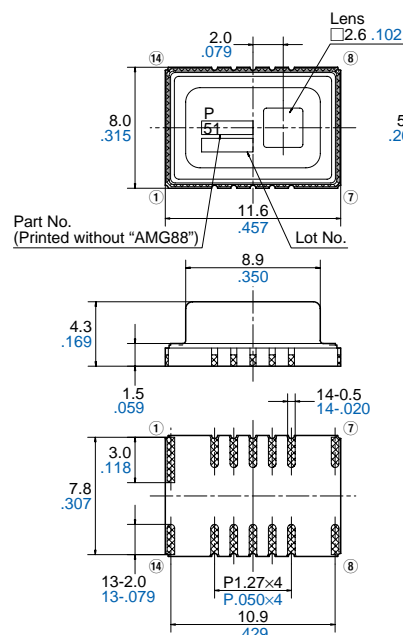

Terminal layout			
①	NC	⑧	NC
②	SDA	⑨	VDD
③	SCL	⑩	AVDD-PC
④	INT	⑪	NC
⑤	AD_SELECT	⑫	DVDD-PC
⑥	GND	⑬	VPP
⑦	NC	⑭	NC

Note: Leave terminal "NC (No. ①, ⑦, ⑧, ⑪ and ⑭)" unconnected. Make electrical potential of terminals ⑨ and ⑬ the same.

Recommended PC board pad

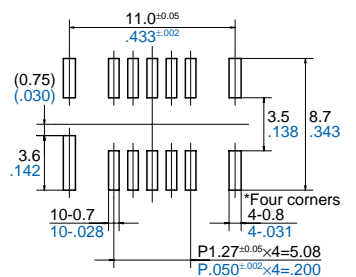

Tolerance outside of that indicated: $\pm 0.2 \pm 0.008$

Infrared Array Sensor Grid-EYE (AMG88)

RECOMMENDED EXTERNAL CIRCUIT

1. In case of setting I²C slave address of the sensor 1101000
* Connect terminal ⑤ (AD_SELECT) to GND.

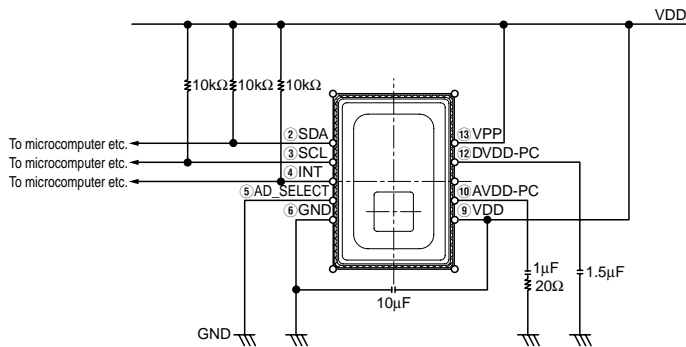

2. In case of setting I²C slave address of the sensor 1101001
* Connect terminal ⑤ (AD_SELECT) to VDD.

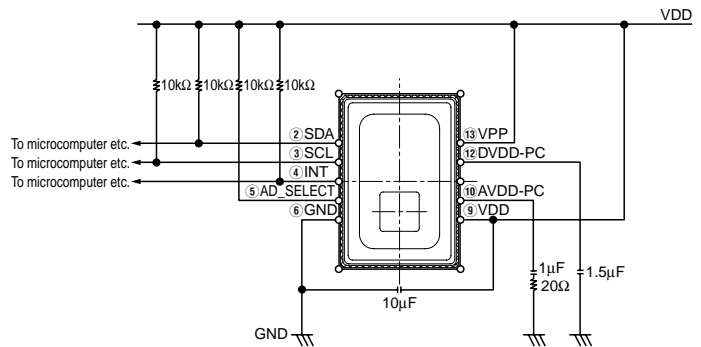

Recommended external circuit

This circuit is an example to drive infrared array sensor “Grid-EYE”, so that we will not take any responsibility of loss which is due to this circuit.

PACKING FORMAT (Tape and reel) (mm inch)

Tape dimensions

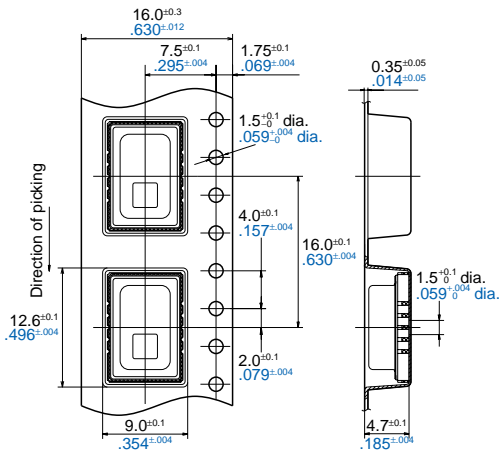

Dimensions of tape reel

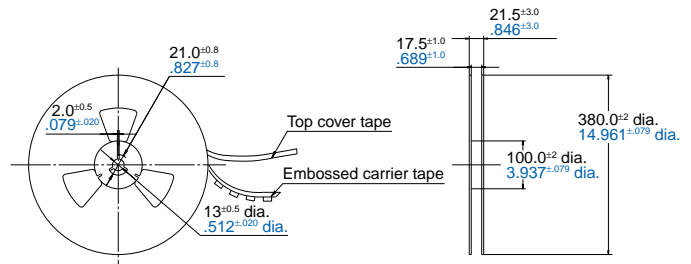

NOTES

1. Checkpoints relating to principle of operation

The Infrared array sensor is a thermobile-typed infrared sensor which detects quantity of infrared ray. Generally, temperature accuracy will be degraded in the following situations. Be sure to verify performance and reliability under actual conditions of use and make any necessary temperature corrections.

- There is a heat emitting body located close to where the sensor is mounted.
- A flow of warm or cold air is hitting the sensor.
- The temperature of the sensor is subject to sudden changes.
- When an object made of glass, acrylic or other subject which far infrared rays have difficult passing through is located between the sensor and what is to be detected.
- A substance (dirt or water droplets) that makes it difficult for far infrared rays to

pass through is attached to the sensor lens.

2. Ambient operating conditions

- 1) Temperature: Please refer to “RATING”.
- 2) Humidity: 15% to 85% R.H. (No freezing nor condensation at low temperature)
- 3) Atmospheric pressure: 86 to 106 kPa
- 4) Protect the sensor from impact and vibration, because these can cause damage that leads to malfunction and degraded performance. And avoid applying a load or impact since this will deform or scratch the lens, making proper operation impossible and causing a deterioration in its performance.
- 5) The sensors do not have a water-proof or dust-proof construction. Depending on the ambient operating conditions, some means of providing protection from water and dust and preventing the formation of

ice and condensation must be provided prior to using the sensors.

If condensation occurs, heat source detection response may become delayed by several seconds.

- 6) Please avoid using or storing the infrared array sensor in a place exposed to corrosive gases (such as the gases given off by organic solvents, sulfuric acid gas, hydrogen sulfides, etc.) which will adversely affect the performance of the infrared array sensor.
- 7) Since the internal circuitry may be destroyed if an external surge voltages is supplied, provide an element which will absorb the surges.
- 8) Malfunctioning may occur if the product is in the vicinity of electrical noise such as that from static electricity, lightning, a mobile phone, an amateur radio and a broadcasting station.

Infrared Array Sensor Grid-EYE (AMG88)

9) Although the ambient temperature (humidity) range is a temperature (humidity) range which can operate a sensor continuously, the humidity range changes with temperature. So please use it in the humidity range. And please avoid continuation use near a limit. This humidity range does not guarantee durability ability.

3. Other handling cautions

To assure reliability, check the sensor under actual loading conditions. Avoid any situation that may adversely affect its performance.

- 1) This sensor may malfunction if dropped on its own before it is installed. Do not use if this happens.
- 2) Caution is required because writing except for register and bit specified can be cause of malfunction and performance degradation. (Please consult us.)
- 3) Caution is required because differences in the temperature range and the method of connection can lead to breakdown.
- 4) If the sensor get high frequency vibration, it can be cause of breakdown. When the product get impulse like below, do not use it.

- Touch to a object made of metal
 - Touch of mutual sensors
- 5) Since static charge can damage the sensor, bear in mind the following handling precautions.
 - Plastic containers should not be used to store or transport the sensors since they readily become charged.
 - Please store or transport the sensor in an environment that hinders the occurrence of static electricity (for example, places with 45% to 60% humidity) and protect the product using electrically conductive packaging.
 - Implement static electricity prevention measures once the product packaging has been opened.
- (1) Any personnel handling the sensor should wear electrostatic clothing and be body grounded.
 - (2) Place an electrically conducting board on the work surface and ground any devices used such as measuring instruments and jigs.
 - (3) Use a soldering iron with a low leak current or else ground the tip.
 - (4) Make sure that customer equipment used for device assembly is grounded.
 - Use a regulated power supply as the power supply. Otherwise, power supply superimposed noise may cause the sensors to malfunction.

4. Ambient temperature (humidity) range

Although the ambient temperature (humidity) range is a temperature (humidity) range which can operate a sensor continuously, the humidity range changes with temperature. So please use it in the humidity range shown below. And please avoid continuation use near a limit. Generally under high temperature or high humidity, deterioration of electronic parts accelerates. To ensure reliability, please verify quality under conditions of actual use.

- This humidity range does not guarantee durability ability.

High gain type

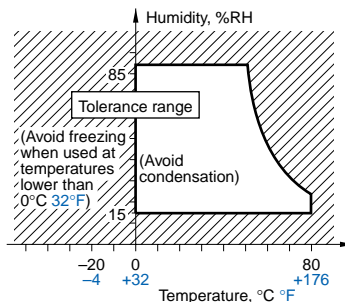

Low gain type

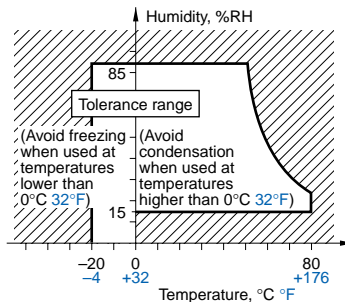

5. Mounting

Use lands on the PC boards to which the sensor can be securely fixed.

Recommended PC board is FR4 (thickness 1.6 mm .063 inch). As for mounting unrecommended PC board, please verify quality in advance.

- Malfunctioning may occur if much noise is present in the power supply used for this sensor. In order to prevent, in particular, superimposed noise, please install the recommended capacitor between the sensor input terminals (between VDD and GND) closest to the sensor (a position within 20 mm .787 inch of the PC pattern length). However, please reselect an ideal capacitor after performing tests on the actual equipment.
- Since the top surface (where the part number is visible) of the sensor is GND, please make sure that the metallic parts of other components do not come into contact.

6. Soldering

Due to the thermal capacity of the infrared array sensor is low, therefore, take steps to minimize the effects of external heat. Damage and changes to characteristics may occur due to heat deformation. Use a non-corrosive resin type of flux.

- 1) Manual soldering
 - Set the soldering tip from 350 to 400°C 662 to 752°F (30 to 60W), and solder within 3 seconds or less.
 - Please note that output may be changed if the load is applied to the terminals when the soldering.
 - Carefully clean the tip of soldering iron.

2) Reflow soldering
The recommended reflow temperature profile conditions are given below.

- We recommend the screen solder printing method as the method of cream.
- Please refer to the recommended PC board specification diagram for the PC board foot pattern.
- Self alignment may not always work as expected; therefore, please carefully adjust the position of the terminals and pattern.
- The temperature of the profile is assumed to be a value measured with the PC board of the terminal neighborhood.
- When you do the reflow solder to the back of the PC board after the reflow of the sensor, please execute fixed processing, for instance, with the adhesive etc.

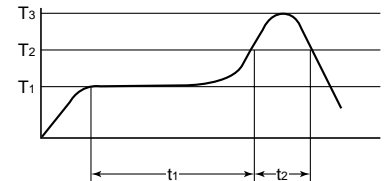

T₁ = 150 to 180°C 302 to 356°F t₁ = 60 to 120s
T₂ = 230°C 446°F t₂ = within 30s
T₃ = within 250°C 482°F

3) When you cut or fold the PC board after mounting the sensor, be careful not to stress to the soldered parts.

- 4) Solder reworking
 - Finish reworking in one operation.
 - For reworking of the solder bridge, use a soldering iron with a flat tip. Please do not add more flux when reworking.
 - The temperature of the soldering tip must be under the above-mentioned temperature.
- 5) The sensor terminals are designed to be exposed, so contact of the terminals with metal shards and the like will cause output errors. Therefore, please be careful not to touch the terminals with the metal piece or the hand.

Infrared Array Sensor Grid-EYE (AMG88)

6) To prevent the insulation of the PC board after soldering, please be careful not to place the chemicals on the sensor when coating.

7. Connections

- 1) Please perform connections correctly in accordance with the terminal connection diagram. In particular, be careful not to reverse wire the power supply as this will cause damage or degrade to the sensor.
- 2) Please do not connect wires in an empty terminal. It causes the sensor breakdown.
- 3) When using the sensors with cables, it is recommended that cables which are shielded and as short as possible be used in order to safeguard against the effects of noise.

8. Cleaning

Avoid ultrasonic cleaning since this may cause breaks or disconnections in the wiring.

9. Transportation and storage

- 1) Extreme vibration and shock during transport will damage the sensor. Handle the outer box and reel with care.
- 2) Storage under extreme conditions will cause soldering degradation, external appearance defects, and deterioration of the characteristics. The following storage conditions are recommended.
 - Temperature: 0 to 45°C 32 to 113°F
 - Humidity: less than 70% R.H.
 - Atmosphere: No harmful gasses such as sulfurous acid gas, minimal dust.
- 3) The sensors are sensitive to moisture and come in moisture-proof packages. Observe the following cautions when storing.
 - After the moisture-proof package is unsealed, take the sensors out of storage

as soon as possible (within 1 week \leq 30°C 86°F/60% R.H.).

- If the sensors are to be left in storage for a considerable period after the moisture-proof package has been unsealed, it is recommended to keep them in another moisture-proof bag containing silica gel (within 3 months at the most).

*When mounting with solder, if thermal stress is applied to sensors that have absorbed moisture, the moisture will vaporize, swelling will occur, and the inside of the package will become stressed. This may cause the package surface to blister or crack. Therefore, please take caution and observe the soldering conditions.

10. Special remarks

Although the best attention will be paid for the quality controls of the products, please consider the followings:

- 1) To prevent unexpected failures as much as possible under the conditions not shown in this specifications, please let us know the detailed information on the application, such as the environmental, operational and mounting condition.
- 2) By any chance, if the failure of the product is considered to cause a personal injury or death or property damage, the safety rate should be added to the specified values shown in this specifications and the dual safety structure or circuit is recommended to be taken from the stand point of the product liability indemnity.
- 3) We will either repair or replace any products or parts there of which prove to be defective against only the items written in this specifications within 1 year from the date of products acceptance at the site of delivery. Following cases are not covered by this guarantee.

- The case of other damage caused by the failure or defect of the product.
- The case that the product condition changed by handling, storage and/or transportation after delivery.
- The case caused by the phenomenon which has never been discovered and is impossible to be foreknown with the existing technologies.
- The case of force majeure, such as acts of God, public enemy or war, fires, floods and any other causes beyond the control of the people concerned.

11. Export control

[To customers in Japan]

This product is restricted under Japan's "Foreign Exchange and Foreign Trade Law." An export permit from the Japanese government is required when you export or take this product outside Japan. (As of Apr.2011)

This product may not be used for any purpose other than those specified. Reselling the product to third parties is prohibited. When disposing of the product, it must first be converted into non-reusable and non-controlled form.

[To customers outside Japan]

This product is restricted under Japan's laws and regulations relating to security export control (Foreign Exchange and Foreign Trade Law). We have obtained an export permit from the Japanese government to sell or provide this product to your company, subject to the following: This product may not be used for any purpose other than those specified. This product may be subject to further export restrictions under the laws and regulations of other countries (including your own). Reselling the product to third parties is prohibited. When disposing of the product, it must first be converted into non-reusable and non-controlled form.