

INFRA-RED

Item No.: 124141 H

1. This specification applies to GaAlAs / GaAlAs LED Chips (substrate removed)
2. Structure
 - 2.1 Mesa structure
 - 2.2 Electrodes

p-side (anode)	Au alloy
n-side (cathode)	Au alloy
3. Outlines (dimensions in microns)

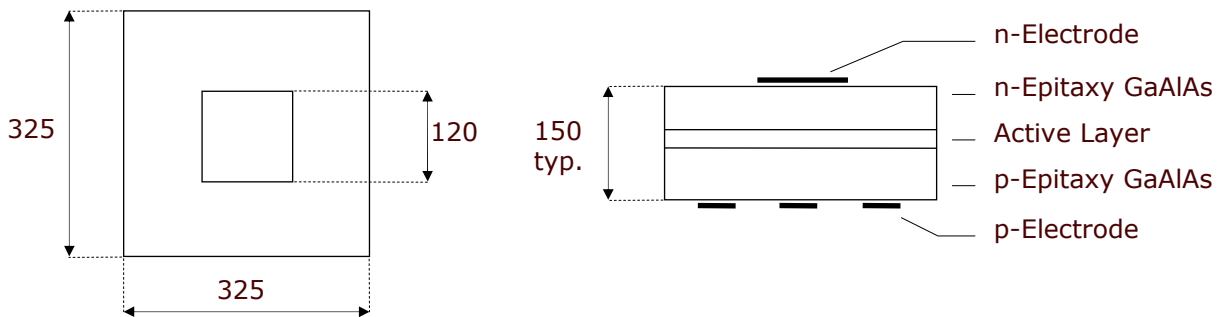

Wire bond contacts can also have a spider shape

4. Electrical and optical characteristics (T=25°C)

Parameter	Symbol	Conditions	min	typ	max	Unit
Forward voltage	V_F	$I_F = 20 \text{ mA}$		1,70	2,10	V
Reverse voltage	V_R	$I_R = 10 \text{ }\mu\text{A}$	5			V
output Power *	Φ_e	$I_F = 20 \text{ mA}$	2,4	3,2		mW
Switching time	t_r, t_f	$I_F = 20 \text{ mA}$		40		ns
Peak wavelength	λ_p	$I_F = 20 \text{ mA}$		780		nm

Power measurement at OSA on gold plate

5. Packing

Dice on adhesive film with 1) wire bond side on top
2) back contact on top

6. Labeling

Type	Lot No.	Φ_e typ min max	Quantity