

General Description

The AO4832 uses advanced trench technology to provide excellent $R_{DS(ON)}$ with low gate charge.

This device is suitable for high side switch in SMPS and general purpose applications.

Features

V_{DS}	30V
I_D (at $V_{GS}=10V$)	10A
$R_{DS(ON)}$ (at $V_{GS}=10V$)	< 13m Ω
$R_{DS(ON)}$ (at $V_{GS}=4.5V$)	< 17.5m Ω

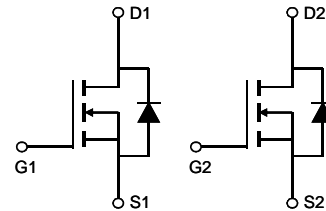
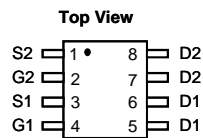

Absolute Maximum Ratings $T_A=25^\circ\text{C}$ unless otherwise noted

Parameter	Symbol	Maximum	Units
Drain-Source Voltage	V_{DS}	30	V
Gate-Source Voltage	V_{GS}	± 20	V
Continuous Drain Current	I_D	$T_A=25^\circ\text{C}$	10
		$T_A=70^\circ\text{C}$	8
Pulsed Drain Current ^C	I_{DM}	55	A
Avalanche Current ^C	I_{AS}, I_{AR}	22	A
Avalanche energy $L=0.1\text{mH}$ ^C	E_{AS}, E_{AR}	24	mJ
Power Dissipation ^B	P_D	$T_A=25^\circ\text{C}$	2
		$T_A=70^\circ\text{C}$	1.3
Junction and Storage Temperature Range	T_J, T_{STG}	-55 to 150	$^\circ\text{C}$

Thermal Characteristics

Parameter	Symbol	Typ	Max	Units
Maximum Junction-to-Ambient ^A	$R_{\theta JA}$	48	62.5	$^\circ\text{C}/\text{W}$
Maximum Junction-to-Ambient ^{A,D}		Steady-State	74	90
Maximum Junction-to-Lead	$R_{\theta JL}$	32	40	$^\circ\text{C}/\text{W}$

Electrical Characteristics (T_J=25°C unless otherwise noted)

Symbol	Parameter	Conditions	Min	Typ	Max	Units
STATIC PARAMETERS						
BV _{DSS}	Drain-Source Breakdown Voltage	I _D =250μA, V _{GS} =0V	30			V
I _{DSS}	Zero Gate Voltage Drain Current	V _{DS} =30V, V _{GS} =0V T _J =55°C			1 5	μA
I _{GSS}	Gate-Body leakage current	V _{DS} =0V, V _{GS} =±20V			100	nA
V _{GS(th)}	Gate Threshold Voltage	V _{DS} =V _{GS} , I _D =250μA	1.5	1.9	2.5	V
I _{D(ON)}	On state drain current	V _{GS} =10V, V _{DS} =5V	55			A
R _{DS(ON)}	Static Drain-Source On-Resistance	V _{GS} =10V, I _D =10A T _J =125°C		10.8	13	mΩ
		V _{GS} =4.5V, I _D =8A		14	17.5	
g _{FS}	Forward Transconductance	V _{DS} =5V, I _D =10A		43		S
V _{SD}	Diode Forward Voltage	I _S =1A, V _{GS} =0V		0.75	1	V
I _S	Maximum Body-Diode Continuous Current				2.5	A
DYNAMIC PARAMETERS						
C _{iss}	Input Capacitance	V _{GS} =0V, V _{DS} =15V, f=1MHz	610	760	910	pF
C _{oss}	Output Capacitance		88	125	160	pF
C _{riss}	Reverse Transfer Capacitance		40	70	100	pF
R _g	Gate resistance	V _{GS} =0V, V _{DS} =0V, f=1MHz	0.8	1.6	2.4	Ω
SWITCHING PARAMETERS						
Q _{g(10V)}	Total Gate Charge	V _{GS} =10V, V _{DS} =15V, I _D =10A	11	14	17	nC
Q _{g(4.5V)}	Total Gate Charge		5	6.6	8	nC
Q _{gs}	Gate Source Charge			2.4		nC
Q _{gd}	Gate Drain Charge			3		nC
t _{D(on)}	Turn-On DelayTime	V _{GS} =10V, V _{DS} =15V, R _L =1.5Ω, R _{GEN} =3Ω		4.4		ns
t _r	Turn-On Rise Time			9		ns
t _{D(off)}	Turn-Off DelayTime			17		ns
t _f	Turn-Off Fall Time			6		ns
t _{rr}	Body Diode Reverse Recovery Time	I _F =10A, dI/dt=500A/μs	5.6	7	8	ns
Q _{rr}	Body Diode Reverse Recovery Charge	I _F =10A, dI/dt=500A/μs	6.4	8	9.6	nC

A. The value of R_{θJA} is measured with the device mounted on 1in² FR-4 board with 2oz. Copper, in a still air environment with T_A=25° C. The value in any given application depends on the user's specific board design.

B. The power dissipation P_D is based on T_{J(MAX)}=150° C, using ≤ 10s junction-to-ambient thermal resistance.

C. Repetitive rating, pulse width limited by junction temperature T_{J(MAX)}=150° C. Ratings are based on low frequency and duty cycles to keep initial T_J=25° C.

D. The R_{θJA} is the sum of the thermal impedance from junction to lead R_{θJL} and lead to ambient.

E. The static characteristics in Figures 1 to 6 are obtained using <300μs pulses, duty cycle 0.5% max.

F. These curves are based on the junction-to-ambient thermal impedance which is measured with the device mounted on 1in² FR-4 board with 2oz. Copper, assuming a maximum junction temperature of T_{J(MAX)}=150° C. The SOA curve provides a single pulse rating.

TYPICAL ELECTRICAL AND THERMAL CHARACTERISTICS

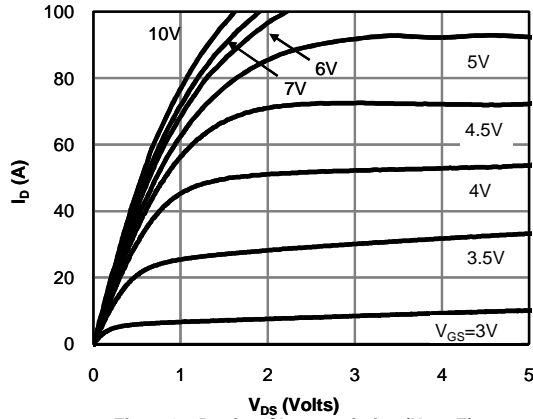

Fig 1: On-Region Characteristics (Note E)

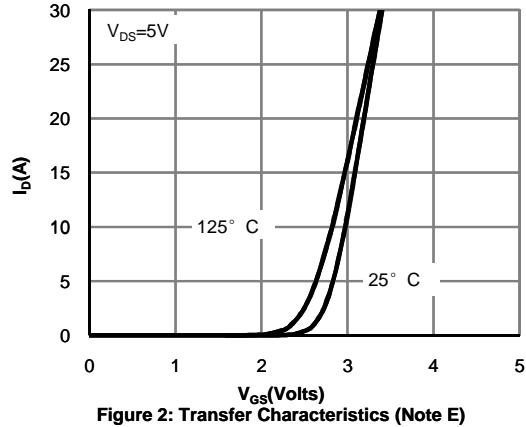

Figure 2: Transfer Characteristics (Note E)

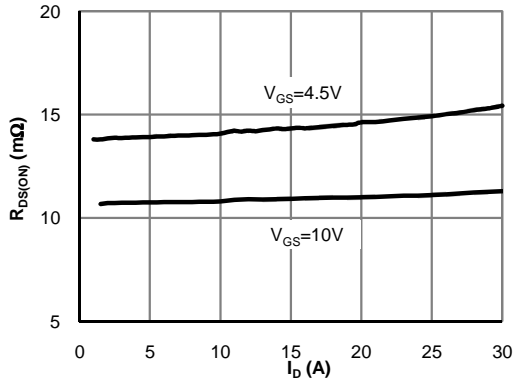

Figure 3: On-Resistance vs. Drain Current and Gate Voltage (Note E)

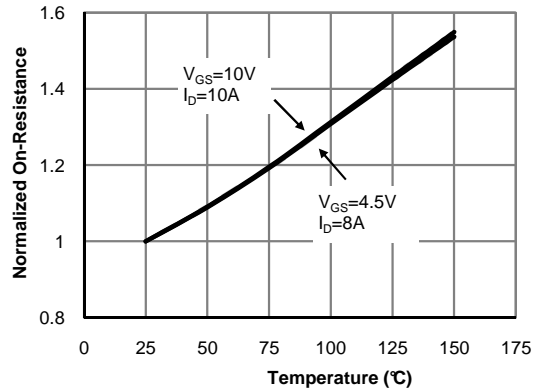

Figure 4: On-Resistance vs. Junction Temperature (Note E)

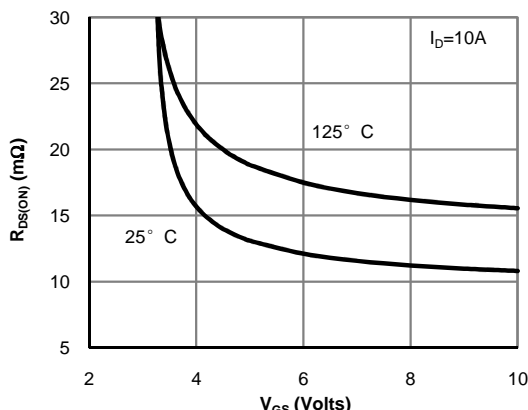

Figure 5: On-Resistance vs. Gate-Source Voltage (Note E)

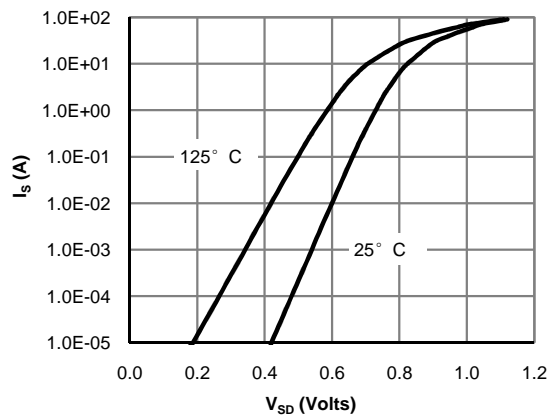

Figure 6: Body-Diode Characteristics (Note E)

TYPICAL ELECTRICAL AND THERMAL CHARACTERISTICS

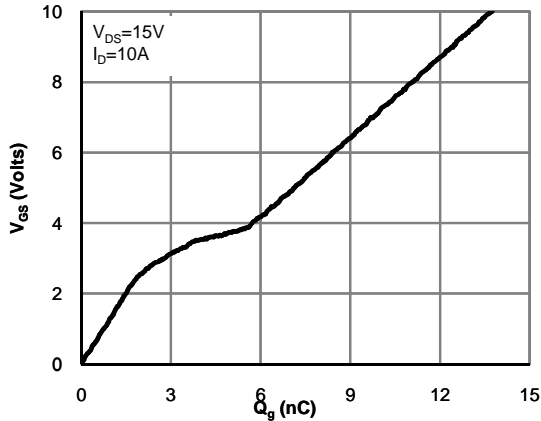

Figure 7: Gate-Charge Characteristics

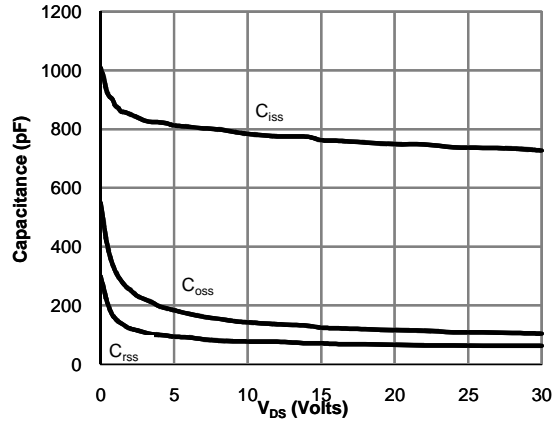

Figure 8: Capacitance Characteristics

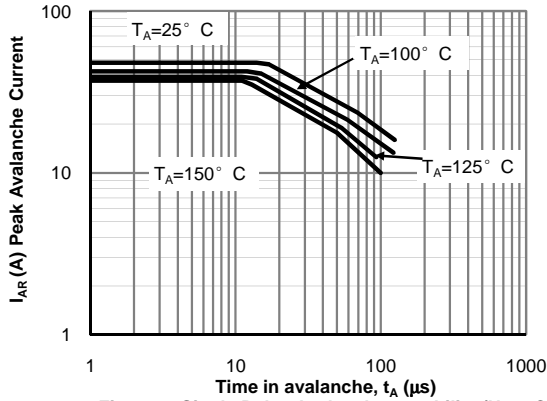

Figure 9: Single Pulse Avalanche capability (Note C)

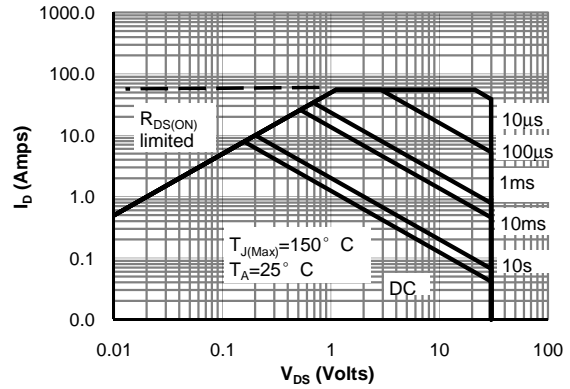

Figure 10: Maximum Forward Biased Safe Operating Area (Note F)

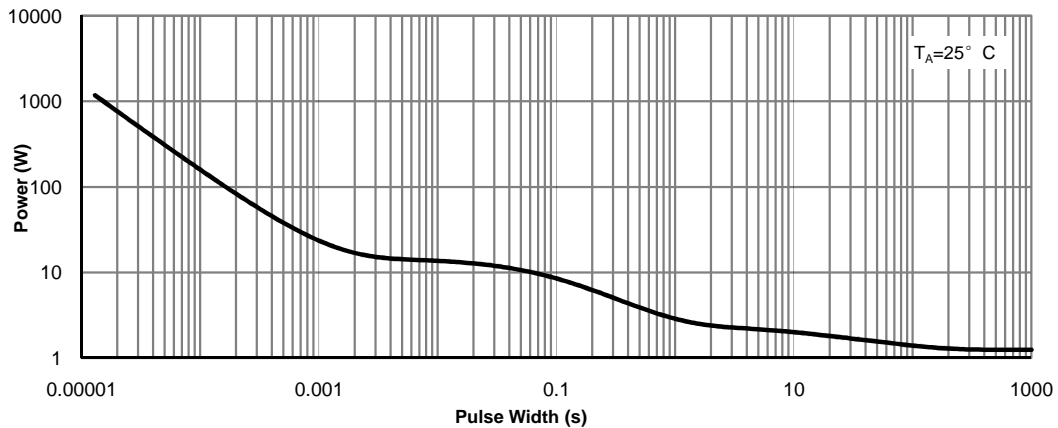
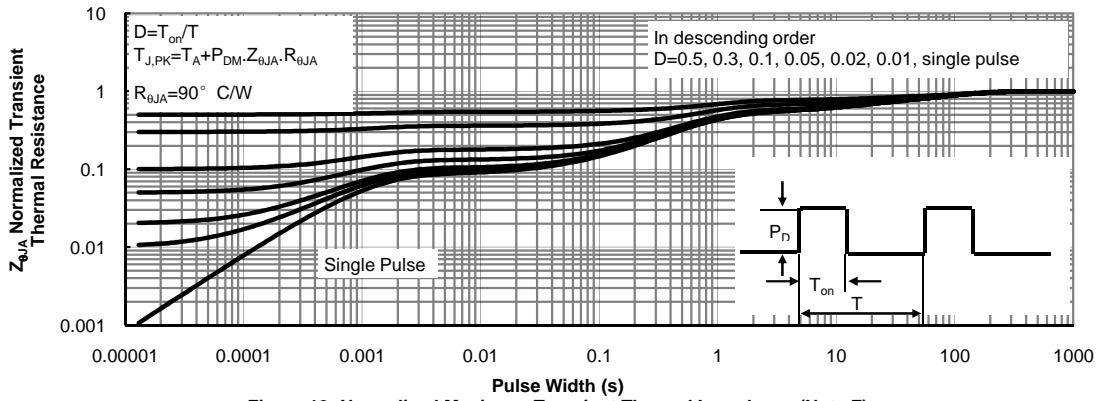
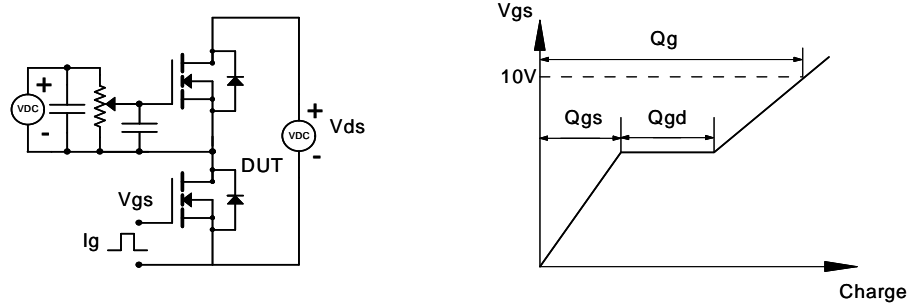

Figure 11: Single Pulse Power Rating Junction-to-Ambient (Note F)

TYPICAL ELECTRICAL AND THERMAL CHARACTERISTICS



Gate Charge Test Circuit & Waveform



Resistive Switching Test Circuit & Waveforms

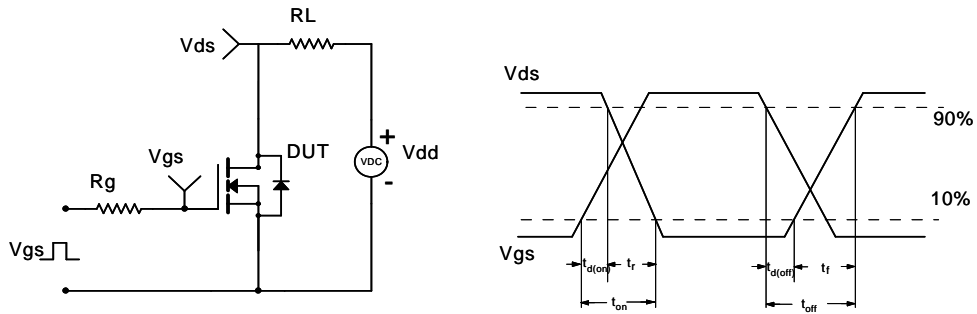

Unclamped Inductive Switching (UIS) Test Circuit & Waveforms

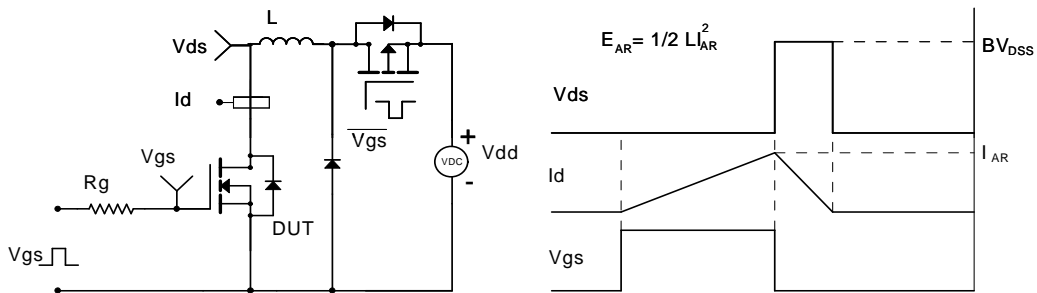

Diode Recovery Test Circuit & Waveforms

