

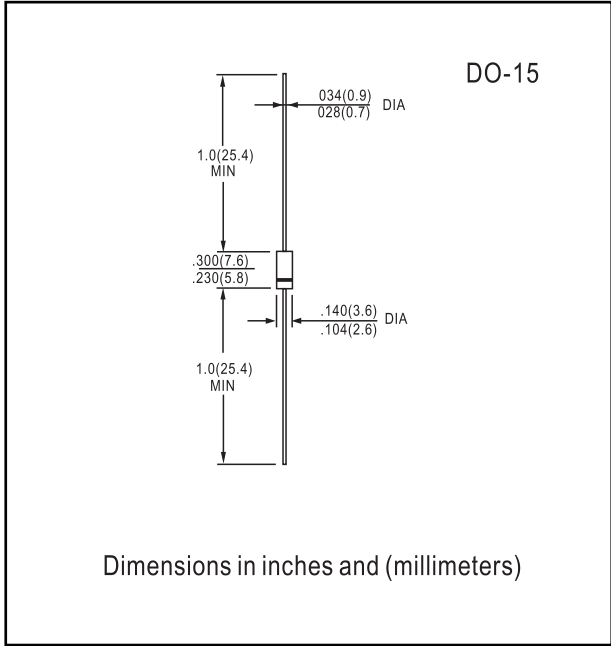

- FEATURES**
- Glass Passivated Die Construction
 - Diffused Junction
 - Super-Fast Switching for High Efficiency
 - High Current Capability and Low Forward Voltage Drop
 - Surge Overload Rating to 60A Peak
 - Low Reverse Leakage Current
 - Plastic Material: UL Flammability Classification Rating 94V-0



Mechanical Data

- Case: Molded Plastic
- Terminals: Plated Leads Solderable per MIL-STD-202, Method 208
- Polarity: Cathode Band
- Marking: Type Number
- Weight: 0.35 grams (approx.)
- Mounting Position: Any

MAXIMUM RATINGS AND ELECTRICAL CHARACTERISTICS

Single phase, half wave, 60Hz, resistive or inductive load.
For capacitive load, derate current by 20%.

Characteristic	Symbol	SF20 AG	SF20 BG	SF20 CG	SF20 DG	SF20 FG	SF20 GG	SF20 HG	SF20 JG	Unit
Peak Repetitive Reverse Voltage	V_{RRM}	50	100	150	200	300	400	500	600	V
Working Peak Reverse Voltage	V_{RWM}									
DC Blocking Voltage	V_R									
RMS Reverse Voltage	$V_{R(RMS)}$	35	70	105	140	210	280	350	420	V
Average Rectified Output Current @ $T_A = 75^\circ C$ (Note 1)	I_O	2.0								A
Non-Repetitive Peak Forward Surge Current 8.3ms Single half sine-wave Superimposed on Rated Load (JEDEC Method)	I_{FSM}	60								A
Forward Voltage @ $I_F = 2.0A$	V_{FM}	0.95			1.3		1.5			V
Peak Reverse Current @ $T_A = 25^\circ C$ at Rated DC Blocking Voltage @ $T_A = 100^\circ C$	I_{RM}					10 100				μA
Reverse Recovery Time (Note 2)	t_{rr}	35			40		50			ns
Typical Junction Capacitance (Note 3)	C_j	75						50		pF
Typical Thermal Resistance Junction to Ambient	$R_{\theta JA}$	40								K/W
Operating and Storage Temperature Range	T_j, T_{STG}	-65 to +150								$^\circ C$

Notes: 1. Valid provided that leads are kept at ambient temperature at a distance of 9.5mm from the case.
2. Measured with $I_F = 0.5A$, $I_R = 1.0A$, $t_{rr} = 0.25A$. See Figure 5.
3. Measured at 1.0MHz and applied reverse voltage of 4.0V DC.

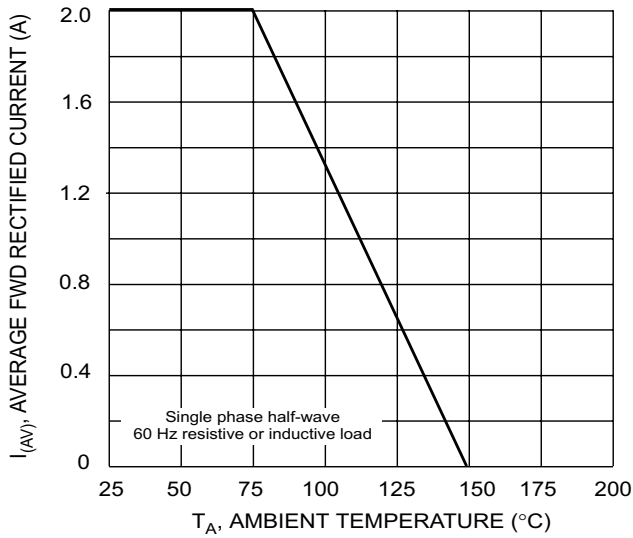

Fig. 1 Forward Current Derating Curve

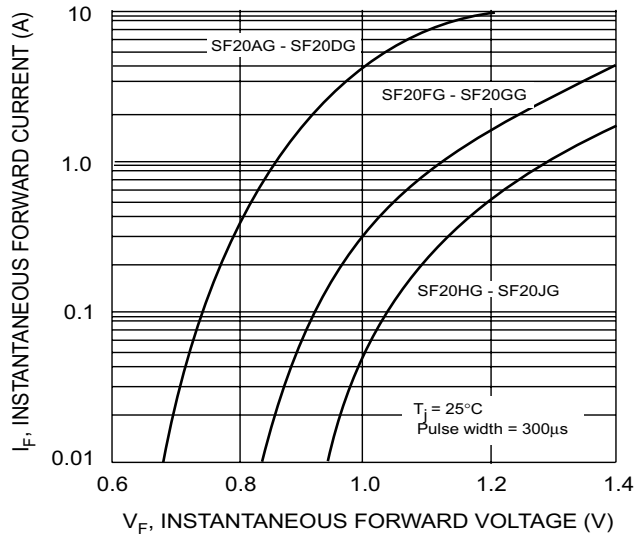

Fig. 2 Typical Forward Characteristics

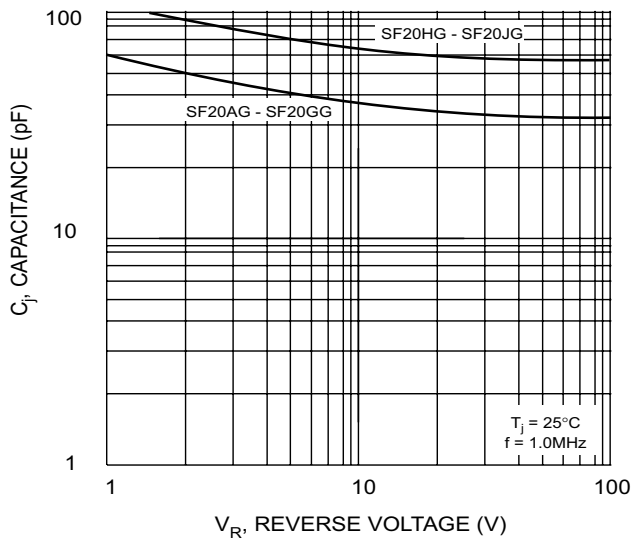

Fig. 4 Typical Junction Capacitance

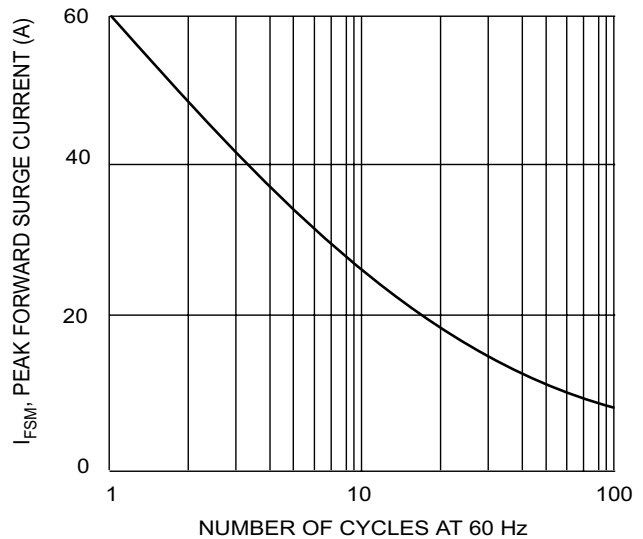
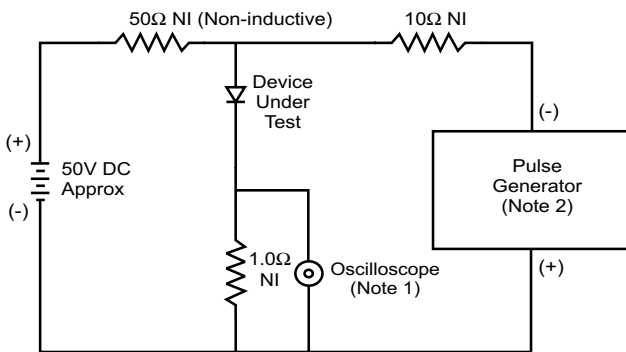
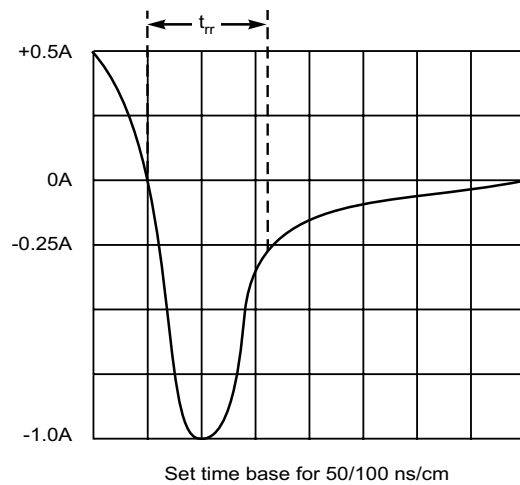

Fig. 3 Peak Forward Surge Current



- Notes:
 1. Rise Time = 7.0ns max. Input Impedance = 1.0MΩ, 22pF.
 2. Rise Time = 10ns max. Input Impedance = 50Ω.



Set time base for 50/100 ns/cm

Fig. 5 Reverse Recovery Time Characteristic and Test Circuit