

**Features**

- Low Saturation Voltage  $V_{CE(sat)}=1.65V$  typ. ( $I_C=25A$ )
- High Speed SW  $t_f=120ns$  typ. ( $I_C=25A$ )

**Package**

TO-3PF

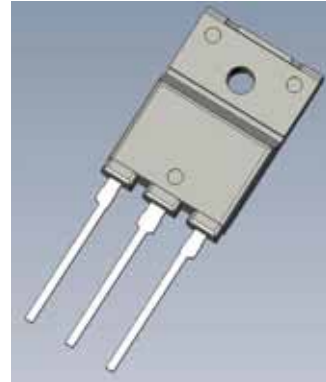

**Applications**

- Current Resonance Inverter Switching

**Equivalent circuit**

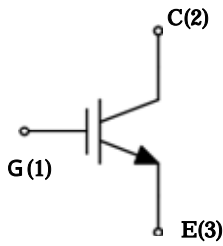

**Absolute maximum ratings**

( $T_a=25^{\circ}C$ )

Characteristic	Symbol	Rating	Unit
Collector to Emitter Voltage	$V_{CES}$	600	V
Gate to Emitter Voltage	$V_{GES}$	$\pm 30$	V
Continuous Collector Current	$I_C$	25	A
Pulsed Collector Current	$I_C(\text{pulse})$ <sup>1)</sup>	75	A
Maximum Collector-emitter $dv/dt$	$dv/dt$ <sup>2)</sup>	5	V/ns
Maximum Power Dissipation	PC	60 ( $T_c=25^{\circ}C$ )	W
Thermal Resistance IGBT	$\theta_{j-c}$	2.08	$^{\circ}C/W$
Junction Temperature	$T_j$	150	$^{\circ}C$
Storage Temperature	$T_{stg}$	- 55~150	$^{\circ}C$

1) PW 10ms., Duty cycle 1%

2)  $T_c$  125 $^{\circ}C$ , See Fig.1

**Electrical characteristics**

●IGBT

(Ta=25°C)

Characteristic	Symbol	Test Conditions	Limits			Unit
			MIN.	TYP.	MAX.	
Collector to Emitter Breakdown Voltage	V(BR)CES	IC=100μA, VGE=0V	600			V
Gate to Emitter Leakage Current	IGES	VGE=±30V			±500	nA
Collector to Emitter Leakage Current	ICES	VCE=600V, VGE=0V			100	μA
Gate Threshold Voltage	VGE(th)	VCE=10V, IC=1mA	4		7	V
Collector to Emitter Saturation Voltage	VCE(sat)	VGE=15V, IC=25A		1.65	1.9	V
Collector to Emitter Saturation Voltage	VCE(sat)	VGE=15V, IC=40A		2.0		V
Input Capacitance	Cies	VCE=20V VGE=0V f=1MHz		1300		pF
Output Capacitance	Coes			80		
Reverse Transfer Capacitance	Cres			40		
Gate charge	Qgate	VCE=300V IC=25A VGE=15V		40		nC
Gate to Collector Charge	Qgc			10		
Gate to Emitter Charge	Qge			10		
Turn-On Delay Time	td(on)	VCE=300V, IC=25A VGE=15V, RG=39Ω L=100uH, Tc=25°C See Fig.1		50		ns
Rise Time	tr			60		
Turn-Off Delay Time	td(off)			200		
Fall Time	tf			120		
Turn-On Delay Time	td(on)	VCE=300V, IC=25A VGE=15V, RG=39Ω L=100uH, Tc=125°C See Fig.1		50		ns
Rise Time	tr			60		
Turn-Off Delay Time	td(off)			200		
Fall Time	tf			200		

The information included herein is believed to be accurate and reliable. However, SANKEN ELECTRIC CO., LTD assumes no responsibility for its use ; nor for any infringements of patents or other rights of third parties that may result from its use.

Fig.1 Switching Time Test Method

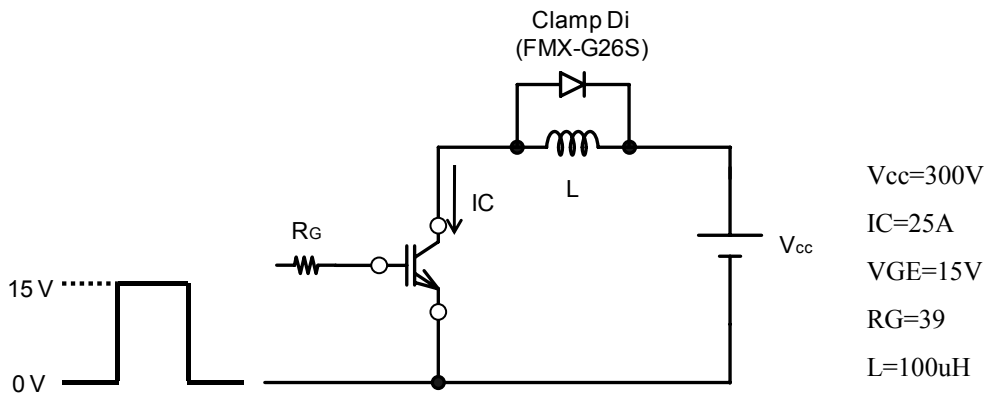

(a) Test Circuit

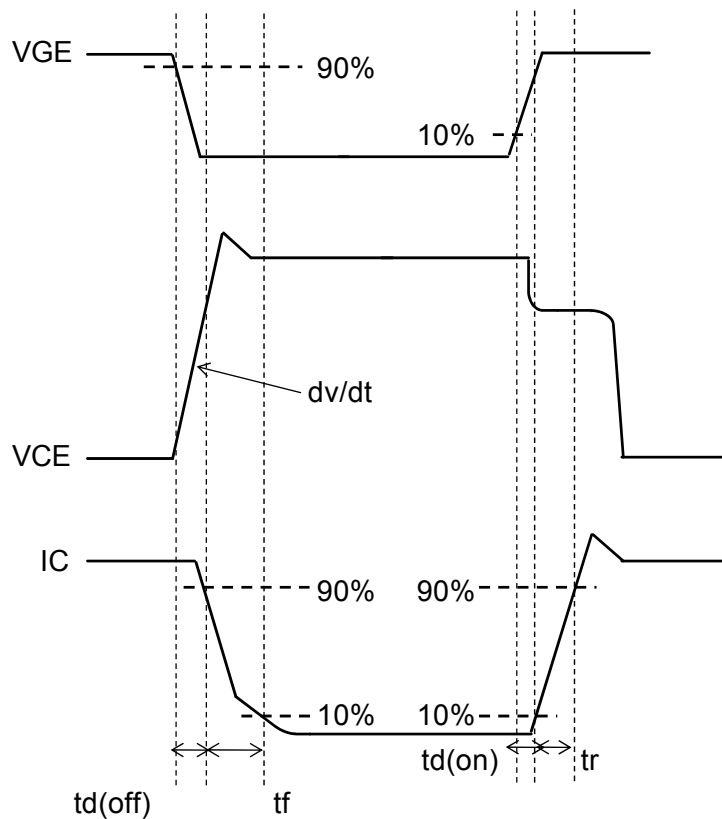

(b) Waveforms

The information included herein is believed to be accurate and reliable. However, SANKEN ELECTRIC CO., LTD assumes no responsibility for its use ; nor for any infringements of patents or other rights of third parties that may result from its use.

**Characteristic Curves**

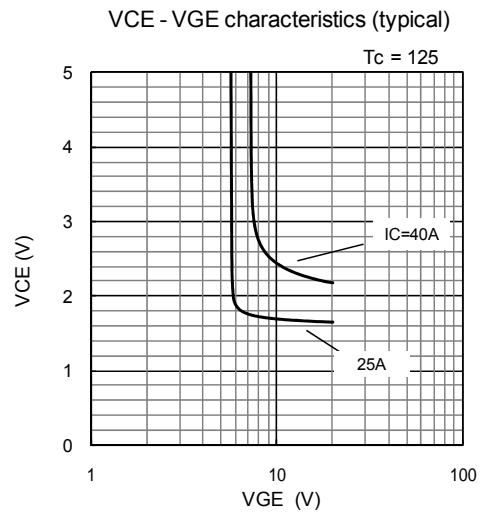
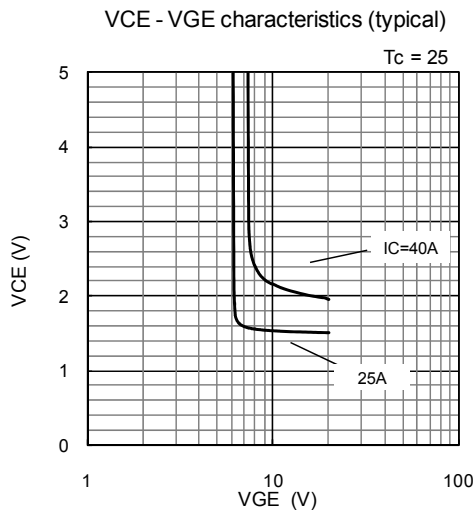
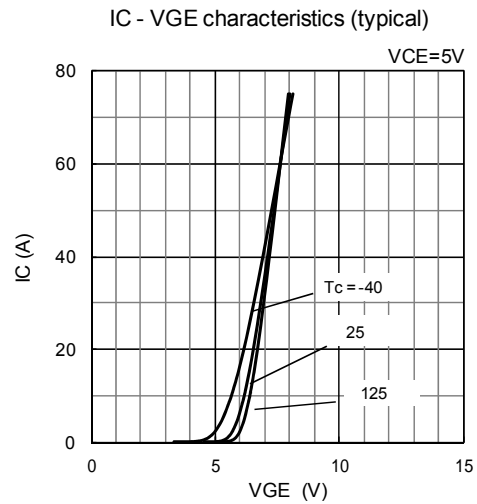
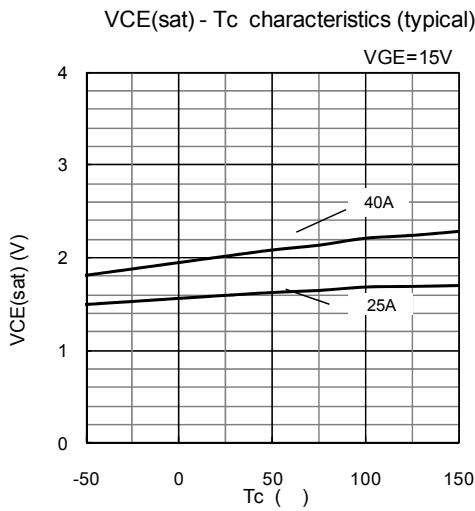
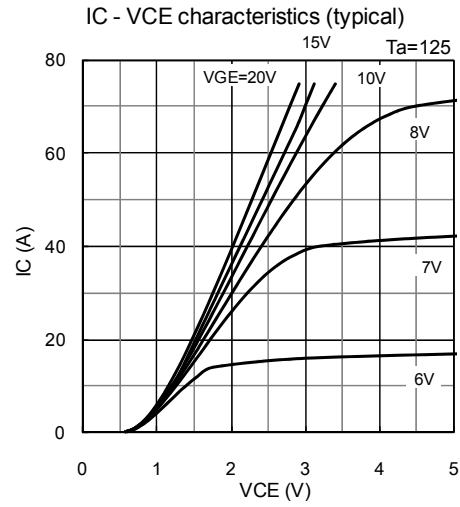
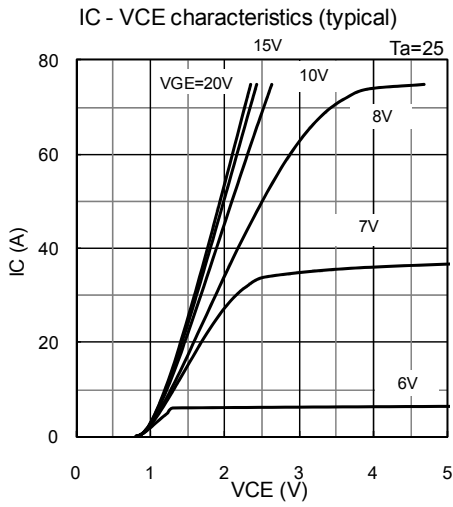

The information included herein is believed to be accurate and reliable. However, SANKEN ELECTRIC CO., LTD assumes no responsibility for its use ; nor for any infringements of patents or other rights of third parties that may result from its use.

**Characteristic Curves**

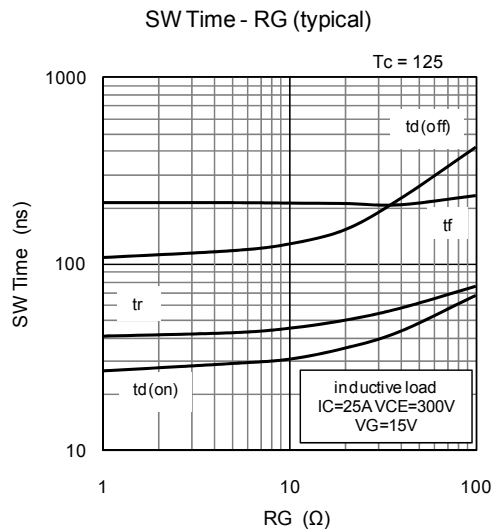
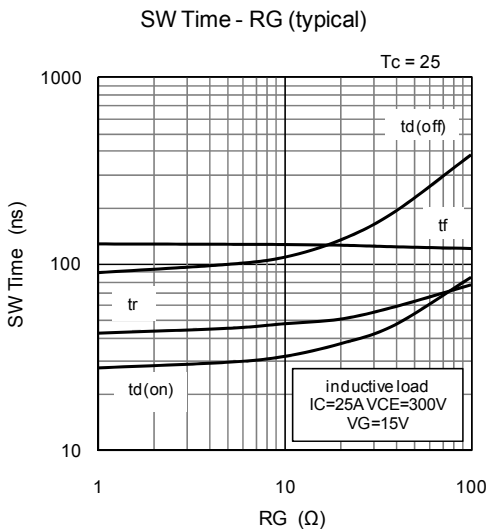
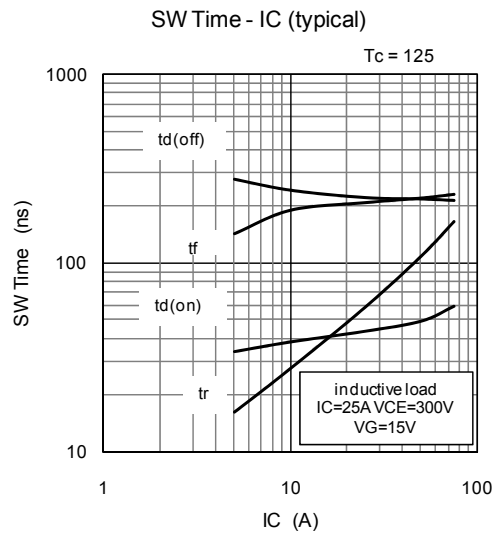
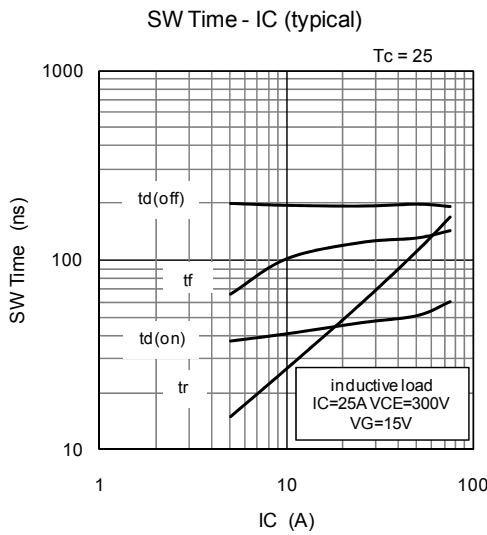
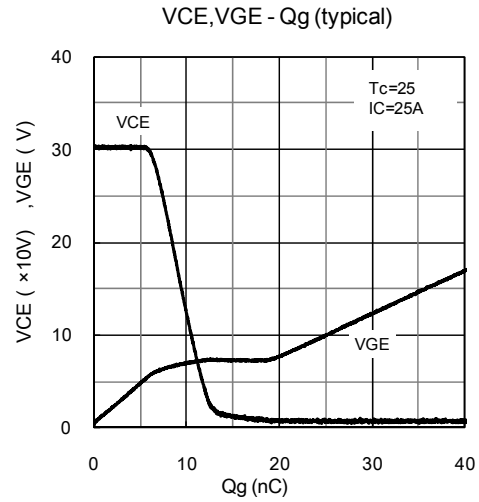
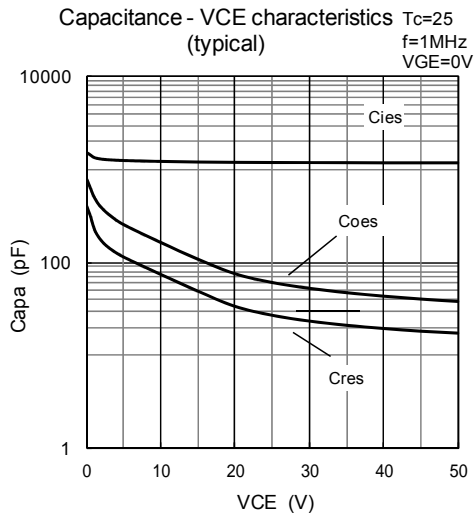

The information included herein is believed to be accurate and reliable. However, SANKEN ELECTRIC CO., LTD assumes no responsibility for its use ; nor for any infringements of patents or other rights of third parties that may result from its use.

**Characteristic Curves**

Reverse Bias ASO

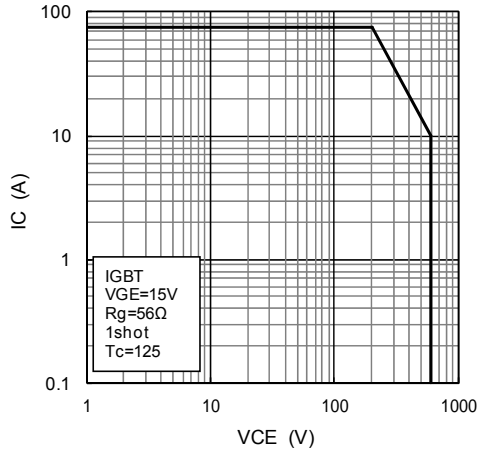

SAFE OPERATING AREA

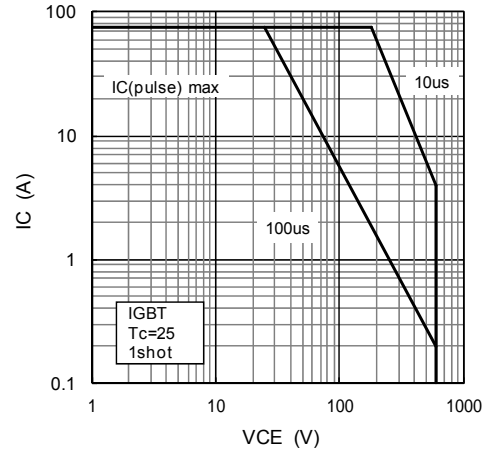

TRANSIENT THERMAL RESISTANCE - PULSE WIDTH

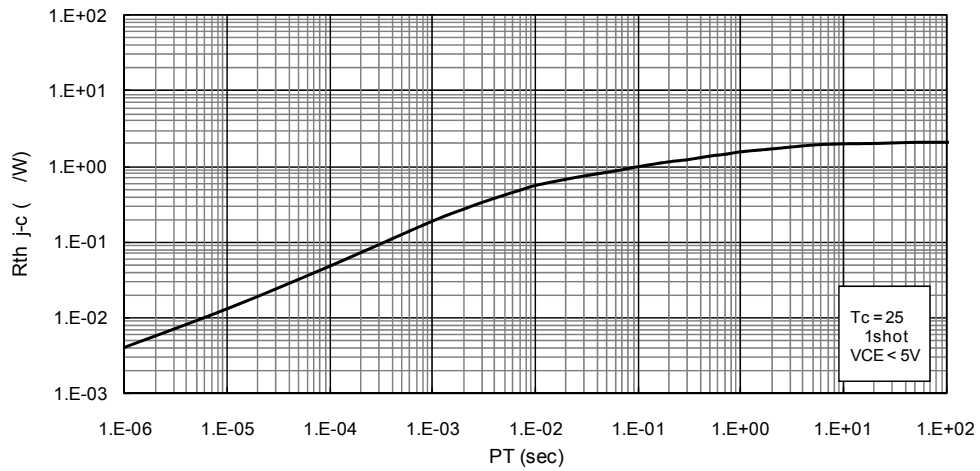

The information included herein is believed to be accurate and reliable. However, SANKEN ELECTRIC CO., LTD assumes no responsibility for its use ; nor for any infringements of patents or other rights of third parties that may result from its use.

**Outline**

TO-3PF

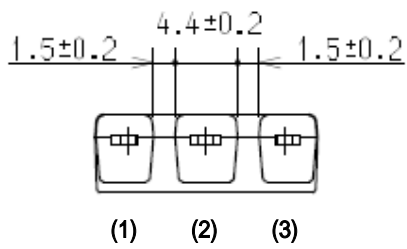
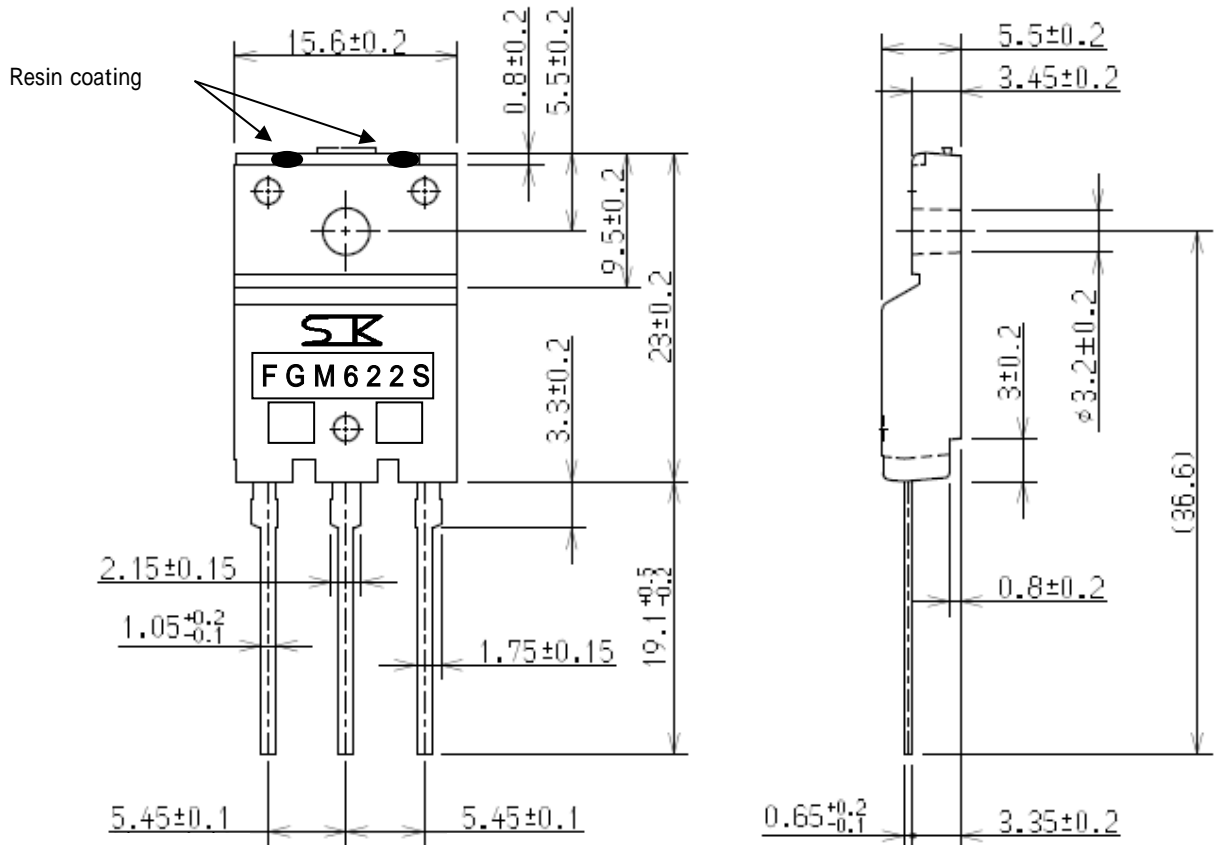

- (1) Gate
- (2) Collector
- (3) Emitter

Wight Approx : 6.5g

The information included herein is believed to be accurate and reliable. However, SANKEN ELECTRIC CO., LTD assumes no responsibility for its use ; nor for any infringements of patents or other rights of third parties that may result from its use.