

BACK VIEW

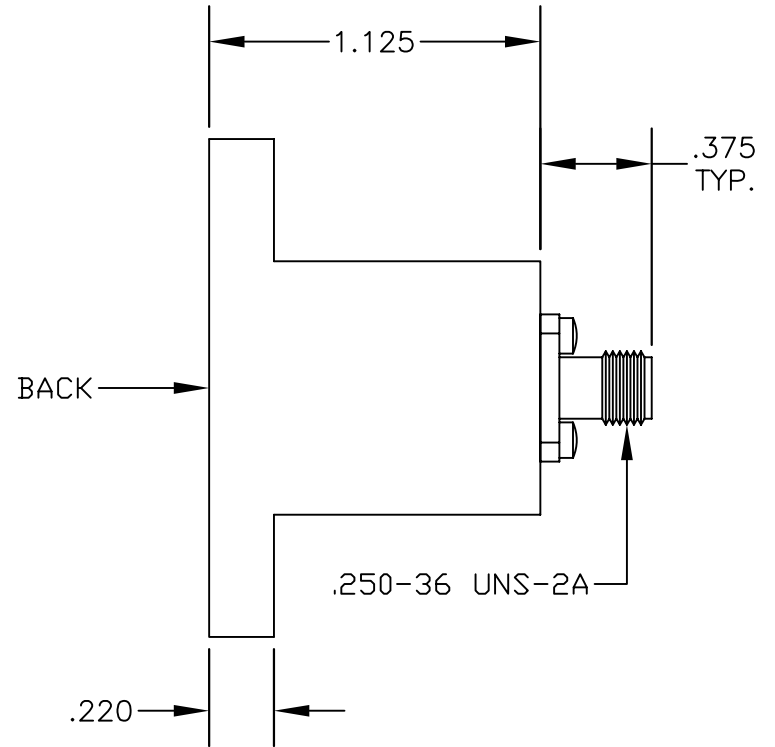

PASTERNACK ENTERPRISES, INC.

P.O BOX 16759, IRVINE, CA 92623
PHONE (949) 261-1920 FAX (949) 261-7451

WEB ADDRESS: www.pasternack.com
E-MAIL ADDRESS: sales@pasternack.com

COAXIAL & FIBER OPTICS

DWG TITLE

PE9849

DES.

WAVEGUIDE END LAUNCH TO SMA
TYPE FEMALE
FREQUENCY RANGE: 7.00 - 11.00 GHz

SIZE A

FSCM NO. 53919

CAD FILE 101104

SCALE N/A

147

NOTES:

1. UNLESS OTHERWISE SPECIFIED ALL DIMENSIONS ARE NOMINAL.
2. ALL SPECIFICATIONS ARE SUBJECT TO CHANGE WITHOUT NOTICE AT ANY TIME.