

MAX17497A/MAX17497B

AC-DC and DC-DC Peak-Current-Mode Converters with Integrated Step-Down Regulator

General Description

The MAX17497A/MAX17497B include both a current-mode fixed-frequency PWM converter and a synchronous step-down regulator. They contain all the control circuitry required to design wide-input-voltage nonisolated power supplies to supply multiple output rails for smart meters, industrial control, and other similar applications. The MAX17497A has its rising/falling undervoltage lockout (UVLO) thresholds optimized for universal offline (85V AC to 265V AC) applications, while the MAX17497B supports undervoltage lockout (UVLO) thresholds suitable to low-voltage DC-DC applications. Both devices also include a 3.3V fixed-output synchronous step-down regulator that delivers up to 600mA load current.

The switching frequency of the MAX17497A flyback converter is 250kHz, while the MAX17497B flyback/boost converter is 500kHz. The internally compensated synchronous step-down regulator switches at 1MHz on both versions. These frequencies allow the use of tiny magnetic and filter components resulting in compact, cost-effective power supplies. An EN/UVLO input allows the user to start the power supply precisely at the desired input voltage, while also functioning as an on/off pin. The OVI pin enables implementation of an input overvoltage-protection scheme that ensures the converter shuts down when the DC input voltage exceeds the desired maximum value.

Programmable current limit allows proper sizing and protection of the primary switching FET. The MAX17497B supports a maximum duty cycle of 93% and provides programmable slope compensation to allow optimization of control loop performance. The MAX17497A supports a maximum duty cycle of 49%, and has a fixed internal slope compensation for optimum control loop performance. The devices provide an open-drain RESETN pin that serves as a power-good indicator and enters the high-impedance state to indicate that the flyback/boost converter and 3.3V step-down regulator outputs are in regulation. An SSF pin allows programmable soft-start time for the flyback/boost converter, while an internal digital soft-start is employed for the 3.3V step-down regulator to limit inrush current. Hiccup mode overcurrent protection and thermal shutdown are provided to minimize dissipation under overcurrent and overtemperature fault conditions. The devices are available in a space-saving 16-pin (3mm x 3mm) TQFN package with 0.5mm lead spacing.

Benefits and Features

- ◆ **Reduced Component Count and Board Space**
 - ◇ Flyback/Boost with Integrated Internally Compensated Step-Down Regulator
 - ◇ No Current-Sense Resistor
 - ◇ Space-Saving 16-Pin (3mm x 3mm) TQFN Package
- ◆ **Minimal Radio Interference**
 - ◇ 250kHz Switching in Offline Version Minimizes Interference with Radio Receivers in Smart Meter Applications
- ◆ **Reduced Inrush Current**
 - ◇ Programmable Flyback/Boost Soft-Start
 - ◇ Internal Digital Soft-Start for Step-Down Regulator
- ◆ **Reduced Power Dissipation Under Fault**
 - ◇ Hiccup Mode Overcurrent Protection
 - ◇ Thermal Shutdown with Hysteresis
- ◆ **Robust Protection Features**
 - ◇ Flyback/Boost Programmable Current Limit
 - ◇ Input Overvoltage Protection
- ◆ **Optimized Loop Performance**
 - ◇ Programmable Slope Compensation for Flyback/Boost Maximizes Obtainable Phase Margin
- ◆ **High Efficiency**
 - ◇ 150mΩ, 65V-Rated nMOSFET Offers Typical Flyback Converter Efficiency Greater Than 80%
 - ◇ 3.3V Step-Down Regulator Efficiency Greater Than 90%
- ◆ **Optional Spread Spectrum**

Applications

AC-DC Power Supplies for Smart Meter Applications
 Universal-Input Offline AC-DC Power Supplies
 Wide-Range DC Input Flyback/Boost Industrial Power Supplies

Ordering Information appears at end of data sheet.

For related parts and recommended products to use with this part, refer to www.maxim-ic.com/MAX17497A.related.

MAX17497A/MAX17497B

AC-DC and DC-DC Peak-Current-Mode Converters with Integrated Step-Down Regulator

ABSOLUTE MAXIMUM RATINGS

IN to SGND	-0.3V to +40V
EN/UVLO to SGND	-0.3V to $V_{IN} + 0.3V$
OVI to SGND	-0.3V to $V_{CC} + 0.3V$
V_{CC} to SGND	-0.3V to +6V
SSF, RLIMF, EAFN, COMPF, SCOMPF to SGND	-0.3V to ($V_{CC} + 0.3V$)
LXF to SGND	-0.3V to +70V
INB to SGND	-0.3V to +26V
LXB to SGND	-0.3V to $V_{INB} + 0.3V$
OUTB to SGND	-0.3V to +6V

RESETN to SGND	-0.3V to +6V
PGNDF, PGNDB to SGND	-0.3V to +0.3V
Continuous Power Dissipation (Single-Layer Board)	
TQFN (derate 20.8mW/°C above +70°C) (Note 1)	... 1700mW
Operating Temperature Range	-40°C to +125°C
Storage Temperature Range	-65°C to +160°C
Junction Temperature (continuous)	+150°C
Lead Temperature (soldering, 10s)	+300°C
Soldering Temperature (reflow)	+260°C

Note 1: Package thermal resistances were obtained using the method described in JEDEC specification JESD51-7, using a four-layer board. For detailed information on package thermal considerations, refer to www.maxim-ic.com/thermal-tutorial.

Stresses beyond those listed under "Absolute Maximum Ratings" may cause permanent damage to the device. These are stress ratings only, and functional operation of the device at these or any other conditions beyond those indicated in the operational sections of the specifications is not implied. Exposure to absolute maximum rating conditions for extended periods may affect device reliability.

ELECTRICAL CHARACTERISTICS

($V_{IN} = +15V$, $V_{EN/UVLO} = +2V$, COMPF = open, $C_{IN} = 1\mu F$, $C_{VCC} = 1\mu F$, $T_A = T_J = -40^\circ C$ to $+125^\circ C$, unless otherwise noted. Typical values are at $T_A = +25^\circ C$.) (Note 2)

PARAMETER	CONDITIONS	MIN	TYP	MAX	UNITS
INPUT SUPPLY (V_{IN})					
IN Voltage Range (V_{IN})	MAX17497A	4.5		29	V
	MAX17497B	4.5		36	
IN Supply Startup Current Under UVLO	$I_{INSTARTUP}$, $V_{IN} < UVLO$ or $EN/UVLO = SGND$		22	36	μA
IN Supply Current (I_{IN})	Switching, $f_{SW} = 250kHz$ (MAX17497A)		2.75	4.5	mA
	Switching, $f_{SW} = 500kHz$ (MAX17497B)		3	5	
IN Bootstrap UVLO Rising Threshold	MAX17497A	19	20.5	22	V
	MAX17497B	3.9	4.15	4.4	
IN Bootstrap UVLO Falling		3.65	3.95	4.25	V
EN/UVLO Threshold	Rising	1.18	1.23	1.28	V
	Falling	1.11	1.17	1.21	
EN/UVLO Input Leakage Current	$0V < V_{EN/UVLO} < 1.5V$, $T_A = +25^\circ C$	-100	0	+100	nA
LDO					
V_{CC} Output Voltage Range	$6V < V_{IN} < 29V$, $0mA < I_{VCC} < 50mA$	4.8	5	5.2	V
V_{CC} Dropout Voltage	$V_{IN} = 4.5V$, $I_{VCC} = 20mA$		160	300	mV
V_{CC} Current Limit	$V_{CC} = 0V$, $V_{IN} = 6V$	50	100		mA
OVERVOLTAGE PROTECTION					
OVI Threshold	Rising	1.18	1.23	1.28	V
	Falling	1.11	1.17	1.21	
OVI Masking Delay			2		μs
OVI Input Leakage Current	$0V < V_{OVI} < 1.5V$, $T_A = +25^\circ C$	-100	0	+100	nA

MAX17497A/MAX17497B

AC-DC and DC-DC Peak-Current-Mode Converters with Integrated Step-Down Regulator

ELECTRICAL CHARACTERISTICS (continued)

($V_{IN} = +15V$, $V_{EN/UVLO} = +2V$, COMPF = open, $C_{IN} = 1\mu F$, $C_{VCC} = 1\mu F$, $T_A = T_J = -40^\circ C$ to $+125^\circ C$, unless otherwise noted. Typical values are at $T_A = +25^\circ C$.) (Note 2)

PARAMETER	CONDITIONS	MIN	TYP	MAX	UNITS
FLYBACK/BOOST CONVERTER					
Flyback/Boost Switching Frequency	MAX17497A	235	250	265	kHz
	MAX17497B	470	500	530	
Flyback/Boost Maximum Duty Cycle	$f_{SW} = 250kHz$ (MAX17497A)	47.5	48.75	50	%
	$f_{SW} = 500kHz$ (MAX17497B)	88	92	96	
SSF Pullup Current	$V_{SSF} = 400mV$	9	10	11	μA
SSF Set Point Voltage		1.18	1.23	1.28	V
SSF Peak Current-Limit Enable Threshold		1.11	1.17	1.21	V
EAFN Input Bias Current	$0V < V_{EAFN} < 1.5V$, $T_A = +25^\circ C$	-100		+100	nA
Error-Amplifier Open-Loop Voltage Gain			90		dB
Error-Amplifier Transconductance	$V_{COMP} = 2V$, $V_{RLIMF} = 1V$	1.5	1.8	2.1	mS
Error-Amplifier Source Current	$V_{COMP} = 2V$, $V_{EAFN} = 1V$	80	120	210	μA
Error-Amplifier Sink Current	$V_{COMP} = 2V$, $V_{EAFN} = 1.5V$	80	120	210	μA
Current-Sense Transresistance		0.45	0.5	0.55	Ω
IN Clamp Voltage	$EN/UVLO = SGND$, $I_{IN_} = 1mA$ (MAX17497A) (Note 3)	31	33.5	36	V
LXF DMOS Switch On-Resistance (R_{DSON_LXF})	$I_{LXF} = 200mA$		175	380	m Ω
LXF DMOS Peak Current Limit	$RLIMF = 100K$	1.62	1.9	2.23	A
LXF DMOS Runaway Current Limit	$RLIMF = 100K$	1.9	2.3	2.6	A
LXF Leakage Current	$V_{LXF} = 65V$, $T_A = +25^\circ C$		0.1	2	μA
Peak Switch Current Limit with RLIMF Open		0.35	0.45	0.54	A
Runaway Switch Current Limit with RLIMF Open		0.39	0.5	0.6	A
RLIMF Reference Current		9	10	11	μA
Number of Flyback/Boost Peak Current-Limit Hits Before Hiccup Timeout			8		#
Number of Flyback/Boost Runaway Current-Limit Hits Before Hiccup Timeout			1		#

MAX17497A/MAX17497B

AC-DC and DC-DC Peak-Current-Mode Converters with Integrated Step-Down Regulator

ELECTRICAL CHARACTERISTICS (continued)

($V_{IN} = +15V$, $V_{EN/UVLO} = +2V$, COMPF = open, $C_{IN} = 1\mu F$, $C_{VCC} = 1\mu F$, $T_A = T_J = -40^\circ C$ to $+125^\circ C$, unless otherwise noted. Typical values are at $T_A = +25^\circ C$.) (Note 2)

PARAMETER	CONDITIONS	MIN	TYP	MAX	UNITS
Flyback/Boost Overcurrent Hiccup Timeout			32		ms
Minimum On-Time			110		ns
SCOMPFB Pullup Current		9	10	11	μA
Slope-Compensation Resistor Range	MAX17497B	30		200	$k\Omega$
Default Slope-Compensation Ramp	SCOMPFB = open		100		mV/ μs
STEP-DOWN REGULATOR					
INB Voltage Range		7		16	V
INB Quiescent Supply Current	$V_{INB} = 16V$, $V_{OUTB} > 3.3V$		200	300	μA
INB UVLO Threshold	Rising	6.2	6.5	6.7	V
	Falling	5.9	6.2	6.4	
High-Side $R_{DS(on)}$	$I_{LXB} = 200mA$		425	800	$m\Omega$
Low-Side $R_{DS(on)}$	$I_{LXB} = 200mA$		225	425	$m\Omega$
Switching Frequency		0.94	1	1.06	MHz
LXB Leakage Current	$V_{LXB} = V_{INB} - 1V$, $V_{LXB} = V_{PGNDB} + 1V$, $T_A = +25^\circ C$		0.1	1	μA
LXB Dead Time	(Note 4)		5		ns
V_{OUTB} Output-Voltage Accuracy	$7V < V_{INB} < 16V$, $50mA < I_{OUT} < 600mA$	3.245	3.3	3.355	V
V_{OUTB} Input Bias Current	$V_{OUTB} = 3.3V$		7	10	μA
Peak Current-Limit Fault Threshold	$V_{OUTB} = 3.1V$	0.9	1.1	1.23	A
Runaway Current-Limit Threshold	$V_{OUTB} < 100mV$	1.05	1.25	1.45	A
Soft-Start Duration Count	$V_{INB} > 7V$		2048		Cycles
Number of Peak Current-Limit Hits Before Hiccup Timeout			8		Hits
Number of Runaway Current-Limit Hits Before Hiccup Timeout			1		Hits
Overcurrent Hiccup Timeout			32,768		Cycles
Minimum On-Time			100		ns
RESETN					
RESETN Output Leakage Current (Off-State)	$V_{RESETN} = 5V$, $T_A = +25^\circ C$	-1		+1	μA
RESETN Output Voltage (On-State)	$I_{RESETN} = 10mA$	0		0.4	V
RESETN Higher Thresholds	EAFN rising	93.5	95	96.5	%
	OUTB rising	93.5	95	96.5	

MAX17497A/MAX17497B

AC-DC and DC-DC Peak-Current-Mode Converters with Integrated Step-Down Regulator

ELECTRICAL CHARACTERISTICS (continued)

($V_{IN} = +15V$, $V_{EN/UVLO} = +2V$, COMPF = open, $C_{IN} = 1\mu F$, $C_{VCC} = 1\mu F$, $T_A = T_J = -40^\circ C$ to $+125^\circ C$, unless otherwise noted. Typical values are at $T_A = +25^\circ C$.) (Note 2)

PARAMETER	CONDITIONS	MIN	TYP	MAX	UNITS
RESETN Lower Thresholds	EAFN falling	90.5	92	93.5	%
	OUTB falling	90.5	92	93.5	
RESETN Delay After EAFN and V_{OUTB} Reach 95% Regulation (MAX17497A/MAX17497B)			4		ms
THERMAL SHUTDOWN					
Thermal Shutdown Threshold	Temperature rising		160		$^\circ C$
Thermal Shutdown Hysteresis			20		$^\circ C$

Note 2: All devices are 100% production tested at $T_A = +25^\circ C$. Limits over temperature are guaranteed by design.

Note 3: The MAX17497A is intended for use in universal input power supplies. The internal clamp circuit at IN is used to prevent the bootstrap capacitor from charging to a voltage beyond the absolute maximum rating of the device when EN/UVLO is low (shutdown mode). Externally limit the current to IN (hence to clamp) to 2mA (max) when EN/UVLO is low.

Note 4: Guarantees cross conduction is avoided and it is not larger than specified max value to guarantee loop-regulation capability.

Typical Operating Characteristics

($V_{IN} = +15V$, $V_{EN/UVLO} = +2V$, COMPF = open, $C_{IN} = 1\mu F$, $C_{VCC} = 1\mu F$, $T_A = T_J = -40^\circ C$ to $+125^\circ C$, unless otherwise noted. Typical values are at $T_A = +25^\circ C$.)

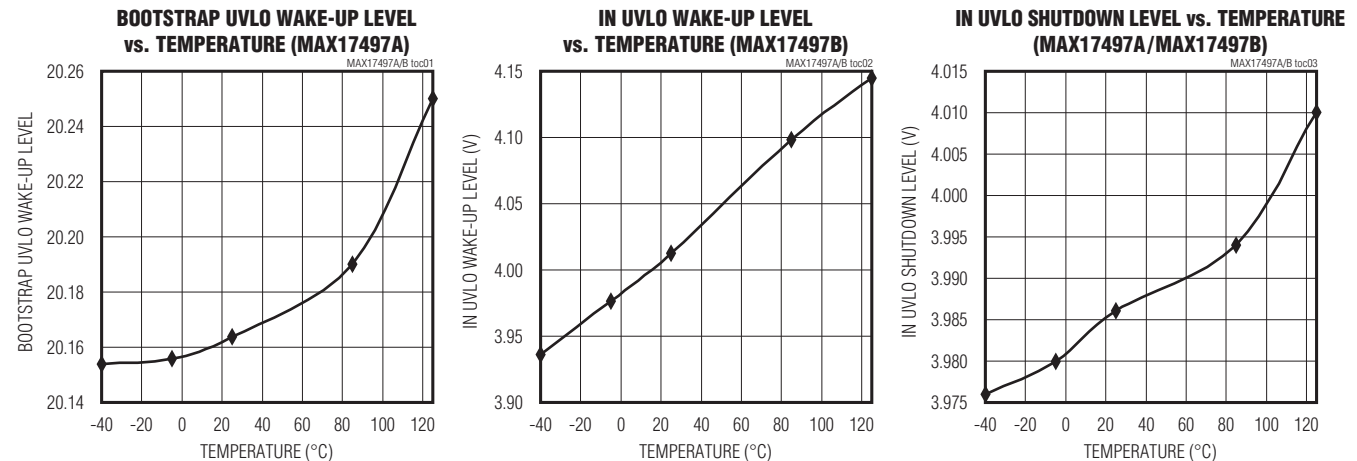

MAX17497A/MAX17497B

AC-DC and DC-DC Peak-Current-Mode Converters with Integrated Step-Down Regulator

Typical Operating Characteristics (continued)

($V_{IN} = +15V$, $V_{EN/UVLO} = +2V$, $COMP_F = \text{open}$, $C_{IN} = 1\mu F$, $C_{VCC} = 1\mu F$, $T_A = T_J = -40^\circ C$ to $+125^\circ C$, unless otherwise noted. Typical values are at $T_A = +25^\circ C$.)

**EN/UVLO RISING LEVEL vs. TEMPERATURE
(MAX17497A/MAX17497B)**

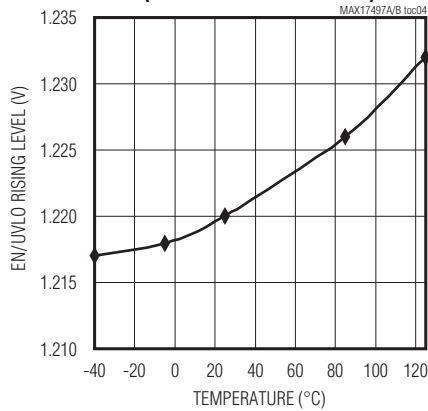

**EN/UVLO FALLING LEVEL vs. TEMPERATURE
(MAX17497A/MAX17497B)**

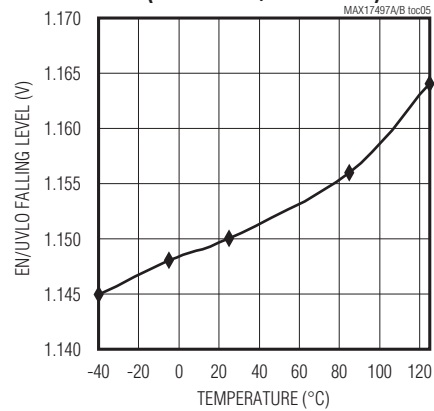

**OVI RISING LEVEL vs. TEMPERATURE
(MAX17497A/MAX17497B)**

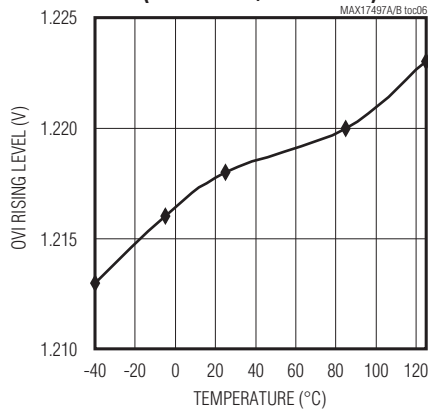

**OVI FALLING LEVEL vs. TEMPERATURE
(MAX17497A/MAX17497B)**

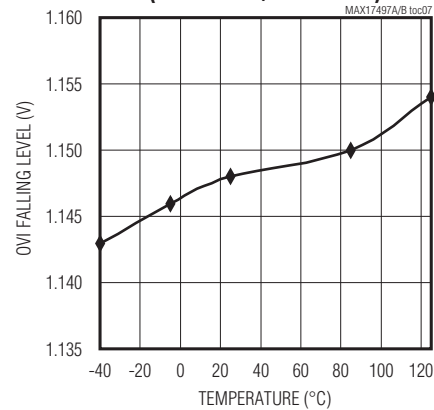

**IN CURRENT UNDER UVLO vs. TEMPERATURE
(MAX17497A/MAX17497B)**

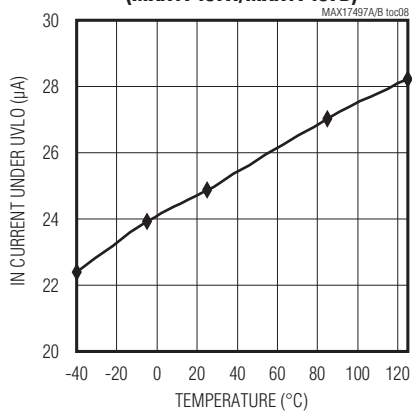

**IN CURRENT DURING SWITCHING
vs. TEMPERATURE**

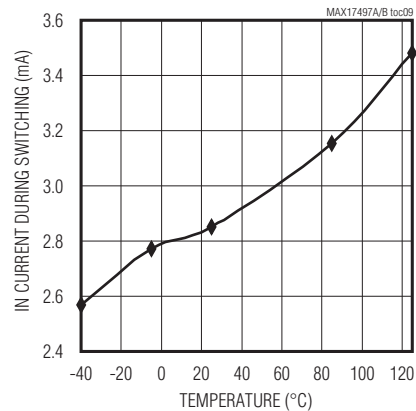

MAX17497A/MAX17497B

AC-DC and DC-DC Peak-Current-Mode Converters with Integrated Step-Down Regulator

Typical Operating Characteristics (continued)

($V_{IN} = +15V$, $V_{EN/UVLO} = +2V$, $COMP_F = open$, $C_{IN} = 1\mu F$, $C_{VCC} = 1\mu F$, $T_A = T_J = -40^\circ C$ to $+125^\circ C$, unless otherwise noted. Typical values are at $T_A = +25^\circ C$.)

LXF AND PRIMARY CURRENT WAVEFORM

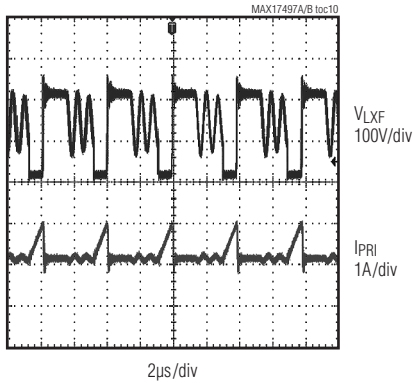

ENABLE STARTUP WAVEFORM (FULL LOAD)

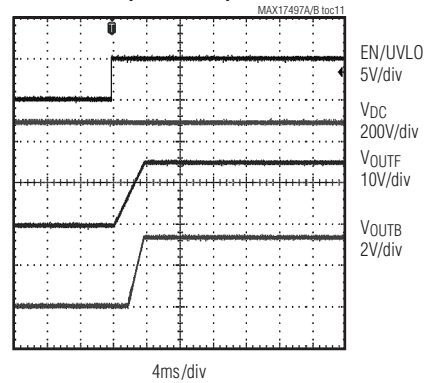

ENABLE SHUTDOWN WAVEFORM (FULL LOAD)

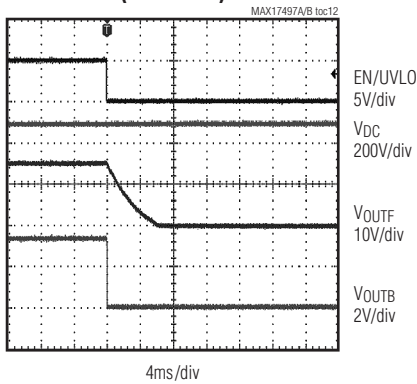

RESETN WAVEFORM

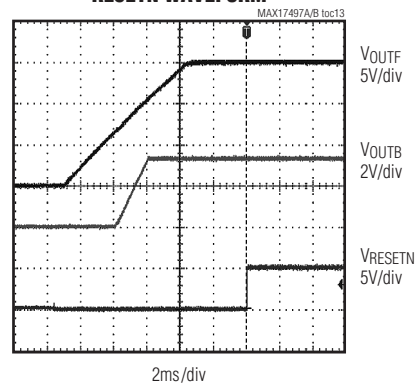

PEAK CURRENT LIMIT (ILIMF) vs. RLIMF AT ROOM TEMPERATURE

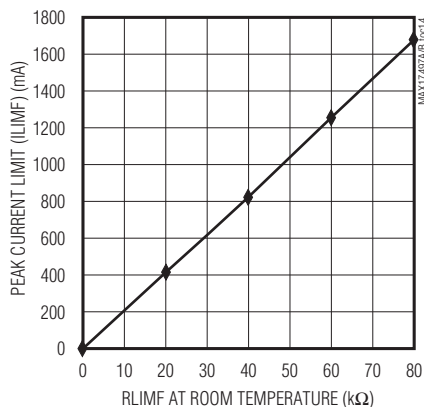

PEAK-CURRENT LIMIT AT RLIMF = 100kΩ vs. TEMPERATURE

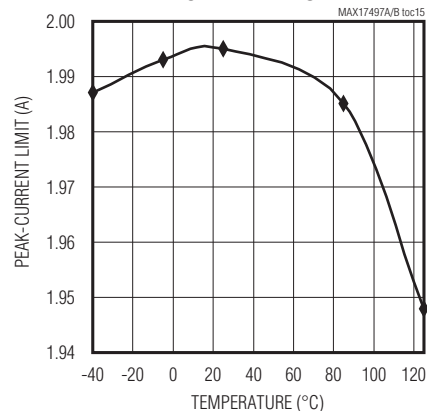

MAX17497A/MAX17497B

AC-DC and DC-DC Peak-Current-Mode Converters with Integrated Step-Down Regulator

Typical Operating Characteristics (continued)

($V_{IN} = +15V$, $V_{EN/UVLO} = +2V$, $COMP_F = open$, $C_{IN} = 1\mu F$, $C_{VCC} = 1\mu F$, $T_A = T_J = -40^\circ C$ to $+125^\circ C$, unless otherwise noted. Typical values are at $T_A = +25^\circ C$.)

TRANSIENT RESPONSE (FLYBACK)

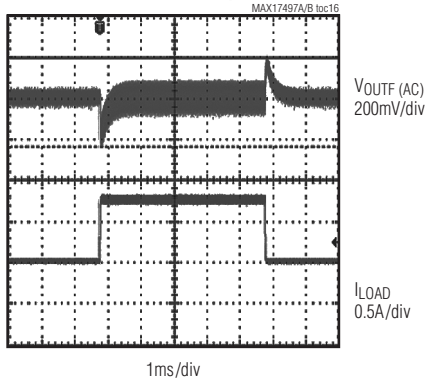

HICCUP OVERCURRENT PROTECTION (FLYBACK REGULATOR)

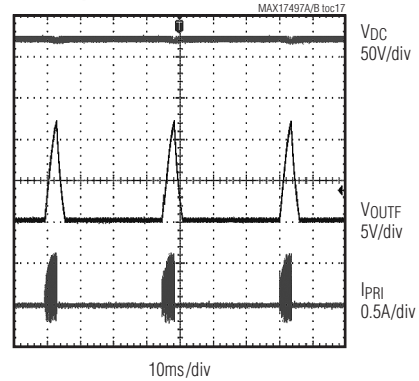

BODE PLOT (FLYBACK REGULATOR)

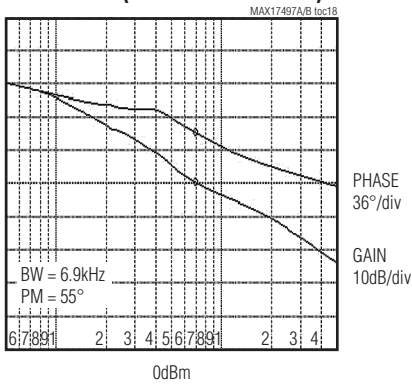

INB WAKE-UP LEVEL vs. TEMPERATURE

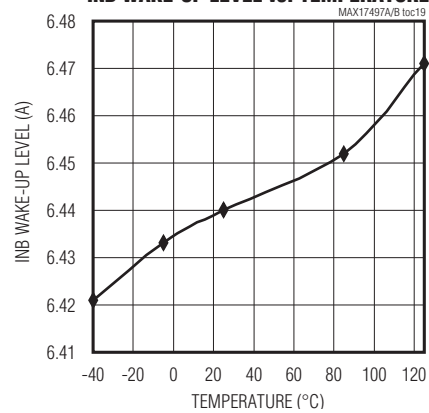

VOUTB vs. TEMPERATURE

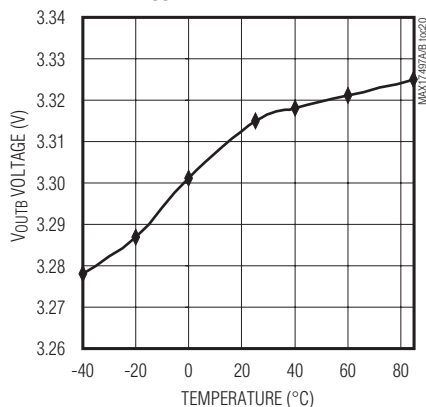

VOUTB vs. INB VOLTAGE

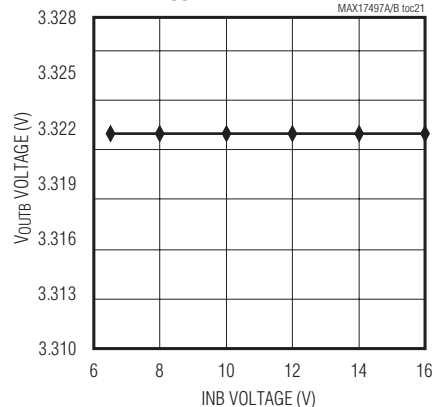

MAX17497A/MAX17497B

AC-DC and DC-DC Peak-Current-Mode Converters with Integrated Step-Down Regulator

Typical Operating Characteristics (continued)

($V_{IN} = +15V$, $V_{EN/UVLO} = +2V$, $COMP_F = \text{open}$, $C_{IN} = 1\mu F$, $C_{VCC} = 1\mu F$, $T_A = T_J = -40^\circ C$ to $+125^\circ C$, unless otherwise noted. Typical values are at $T_A = +25^\circ C$.)

LXB AND INDUCTOR WAVEFORM

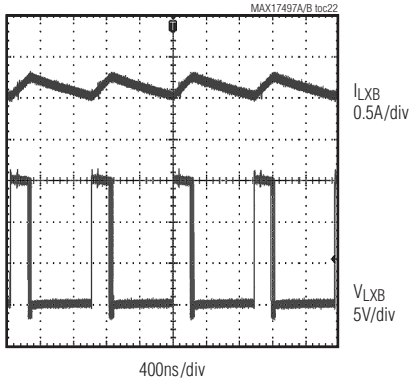

V_{OUTB} vs. LOAD CURRENT

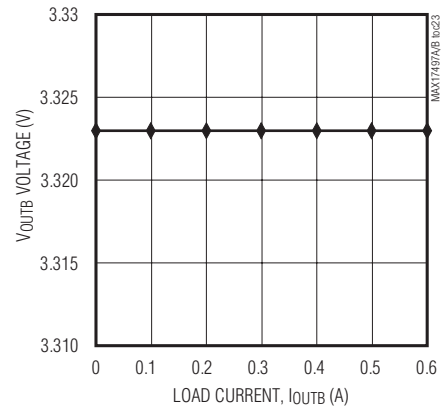

LOAD STEP ON BUCK REGULATOR

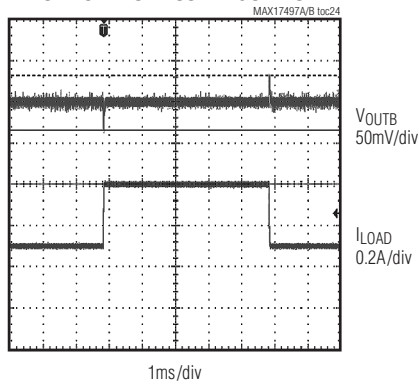

BODE PLOT (BUCK REGULATOR)

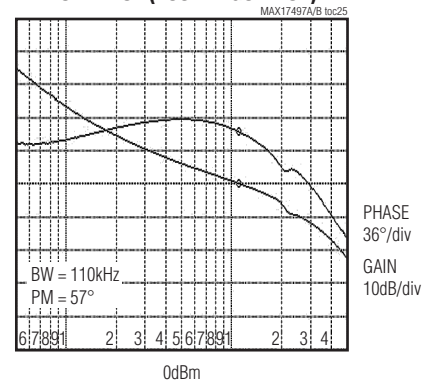

EFFICIENCY GRAPH vs. LOAD CURRENT (FLYBACK REGULATOR)

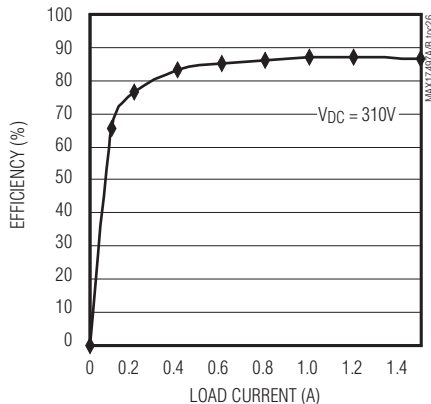

EFFICIENCY vs. LOAD CURRENT (BUCK REGULATOR)

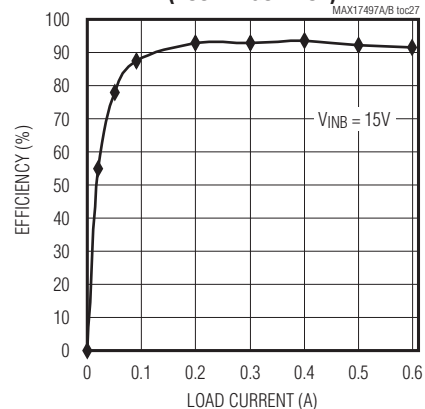

MAX17497A/MAX17497B

AC-DC and DC-DC Peak-Current-Mode Converters with Integrated Step-Down Regulator

Pin Configuration

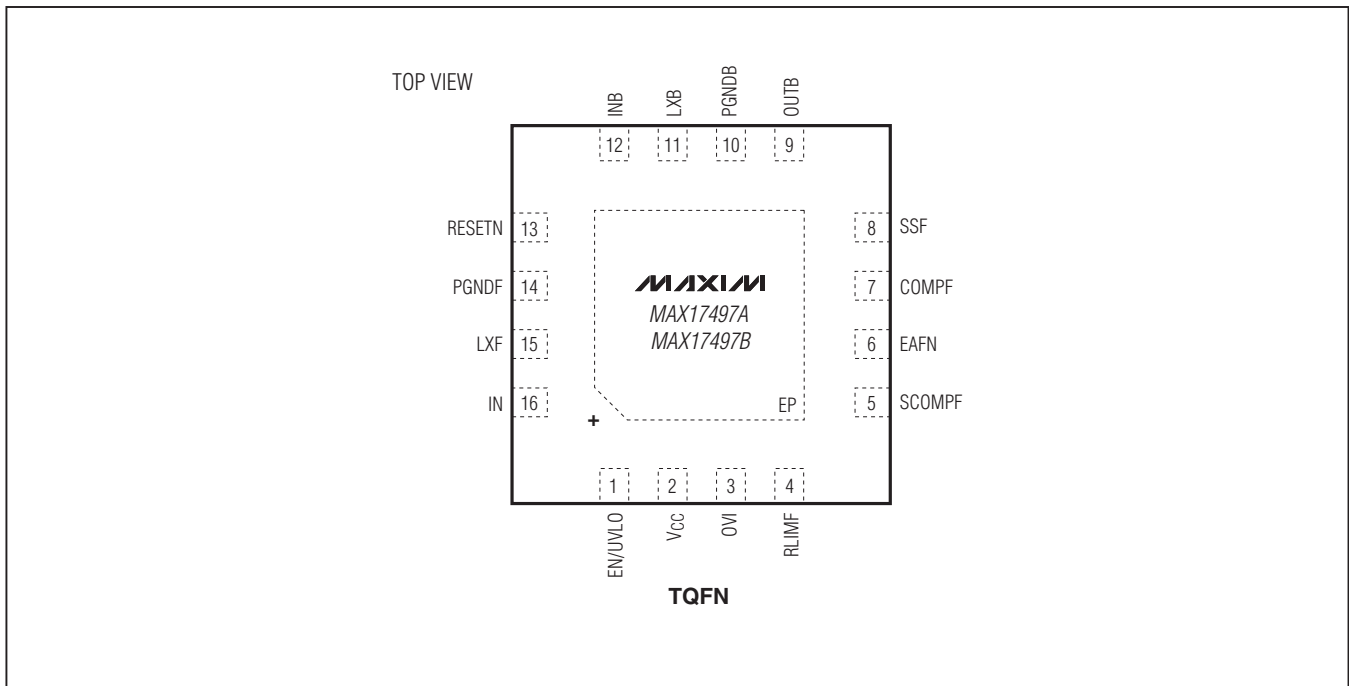

Pin Description

PIN	NAME	FUNCTION
1	EN/UVLO	Enable/Undervoltage-Lockout Pin. Drive to > 1.23V to start the devices. To externally program the UVLO threshold of the input supply, connect a resistor-divider between input supply EN/UVLO and SGND.
2	V _{CC}	Linear Regulator Output. Connect input bypass capacitor of at least 1μF from V _{CC} to SGND as close as possible to the IC.
3	OVI	Overvoltage Comparator Input. Connect a resistor-divider between the input supply (OVI) and SGND to set the input overvoltage threshold.
4	RLIMF	Current-Limit Setting Pin. Connect a resistor between RLIMF and SGND to set the peak-current limit for nonisolated flyback converter. Peak-current limit defaults to 500mA if unconnected.
5	SCOMPf	Slope Compensation Input Pin. Connect a resistor between SCOMPf and SGND to set slope comp ramp. Connect to V _{CC} for minimum slope comp. See the <i>Programming the Slope Compensation for the Flyback/Boost Converter (SCOMPf)</i> section.
6	EAFN	Feedback/Inverting Input of the Error Amplifier for Nonisolated Flyback Converter. Connect to midpoint of resistor-divider from the positive terminal of the output capacitor of the flyback/boost converter to SGND.
7	COMPf	Error-Amplifier Output of Flyback/Boost Converter. Connect the frequency-compensation network between COMPf and SGND. See Figure 9.

MAX17497A/MAX17497B

AC-DC and DC-DC Peak-Current-Mode Converters with Integrated Step-Down Regulator

Pin Description (continued)

PIN	NAME	FUNCTION
8	SSF	Soft-Start Pin for Flyback/Boost Converter. Connect a capacitor from SSF to SGND to set the soft-start time interval.
9	OUTB	Feedback for Step-Down Regulator. Connects OUTB to the positive terminal of the step-down regulator output capacitor.
10	PGNDB	Power Ground for Step-Down Regulator
11	LXB	External Inductor Connection for Step-Down Regulator. Connect to one end of the output inductor. Connect the other end of output inductor to output capacitor.
12	INB	Internal Step-Down Regulator Input. Connect INB to either V_{OUTF} , the output of flyback/boost converter, or directly to the DC input source, as needed in the application. Bypass INB to PGNDB with a 2.2 μ F minimum ceramic capacitor.
13	RESETN	Open-Drain Output. RESETN goes high when both the outputs are within 5% of their regulation point. RESETN goes low when either of the outputs falls below 92% of their regulation value.
14	PGNDF	Power Ground for Flyback/Boost Converter
15	LXF	External Transformer/Inductor Connection for Flyback/Boost Converter
16	IN	Internal Linear Regulator Input. Connect IN to the input-voltage source. Bypass IN to PGNDF with ceramic capacitor of at least 1 μ F.
—	EP	Exposed Pad. Internally connected to SGND. Connect EP to a large copper plane at SGND potential to provide adequate thermal dissipation. Connect EP (SGND) to PGNDF at a single point.

Detailed Description

The MAX17497A is optimized for implementing a nonisolated offline flyback converter with output power of up to 30W and a 3.3V, 600mA power rail using the on-board synchronous step-down regulator. The output voltage of the flyback converter serves as the input supply voltage to the on-board 3.3V integrated synchronous step-down regulator. The outputs of the flyback converter and step-down regulator are regulated with independent feedback loops, thus providing two accurately controlled voltages for the system. If needed, more semi-regulated outputs can be generated using additional secondary windings on the flyback converter transformer. The MAX17497B is optimized for implementing a nonisolated flyback/boost converter up to 15W and a 3.3V, 600mA synchronous step-down regulator in low-voltage DC-DC applications down to 4.5V DC. See the [Figure 1](#) for more information.

Input Voltage Range

The MAX17497A has different rising and falling UVLO thresholds on the IN pin than those of the MAX17497B. The thresholds for the MAX17497A are optimized for implementing power-supply startup schemes typically used for offline AC-DC power supplies. The MAX17497A is therefore well suited for operation from the rectified DC bus in AC-DC power-supply applications typically encountered in electric metering and other low-power industrial power-supply applications. As such, the MAX17497A has no limitation on the maximum input voltage as long as the external components are rated suitably and the maximum operating voltages of the MAX17497A are respected. The MAX17497A can successfully be used in universal input rectified (85V to 265V AC) bus applications, rectified 3-phase DC bus applications, and telecom (36V to 72V DC) applications.

MAX17497A/MAX17497B

AC-DC and DC-DC Peak-Current-Mode Converters with Integrated Step-Down Regulator

The MAX17497B is intended for implementing a nonisolated flyback/boost converter with an on-board 60V rated n-channel MOSFET. The IN pin of the MAX17497B has a maximum operating voltage of 36V. The MAX17497B implements rising and falling thresholds on the IN pin that assume power-supply startup schemes, typical of lower voltage DC-DC applications, down to an input voltage of 4.5V DC. Therefore, flyback/boost converters with a 4.5V to 36V supply voltage range can be implemented with the MAX17497B. See the [Startup Operation](#) section for more details on power-supply startup schemes for both devices. The on-board synchronous step-down regulator is rated for a 16V (max) operating input voltage.

Linear Regulator (V_{CC})

The devices have an internal linear regulator powered from the IN pin. The output of the linear regulator is connected to the V_{CC} pin and should be decoupled with a 1 μ F capacitor to ground for stable operation. The V_{CC} regulator output supplies the operating current for the devices. The maximum operating voltage of the IN pin is 29V for the MAX17497A and 36V for the MAX17497B.

Configuring the Power Stage (LXF)

The devices use an internal nMOSFET to implement internal current sensing for current-mode control and overcurrent protection of the flyback/boost converter. To facilitate this, the drain of the internal nMOSFET is connected to the source of the external MOSFET in the MAX17497A application. The gate of the external MOSFET is connected to the IN pin. Ensure by design that the IN pin voltage does not exceed the maximum operating gate-voltage rating of the external MOSFET. The external MOSFET gate-source voltage is controlled by the switching action of the internal nMOSFET, while also sensing the source current of the external MOSFET. In the MAX17497B application, the LXF pin is directly connected to either the flyback transformer primary winding or to the boost-converter inductor.

Maximum Duty Cycle

The MAX17497A operates at a maximum duty cycle of 49%. The MAX17497B offers a maximum duty cycle of 93% to implement both flyback and boost converters

involving large input-to-output voltage ratios in DC-DC applications. The on-board synchronous step-down regulator has a maximum duty cycle of 85% and is internally compensated for stable operation.

RESETN Power-Good Signal

The devices include a RESETN signal that serves as a power-good signal to the system. RESETN is an open-drain signal and requires a pullup resistor to the preferred supply voltage. The RESETN signal monitors both the flyback/boost output and the synchronous step-down regulator output, pulling high when both outputs are at 95% (typ) of their regulation values. The RESETN signal pulls low when either of the outputs fall below 92% (typ) of their regulation values.

Sequencing

The MAX17497A is typically configured such that the output of the flyback converter serves as the input source to the integrated synchronous step-down regulator. Because the synchronous step-down regulator has a 6.5V input UVLO threshold, the 3.3V output always comes up after the output of the flyback converter. [Figure 2](#) shows the sequencing of the MAX17497A outputs configured as described above. The sequencing for the devices is identical when the MAX17497B is configured as either a flyback or boost output generating the input supply voltage for the integrated step-down regulator. The step-down regulator can also operate from an independent 7V to 16V DC supply. In this case, the step-down regulator starts up when its INB pin voltage exceeds 7V, provided that the EN/UVLO pin voltage is greater than 1.23V (typ).

Soft-Start

The devices implement soft-start operation for the flyback/boost converter, as well as the synchronous step-down regulator. A capacitor connected to the SSF pin programs the soft-start period for the flyback/boost converter, while the step-down regulator has a fixed internal digital soft-start scheme. The step-down regulator includes soft-start duration of 2ms. See the [Programming the Soft-Start of the Flyback/Boost Converter \(SSF\)](#) section for more details on selection of the SSF capacitor.

MAX17497A/MAX17497B

AC-DC and DC-DC Peak-Current-Mode Converters with Integrated Step-Down Regulator

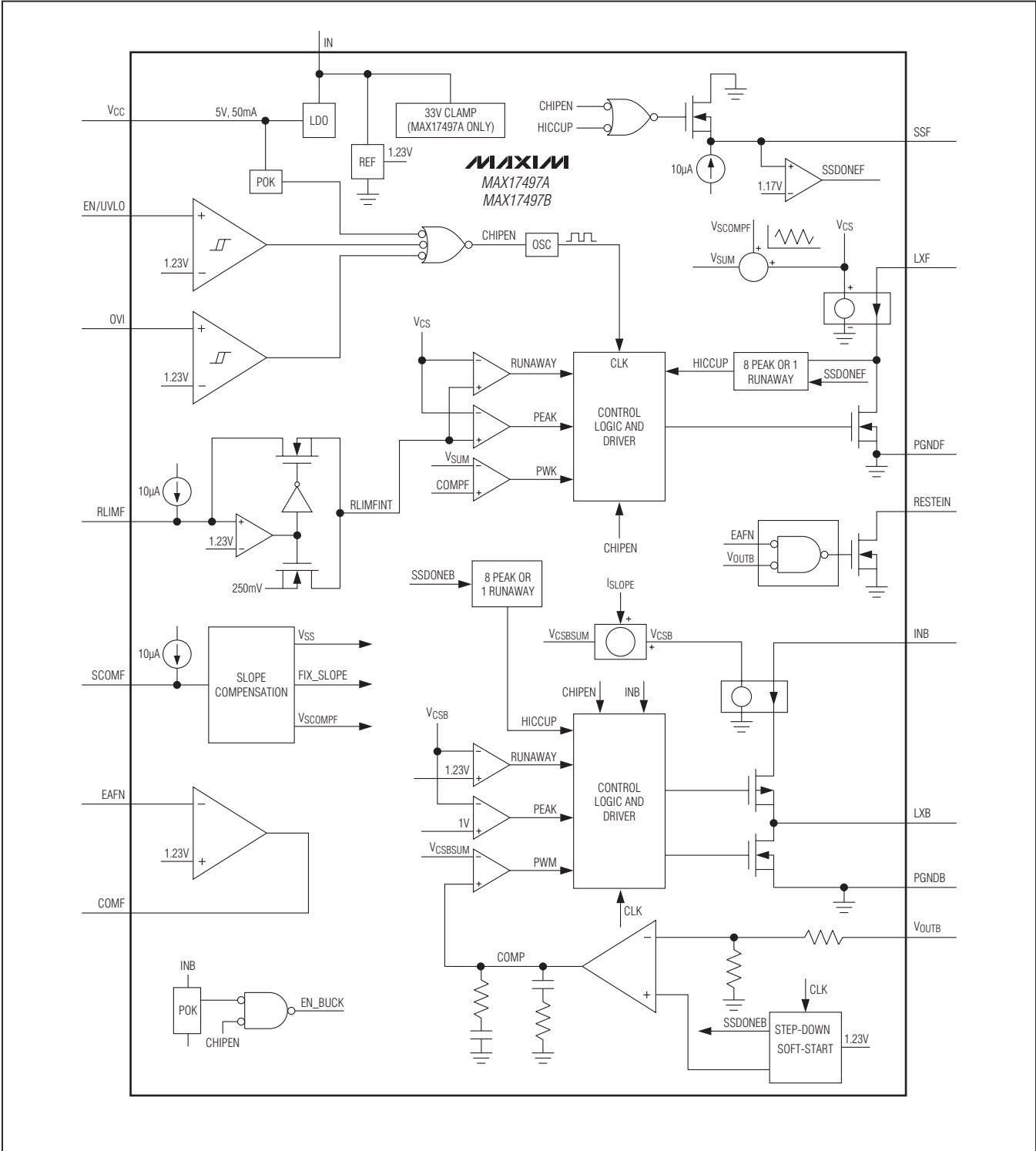

Figure 1. MAX17497A/MAX17497B Block Diagram

AC-DC and DC-DC Peak-Current-Mode Converters with Integrated Step-Down Regulator

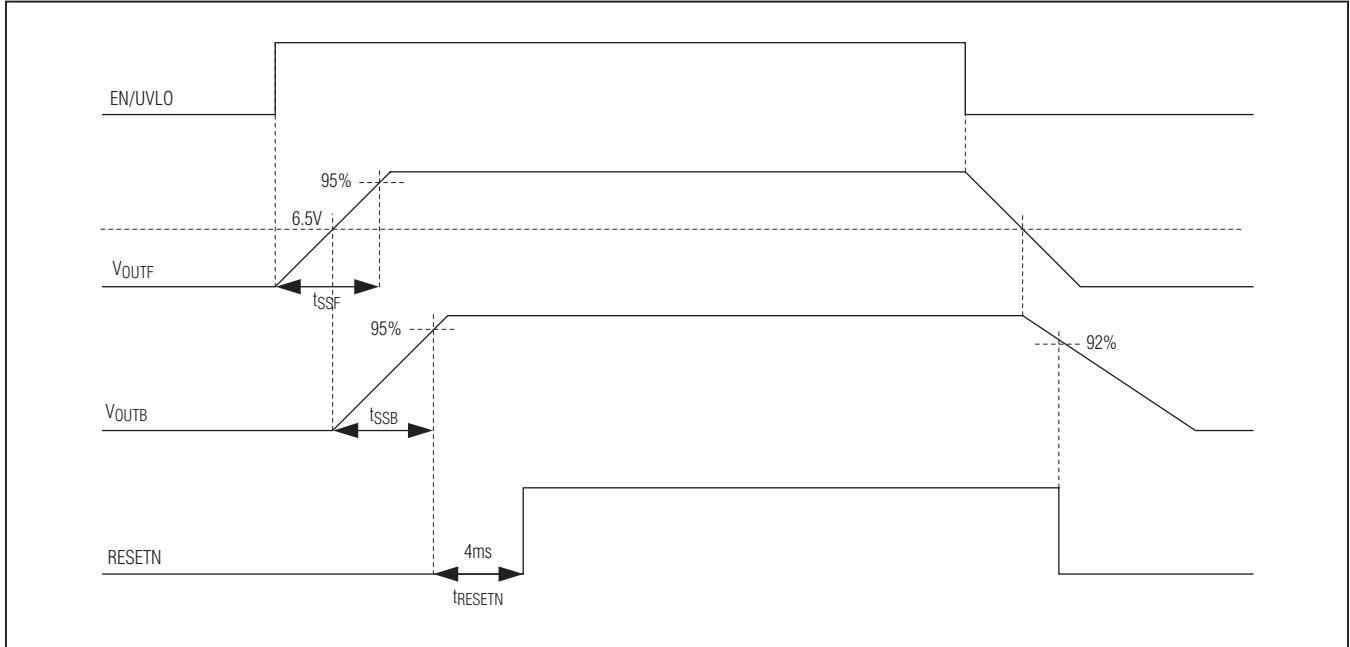

Figure 2. Sequencing of MAX17497A/MAX17497B Output Voltage Rails

Spread-Spectrum Factory Option

For EMI-sensitive applications, a spread-spectrum-enabled version of the device can be requested from the factory. The frequency-dithering feature modulates the switching frequency by $\pm 10\%$ at a rate of 1/16 the switching frequency. This spread-spectrum-modulation technique spreads the energy of switching-frequency harmonics over a wider band while reducing their peaks, helping to meet stringent EMI goals.

Applications Information

Startup Voltage and Input Overvoltage-Protection Setting (EN/UVLO, OVI)

The devices' EN/UVLO pin serves as an enable/disable input, as well as an accurate programmable input UVLO pin. The devices do not commence startup operations unless the EN/UVLO pin voltage exceeds 1.23V (typ). The devices turn off if the EN/UVLO pin voltage falls below 1.17V (typ). A resistor-divider from the input DC bus to ground can be used to divide down and apply a fraction of the input DC voltage (V_{DC}) to the EN/UVLO pin. The values of the resistor-divider can be selected such that the EN/UVLO pin voltage exceeds the 1.23V (typ) turn-on threshold at the desired input DC bus voltage. The same resistor-divider can be modified with an

additional resistor (R_{OVI}) to implement input overvoltage protection in addition to the EN/UVLO functionality, as shown in Figure 3. When voltage at the OVI pin exceeds 1.23V (typ), the devices stop switching and resume switching operations only if voltage at the OVI pin falls below 1.17V (typ). For given values of startup DC input voltage (V_{START}), and input overvoltage-protection voltage (V_{OVI}), the resistor values for the divider can be calculated as follows, assuming a 24.9k Ω resistor for R_{OVI} :

$$R_{EN} = R_{OVI} \times \left[\frac{V_{OVI}}{V_{START}} - 1 \right] \text{ k}\Omega$$

where R_{OVI} is in k Ω and V_{START} and V_{OVI} are in volts.

$$R_{SUM} = [R_{OVI} + R_{EN}] \times \left[\frac{V_{START}}{1.23} - 1 \right] \text{ k}\Omega$$

where R_{EN} and R_{OVI} is in k Ω and V_{OVI} is in volts. R_{SUM} may need to be implemented as equal multiple resistors in series (R_{DC1} , R_{DC2} , R_{DC3}) such that voltage across each resistor is limited to its maximum operating voltage.

$$R_{DC1} = R_{DC2} = R_{DC3} = \frac{R_{SUM}}{3} \text{ k}\Omega$$

AC-DC and DC-DC Peak-Current-Mode Converters with Integrated Step-Down Regulator

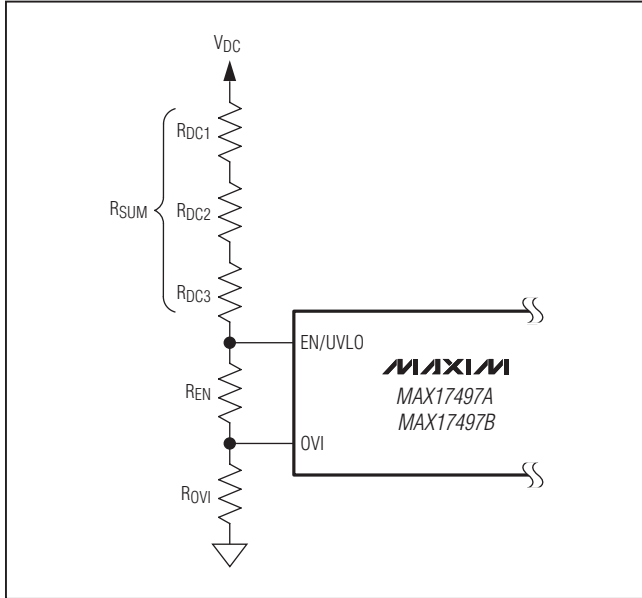

Figure 3. Programming EN/UVLO and OVI

Startup Operation

The MAX17497A is optimized for implementing offline flyback converters. A cost-effective RC startup circuit is used in offline applications. In this startup method, when the input DC voltage is applied, the startup resistor (R_{START}) charges the startup capacitor (C_{START}), causing the voltage at the IN pin to increase towards the rising IN UVLO threshold (20V typ). During this time, the MAX17497A draws a low startup current of 20 μ A (typ) through R_{START} . When the voltage at IN reaches the rising IN UVLO threshold, the MAX17497A commences switching operations and drives the internal nMOSFET whose drain is connected to the LXF pin. In this condition, the MAX17497A draws 2.5mA current in from C_{START} , in addition to the current required to switch the gate of the external nMOSFET (Q1). Since this current cannot be supported by the current through R_{START} , the voltage on C_{START} starts to drop. When suitably configured as show in [Figure 4](#), the external nMOSFET is switched by the LXF pin and the flyback converter generates an output voltage (V_{OUTF}) bootstrapped to the IN pin through the diode (D2). If V_{OUTF} exceeds the sum of 6V and the drop across D2 before the voltage on C_{START} falls below 5V, then the IN voltage is sustained by V_{OUTF} , allowing the MAX17497A to continue operating with energy from V_{OUTF} . The large hysteresis (15V typ) of the MAX17497A allows for a small startup capacitor (C_{START}). The low startup

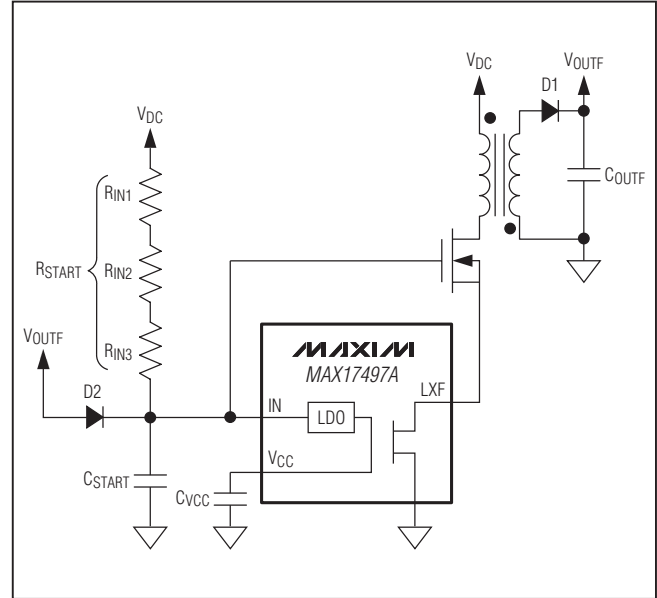

Figure 4. MAX17497A RC-Based Startup Circuit

current (20 μ A typ) allows the use of a large startup resistor (R_{START}), thus reducing power dissipation at higher DC bus voltages. R_{START} may need to be implemented as equal, multiple resistors in series (R_{IN1} , R_{IN2} and R_{IN3}) to share the applied high DC voltage in offline applications, such that the voltage across each resistor is limited to the maximum continuous operating-voltage rating. R_{START} and C_{START} can be calculated as:

$$C_{START} = \left[I_{IN} + \left(\frac{Q_{GATE} \times f_{sw}}{10^6} \right) \right] \times \frac{t_{SSF}}{10} \mu F$$

where I_{IN} is the supply current drawn at the IN pin in mA, Q_{GATE} is the gate charge of the external MOSFET used in nC, f_{sw} is the switching frequency of the converter in Hz, and t_{SSF} is the soft-start time programmed for the flyback converter in ms (see the [Programming the Soft-Start of the Flyback/Boost Converter \(SSF\)](#) section).

$$R_{START} = \frac{(V_{START} - 10) \times 50}{[1 + C_{START}]} k\Omega$$

where C_{START} is the startup capacitor in μ F.

For designs that cannot accept power dissipation in the startup resistors at high DC input voltages in offline applications, the startup circuit can be set up with a current source instead of a startup resistor, as shown in [Figure 5](#).

MAX17497A/MAX17497B

AC-DC and DC-DC Peak-Current-Mode Converters with Integrated Step-Down Regulator

The startup capacitor (C_{START}) can be calculated as follows:

$$C_{START} = \left[I_{IN} + \left(\frac{Q_{GATE} \times f_{sw}}{10^6} \right) \right] \times \frac{t_{SSF}}{10} \mu F$$

where I_{IN} is the supply current drawn at the IN pin in mA, Q_{GATE} is the gate charge of the external MOSFET used in nC, f_{sw} is the switching frequency of the converter in kHz, and t_{SSF} is the soft-start time programmed for the flyback converter in ms.

Resistors R_{START} and R_{ISRC} can be calculated as:

$$R_{START} = \frac{V_{START}}{10} M\Omega$$

$$R_{ISRC} = \frac{V_{BEQ1}}{70} M\Omega$$

The IN UVLO rising threshold of the MAX17497B is set to 3.9V with hysteresis of 200mV, optimized for low-voltage DC-DC applications down to 4.5V. For applications where the input DC voltage is low enough (e.g., 4.5V to 5.5V DC) so the power loss incurred to supply the operating current of the MAX17497B can be tolerated, the IN pin is directly connected to the DC input (Figure 6). For higher DC input voltages (e.g., 16V to 32V DC), a startup circuit (Figure 7) can be used to minimize power dissipation in the startup circuit. In this startup scheme, the transistor (Q1) supplies the switching current until a bias winding N_B comes up. The resistor (R_Z) can be calculated as:

$$R_Z = 9 \times (V_{INMIN} - 6.3) k\Omega$$

where V_{INMIN} is the minimum input DC voltage.

Programming the Soft-Start of the Flyback/Boost Converter (SSF)

The devices' soft-start period of the flyback/boost converter can be programmed by selecting the value of the capacitor connected from the SSF pin to GND. The capacitor (C_{SSF}) can be calculated as:

$$C_{SSF} = 8.13 \times t_{SSF} nF$$

where t_{SSF} is expressed in ms.

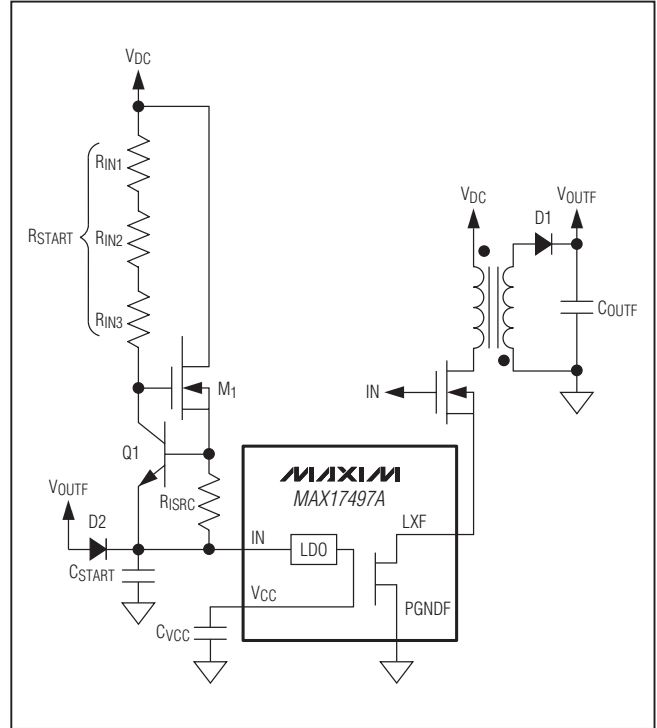

Figure 5. MAX17497A Current-Source-Based Startup Circuit

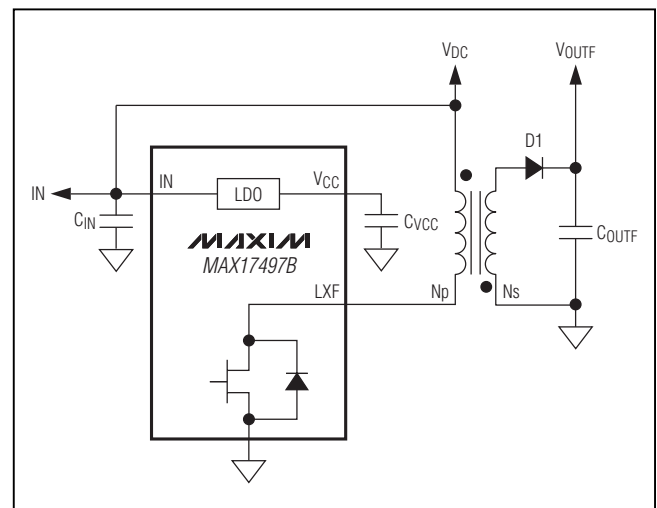

Figure 6. MAX17497B Typical Startup Circuit with IN Connected Directly to DC Input

AC-DC and DC-DC Peak-Current-Mode Converters with Integrated Step-Down Regulator

Programming the Output Voltage of the Flyback/Boost Converter (SSF)

Set the output voltage of the flyback/boost converter by selecting the correct values for the resistor-divider connected from the flyback/boost output to ground (V_{OUTF}) with the midpoint of the divider connected to the EAFN pin (Figure 8). With R_B selected in the range of $20k\Omega$ to $50k\Omega$, R_U can be calculated as:

$$R_U = R_B \times \left[\frac{V_{OUTF}}{1.23} - 1 \right] k\Omega$$

where R_B is in $k\Omega$.

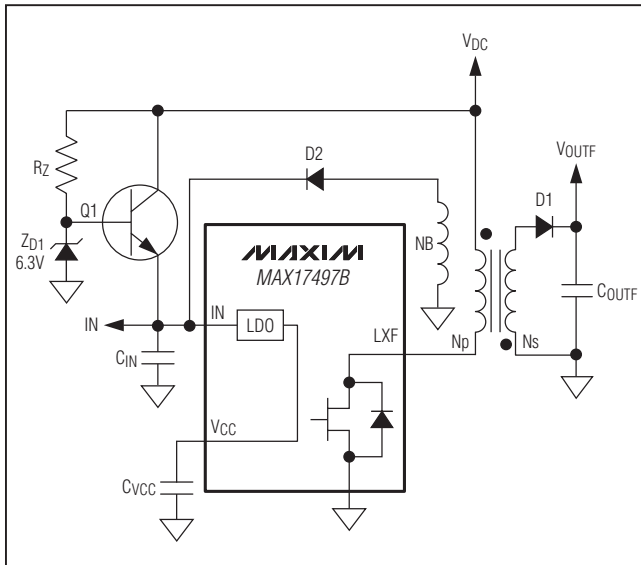

Figure 7. MAX17497B Typical Startup Circuit with Bias Winding to Turn Off Q1 and Reduce Power Dissipation

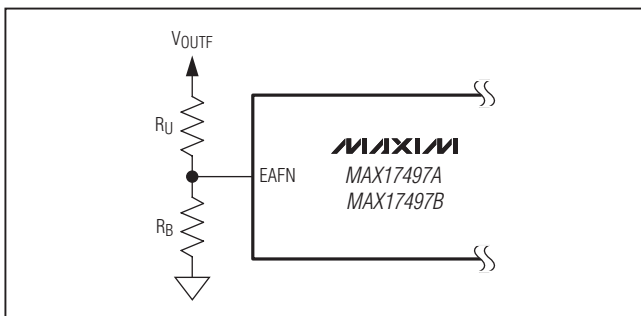

Figure 8. Programming the Output Voltage of the Flyback/Boost Converter

Programming the Current Limit of the Flyback/Boost Converter (RLIMF)

The devices include a robust overcurrent-protection scheme that protects them during overload and short-circuit conditions. For the flyback/boost converter, the devices include a cycle-by-cycle peak current limit that turns off the driver whenever the current into the LXF pin exceeds an internal limit programmed by the resistor connected from the RLIMF pin to ground. The devices include a runaway current limit that protects them during high-input voltage and short-circuit conditions when there is insufficient output voltage available to restore the inductor current built up during the on-period of the flyback/boost converter. Either eight consecutive occurrences of the peak current-limit event or one occurrence of the runaway current limit trigger a hiccup mode, protecting the converter by immediately suspending switching for a period of time (t_{RSTART}). This allows the overload current to decay due to power loss in the converter resistances, load, and the output diode of the flyback/boost converter before soft-start is attempted again. The RLIMF resistor for a desired current limit (I_{PK}) can be calculated as:

$$R_{LIMF} = 50 \times I_{PK} k\Omega$$

where I_{PK} is expressed in amperes.

For a given peak-current-limit setting, the runaway current limit is typically 20% higher. The peak current-limit-triggered hiccup operation is disabled until the end of soft-start, while the runaway current-limit-triggered hiccup operation is always enabled.

Programming the Slope Compensation for the Flyback/Boost Converter (SCOMP)

Since the MAX17497A operates at a maximum duty cycle of 49%, in theory it does not require slope compensation to prevent subharmonic instability that occurs naturally in continuous peak-current-mode controlled converters operating at duty cycles greater than 50%. In practice, the MAX17497A requires a minimum amount of slope compensation to provide stable, jitter-free operation. The MAX17497A allows the user to program this default value of slope compensation simply by connecting the RLIMF pin to V_{CC} . It is recommended that discontinuous-mode designs also use this minimum amount of slope compensation to provide noise immunity and jitter-free operation.

AC-DC and DC-DC Peak-Current-Mode Converters with Integrated Step-Down Regulator

The MAX17497A flyback/boost converter can be designed to operate in discontinuous mode or to enter into continuous-conduction mode at a specific heavy-load condition for a given DC input voltage. In continuous-conduction mode, the flyback/boost converter needs slope compensation to avoid subharmonic instability that occurs naturally over all specified load and line conditions in peak-current-mode-controlled converters operating at duty cycles greater than 50%. A minimum amount of slope signal is added to the sensed current signal even for converters operating below 50% duty cycles to provide stable, jitter-free operation. The SCOMPF pin allows the user to program the necessary slope compensation by setting the value of the R_{SCOMPF} resistor connected from the SCOMPF pin to ground:

$$R_{SCOMPF} = 0.1 S_E \text{ k}\Omega$$

where the slope (S_E) is expressed in volts per microsecond.

Step-Down Overcurrent Protection

The devices' step-down regulator includes a robust overcurrent-protection scheme that protects them during overload and short-circuit conditions. A cycle-by-cycle peak current limit turns off the high-side pMOSFET switch whenever the high-side switch current exceeds an internal limit of 800mA. A runaway current limit on the high-side switch current at 1A (typ) protects the device under high input-voltage short-circuit conditions when there is insufficient output voltage available to restore the inductor current built up during the on period of the step-down regulator. Eight consecutive occurrences of the peak current-limit event or one occurrence of the runaway current limit trigger a hiccup mode to protect the converter by immediately suspending switching for a period of time (t_{RSTARTB}). This allows the overload current to decay, due to power loss in the converter resistances, and load before soft-start is attempted again.

Error Amplifier, Loop Compensation, and Power-Stage Design of the Flyback/Boost Converter

The devices' flyback/boost converter requires that proper loop compensation be applied to the error-amplifier output to achieve stable operation. The goal of the compensator design is to achieve the desired closed-loop bandwidth and sufficient phase margin at the crossover frequency of the open-loop gain-transfer function of the converter. The error amplifier included in the devices is a

transconductance amplifier. The compensation network used to apply the necessary loop compensation is shown in [Figure 9](#).

The flyback/boost converter can be used to implement the following converters and operating modes:

- Nonisolated flyback converter in discontinuous-conduction mode (DCM flyback)
- Nonisolated flyback converter in continuous-conduction mode (CCM flyback)
- Boost converter in discontinuous-conduction mode (DCM boost)
- Boost converter in continuous-conduction mode (CCM boost)

Calculations for loop-compensation values (R_Z, C_Z, and C_P) for these converter types, and design procedures for power-stage components, are detailed in the following sections.

DCM Flyback

Primary Inductance Selection

In a DCM flyback converter, the energy stored in the primary inductance of the flyback transformer is ideally delivered entirely to the output. The maximum primary-inductance value for which the converter remains in discontinuous mode at all operating conditions can be calculated as:

$$L_{PRIMAX} \leq \frac{(V_{INMIN} \times D_{MAX})^2 \times 0.4}{(V_{OUTF} + V_D) \times I_{OUTF} \times f_{SW}}$$

where D_{MAX} is 0.35 for the MAX17497A and 0.7 for the MAX17497B, V_D is the forward-voltage drop of the output rectifier diode on the secondary side, and f_{SW} is the switching frequency of the power converter. Choose the primary inductance value to be less than L_{PRIMAX}.

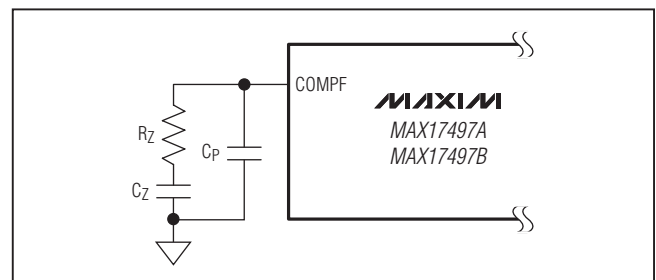

Figure 9. Programming the Output Voltage of the Flyback/Boost Converter

AC-DC and DC-DC Peak-Current-Mode Converters with Integrated Step-Down Regulator

Duty-Cycle Calculation

The accurate value of the duty cycle (D_{NEW}) for the selected primary inductance L_{PRI} can be calculated using the following equation:

$$D_{NEW} = \frac{\sqrt{2.5 \times L_{PRI} \times (V_{OUTF} + V_D) \times I_{OUTF} \times f_{SW}}}{V_{INMIN}}$$

Turns Ratio Calculation (N_s/N_p)

Transformer turns ratio ($K = N_s/N_p$) can be calculated as:

$$K = \frac{(V_{OUTF} + V_D) \times (1 - D_{MAX})}{V_{INMIN} \times D_{MAX}}$$

Peak/RMS Current Calculation

RMS current values in the primary and secondary are needed by the transformer manufacturer to design the wire diameter for the different windings. Peak current calculations are useful in setting the current limit. Use the following equations to calculate the primary and secondary peak and RMS currents:

Maximum primary peak current:

$$I_{PRIPEAK} = \frac{V_{INMIN} \times D_{NEW}}{L_{PRI} \times f_{SW}}$$

Maximum primary RMS current:

$$I_{PRI RMS} = I_{PRIPEAK} \times \sqrt{\frac{D_{NEW}}{3}}$$

Maximum secondary RMS current:

$$I_{SECPEAK} = \frac{I_{PRIPEAK}}{K}$$

Maximum secondary peak current:

$$I_{SECRMS} = I_{PRIPEAK} \times \sqrt{\frac{I_{SECPEAK} \times L_{PRI} \times f_{SW}}{3(V_{OUTF} \times V_D)}}$$

For current-limit setting, the peak current can be calculated as:

$$I_{LIMF} = I_{PRIPEAK} \times 1.2$$

Primary Snubber Selection

Ideally, the external nMOSFET experiences a drain-source-voltage stress equal to the sum of the input voltage and the reflected voltage across the primary winding during the off period of the nMOSFET. In practice,

parasitic inductances and capacitors in the circuit, such as leakage inductance of the flyback transformer, cause voltage overshoot and ringing. Snubber circuits are used to limit the voltage overshoots to safe levels within the voltage rating of the external nMOSFET. The snubber capacitor can be calculated using the following equation:

$$C_{SNUB} = \frac{2 \times L_{LK} \times I_{PRIPEAK}^2 \times K^2}{V_{OUTF}^2}$$

where L_{LK} is the leakage inductance obtained from the transformer specifications (usually 1% to 2% of the primary inductance).

The power dissipated in the snubber resistor is calculated using the following equation:

$$P_{SNUB} = 0.833 \times L_{LK} \times I_{PRIPEAK}^2 \times f_{SW}$$

The snubber resistor can be calculated based on the following equation:

$$R_{SNUB} = \frac{6.25 \times V_{OUTF}^2}{P_{SNUB} \times K^2}$$

The voltage rating of the snubber diode is:

$$V_{DSNUB} = V_{INMAX} + \left(2.5 \times \frac{V_{OUTF}}{K} \right)$$

Output-Capacitor Selection

X7R ceramic output capacitors are preferred in industrial applications due to their stability over temperature. The output capacitor is usually sized to support a step load of 50% of the maximum output current in the application so that the output-voltage deviation is contained to 3% of the output-voltage change. The output capacitance can be calculated as:

$$C_{OUTF} = \frac{I_{STEP} \times t_{RESPONSE}}{\Delta V_{OUTF}}$$

$$t_{RESPONSE} \cong \left(\frac{0.33}{f_C} + \frac{1}{f_{SW}} \right)$$

where I_{STEP} is the load step, $t_{RESPONSE}$ is the response time of the controller, ΔV_{OUTF} is the allowable output voltage deviation, and f_C is the target closed-loop crossover frequency. f_C is chosen to be 1/10 of the switching frequency (f_{SW}). For the flyback converter, the output capacitor supplies the load current when the main switch

AC-DC and DC-DC Peak-Current-Mode Converters with Integrated Step-Down Regulator

is on, and the output-voltage ripple is therefore a function of load current and duty cycle. Use the following equation to calculate the output-capacitor ripple:

$$\Delta V_{COUTF} = \frac{D_{NEW} \times [I_{PRIPEAK} - [K \times I_{OUTF}]]^2}{2 \times I_{PRIPEAK} \times f_{SW} \times C_{OUTF}}$$

where I_{OUTF} is the load current and D_{NEW} is the duty cycle at minimum input voltage.

Input-Capacitor Selection

The MAX17497A is optimized for implementing offline AC-DC converters. In such applications, the input capacitor must be selected based either on the ripple due to the rectified line voltage or on hold-up time requirements. Hold-up time can be defined as the time period over which the power supply should regulate its output voltage from the instant the AC power fails. The MAX17497B is useful for implementing low-voltage DC-DC applications where the switching-frequency ripple must be used to calculate the input capacitor. In both cases, the capacitor must be sized to meet RMS current requirements for reliable operation.

Capacitor Selection Based on Switching Ripple (MAX17497B): For DC-DC applications, X7R ceramic capacitors are recommended due to their stability over the operating temperature range. The ESR and ESL of a ceramic capacitor are relatively low, so the ripple voltage is dominated by the capacitive component. For the flyback converter, the input capacitor supplies the current when the main switch is on. The following equation calculates the input capacitor for a specified peak-to-peak input switching-ripple voltage (V_{IN_RIP}):

$$C_{IN} = \frac{D_{NEW} \times I_{PRIPEAK} [1 - (0.5 \times D_{NEW})]^2}{2 \times f_{SW} \times V_{IN_RIP}}$$

Capacitor Selection Based on Rectified Line Voltage Ripple (MAX17497A): For the flyback converter, the input capacitor supplies the input current when the diode rectifier is off. The voltage discharge (V_{IN_RIP}), due to the input average current, should be within the limits specified:

$$C_{IN} = \frac{0.5 \times I_{PRIPEAK} \times D_{NEW}}{f_{RIPPLE} \times V_{IN_RIP}}$$

where f_{RIPPLE} , the input AC ripple frequency equal to the supply frequency for half-wave rectification, is two times the AC supply frequency for full-wave rectification.

Capacitor Selection Based on Hold-Up Time Requirements (MAX17497A): For a given output power (P_{HOLDUP}) that needs to be delivered during hold-up time (t_{HOLDUP}), DC bus voltage at which the AC supply fails (V_{INFAIL}), and the minimum DC bus voltage at which the converter can regulate the output voltages (V_{INMIN}), the input capacitor (C_{IN}) is estimated as:

$$C_{IN} = \frac{3 \times P_{HOLDUP} \times t_{HOLDUP}}{(V_{INFAIL}^2 - V_{INMIN}^2)}$$

The input capacitor RMS current can be calculated as follows:

$$I_{INCRMS} = \frac{0.6 \times V_{INMIN} \times D_{MAX}^2}{f_{SW} \times L_{PRI}}$$

External MOSFET Selection

MOSFET selection criteria includes the maximum drain voltage, peak/RMS current in the primary, and the maximum allowable power dissipation of the package without exceeding the junction temperature limits. The voltage seen by the MOSFET drain is the sum of the input voltage, the reflected secondary voltage on the transformer primary, and the leakage inductance spike. The MOSFET's absolute maximum V_{DS} rating must be higher than the worst-case drain voltage:

$$V_{DSMAX} = V_{INMAX} + \left[\left(\frac{V_{OUTF} + V_D}{K} \right) \times 2.5 \right]$$

The drain-current rating of the external MOSFET is selected to be greater than the worst-case peak current-limit setting.

Secondary Diode Selection

Secondary diode-selection criteria includes the maximum reverse voltage, average current in the secondary, reverse recovery time, junction capacitance, and the maximum allowable power dissipation of the package. The voltage stress on the diode is the sum of the output voltage and the reflected primary voltage.

The maximum operating reverse-voltage rating must be higher than the worst-case reverse voltage:

$$V_{SECDIODE} = 1.25 \times (K \times V_{INMAX} + V_{OUTF})$$

The current rating of the secondary diode should be selected such that the power loss in the diode (given as the product of forward-voltage drop and the average

AC-DC and DC-DC Peak-Current-Mode Converters with Integrated Step-Down Regulator

diode current) should be low enough to ensure that the junction temperature is within limits. This necessitates the diode-current rating be in the order of $2 \times I_{OUTF}$ to $3 \times I_{OUTF}$. Select fast-recovery diodes with a recovery time less than 50ns, or Schottky diodes with low junction capacitance.

Error-Amplifier Compensation Design

The loop-compensation values are calculated as:

$$R_Z = 450 \times \sqrt{\frac{1 + \left(\frac{0.1f_{SW}}{f_P}\right)^2}{2 \times L_{PRI} \times f_{SW}}} \times V_{OUTF} \times I_{OUTF}$$

$$f_P = \frac{I_{OUTF}}{\pi \times V_{OUTF} \times C_{OUTF}}$$

$$C_Z = \frac{1}{\pi \times R_Z \times f_P}$$

$$C_P = \frac{1}{\pi \times R_Z \times f_{SW}}$$

The devices' switching frequency (f_{SW}) can be obtained from the [Electrical Characteristics](#) section.

In a typical application, the integrated step-down regulator is fed off the flyback converter's output. The step-down regulator poses negative input impedance or constant input power behavior. Due to this behavior, the loop bandwidth measured for the flyback converter would be smaller than the design bandwidth.

CCM Flyback

Transformer Turns Ratio Calculation ($K = N_s/N_p$)

The transformer turns ratio can be calculated using the following equation:

$$K = \frac{(V_{OUT} + V_D) \times (1 - D_{MAX})}{V_{INMIN} \times D_{MAX}}$$

where D_{MAX} is the duty cycle assumed at minimum input (0.35 for the MAX17497A and 0.7 for the MAX17497B).

Primary Inductance Calculation

Calculate the primary inductance based on the ripple:

$$L_{PRI} = \frac{(V_{OUTF} + V_D) \times (1 - D_{NOM}) \times K}{2 \times I_{OUTF} \times \beta \times f_{SW}}$$

where D_{NOM} , the nominal duty cycle at nominal operating DC input voltage (V_{INNOM}), is given as:

$$D_{NOM} = \frac{(V_{OUT} + V_D) \times K}{[V_{INNOM} + (V_{OUT} + V_D) \times K]}$$

The output current, down to which the flyback converter should operate in CCM, is determined by selection of the fraction β in the above primary inductance formula. For example, β should be selected as 0.15 so that the converter operates in CCM down to 15% of the maximum output-load current. Since the ripple in the primary current waveform is a function of duty cycle, and is maximum-at-maximum DC input voltage, the maximum (worst-case) load current, down to which the converter operates in CCM, occurs at maximum operating DC input voltage. V_D is the forward drop of the selected output diode at maximum output current.

Peak and RMS Current Calculation

RMS current values in the primary and secondary are needed by the transformer manufacturer to design the wire diameter for the different windings. Peak-current calculations are useful in setting the current limit. Use the following equations to calculate the primary and secondary peak and RMS currents:

Maximum primary peak current:

$$I_{PRIPEAK} = \left(\frac{I_{OUTF} \times K}{1 - D_{MAX}}\right) + \left(\frac{V_{INMIN} \times D_{MAX}}{2 \times L_{PRI} \times f_{SW}}\right)$$

Maximum primary RMS current:

$$I_{PRI RMS} = \sqrt{\frac{I_{PRIPEAK}^2 + \Delta I_{PRI}^2 - (I_{PRIPEAK} \times \Delta I_{PRI})}{3}} \times \sqrt{D_{MAX}}$$

where ΔI_{PRI} is the ripple current in the primary current waveform, and is given by:

$$\Delta I_{PRI} = \left(\frac{V_{INMIN} \times D_{MAX}}{L_{PRI} \times f_{SW}}\right)$$

Maximum secondary peak current:

$$I_{SECPEAK} = \frac{I_{PRIPEAK}}{K}$$

Maximum secondary RMS current:

AC-DC and DC-DC Peak-Current-Mode Converters with Integrated Step-Down Regulator

$$I_{\text{SECRMS}} = \sqrt{\frac{I_{\text{SECPEAK}}^2 + \Delta I_{\text{SEC}}^2 + (I_{\text{SECPEAK}} \times \Delta I_{\text{SEC}})}{3} \times \sqrt{1 - D_{\text{MAX}}}}$$

where ΔI_{SEC} is the ripple current in the secondary current waveform, and is given by:

$$\Delta I_{\text{SEC}} = \left(\frac{V_{\text{INMIN}} \times D_{\text{MAX}}}{L_{\text{PRI}} \times f_{\text{SW}} \times K} \right)$$

Current-limit setting the peak current can be calculated as follows:

$$I_{\text{LIMF}} = I_{\text{PRIPEAK}} \times 1.2$$

Primary RCD Snubber Selection

The design procedure for RCD snubber selection is identical to that outlined in the *DCM Flyback* section.

Output-Capacitor Selection

X7R ceramic output capacitors are preferred in industrial applications due to their stability over temperature. The output capacitor is usually sized to support a step load of 50% of the maximum output current in the application, such that the output-voltage deviation is contained to 3% of the output-voltage change. The output capacitance can be calculated as:

$$C_{\text{OUTF}} = \frac{I_{\text{STEP}} \times t_{\text{RESPONSE}}}{\Delta V_{\text{OUTF}}}$$

$$t_{\text{RESPONSE}} \cong \left(\frac{0.33}{f_{\text{C}}} + \frac{1}{f_{\text{SW}}} \right)$$

where I_{STEP} is the load step, t_{RESPONSE} is the response time of the controller, ΔV_{OUTF} is the allowable output voltage deviation, and f_{C} is the target closed-loop crossover frequency. f_{C} is chosen to be less than 1/5 of the worst-case (lowest) RHP zero frequency (f_{ZRHP}). The right half-plane zero frequency is calculated as:

$$f_{\text{ZRHP}} = \frac{(1 - D_{\text{MAX}})^2 \times V_{\text{OUTF}}}{2 \times \pi \times D_{\text{MAX}} \times L_{\text{PRI}} \times I_{\text{OUTF}} \times K^2}$$

For the CCM flyback converter, the output capacitor supplies the load current when the main switch is on, and therefore the output-voltage ripple is a function of load current and duty cycle. Use the following equation to estimate the output-voltage ripple:

$$\Delta V_{\text{COUTF}} = \frac{I_{\text{OUTF}} \times D_{\text{MAX}}}{f_{\text{SW}} \times C_{\text{OUTF}}}$$

Input-Capacitor Selection

The design procedure for input capacitor selection is identical to that outlined in the *DCM Flyback* section.

External MOSFET Selection

The design procedure for external MOSFET selection is identical to that outlined in the *DCM Flyback* section.

Secondary Diode Selection

The design procedure for secondary diode selection is identical to that outlined in the *DCM Flyback* section.

Error-Amplifier Compensation Design

In the CCM flyback converter, the primary inductance and the equivalent load resistance introduces a right half-plane zero at the following frequency:

$$f_{\text{ZRHP}} = \frac{(1 - D_{\text{MAX}})^2 \times V_{\text{OUTF}}}{2 \times \pi \times D_{\text{MAX}} \times L_{\text{PRI}} \times I_{\text{OUTF}} \times K^2}$$

The loop-compensation values are calculated as:

$$R_{\text{Z}} = \frac{225 \times I_{\text{OUTF}}}{(1 - D_{\text{MAX}})} \times \sqrt{1 + \left[\frac{f_{\text{ZRHP}}}{5 \times f_{\text{P}}} \right]^2}$$

where f_{P} , the pole due to output capacitor and load, is given by:

$$f_{\text{P}} = \frac{(1 + D_{\text{MAX}}) \times I_{\text{OUTF}}}{2 \times \pi \times C_{\text{OUTF}} \times V_{\text{OUTF}}}$$

The above selection sets the loop-gain crossover frequency (f_{C} , where the loop gain equals 1) equal to 1/5 the right half-plane zero frequency:

$$f_{\text{C}} \leq \frac{f_{\text{ZRHP}}}{5}$$

With the control-loop zero placed at the load pole frequency:

$$C_{\text{Z}} = \frac{1}{2\pi \times R_{\text{Z}} \times f_{\text{P}}}$$

With the high-frequency pole placed at 1/2 the switching frequency:

$$C_{\text{P}} = \frac{1}{\pi \times R_{\text{Z}} \times f_{\text{SW}}}$$

AC-DC and DC-DC Peak-Current-Mode Converters with Integrated Step-Down Regulator

DCM Boost

In a DCM boost converter, the inductor current returns to zero in every switching cycle. Energy stored during the on-time of the main switch is delivered entirely to the load in each switching cycle.

Inductance Selection

The design procedure starts with calculating the boost converter's input inductor, such that it operates in DCM at all operating line and load conditions. The critical inductance required to maintain DCM operation is calculated as:

$$L_{IN} \leq \frac{[(V_{OUTF} - V_{INMIN}) \times V_{INMIN}^2] \times 0.4}{I_{OUTF} \times V_{OUTF}^2 \times f_{SW}}$$

where V_{INMIN} is the minimum input voltage.

Peak/RMS Current Calculation

To set the current limit, the peak current in the inductor can be calculated as:

$$I_{LIMF} = I_{PK} \times 1.2$$

where I_{PK} is given by:

$$I_{PK} = \sqrt{\frac{2 \times (V_{OUTF} - V_{INMIN}) \times I_{OUTF}}{L_{INMIN} \times f_{SWMIN}}}$$

L_{INMIN} is the minimum value of the input inductor, taking into account tolerance and saturation effects. f_{SWMIN} is the minimum switching frequency for the MAX17497B from the [Electrical Characteristics](#) section.

Output-Capacitor Selection

X7R ceramic output capacitors are preferred in industrial applications due to their stability over temperature. The output capacitor is usually sized to support a step load of 50% of the maximum output current in the application, such that the output-voltage deviation is contained to 3% of the output-voltage change. The output capacitance can be calculated as:

$$C_{OUT} = \frac{I_{STEP} \times t_{RESPONSE}}{\Delta V_{OUTF}}$$

$$t_{RESPONSE} \cong \left(\frac{0.33}{f_C} + \frac{1}{f_{SW}} \right)$$

where I_{STEP} is the load step, $t_{RESPONSE}$ is the response time of the controller, ΔV_{OUTF} is the allowable output-voltage deviation, and f_C is the target closed-loop cross-over frequency. f_C is chosen to be 1/10 the switching frequency (f_{SW}). For the boost converter, the output capacitor supplies the load current when the main switch is on, and therefore the output-voltage ripple is a function of duty cycle and load current. Use the following equation to calculate the output-capacitor ripple:

$$\Delta V_{COUTF} = \frac{I_{OUTF} \times L_{IN} \times I_{PK}}{V_{INMIN} \times C_{OUTF}}$$

Input-Capacitor Selection

The value of the required input capacitor can be calculated based on the ripple allowed on the input DC bus. The size of the input capacitor should be based on the RMS value of the AC current handled by it. The calculations are as:

$$C_{INF} = \left[\frac{3.75 \times I_{OUTF}}{V_{INMIN} \times f_{SWMIN} \times (1 - D_{MAX})} \right]$$

The capacitor RMS can be calculated as:

$$I_{CIN_RMS} = \frac{I_{PK}}{2 \times \sqrt{3}}$$

Error-Amplifier Compensation Design

The loop-compensation values for the error amplifier can now be calculated as:

$$C_Z = \frac{G_{DC} \times G_M \times 10}{2 \times \pi \times f_{SW}} = (G_{DC} \times 10) \text{ nF}$$

where G_{DC} , the DC gain of the power stage is given as:

$$G_{DC} = \sqrt{\frac{8 \times (V_{OUTF} - V_{INMIN}) \times f_{SW} \times V_{OUTF}^2 \times L_{IN}}{(2V_{OUTF} - V_{INMIN})^2 \times I_{OUTF}}}$$

$$R_Z = \frac{V_{OUTF} \times C_{OUTF} \times (V_{OUTF} - V_{INMIN})}{I_{OUTF} \times C_Z \times (2V_{OUTF} - V_{INMIN})}$$

where V_{INMIN} is the minimum operating input voltage and I_{OUTF} is the maximum load current:

$$C_P = \frac{C_{OUTF} \times ESR}{R_Z}$$

AC-DC and DC-DC Peak-Current-Mode Converters with Integrated Step-Down Regulator

Slope Compensation

In theory, the DCM boost converter does not require slope compensation for stable operation. In practice, the converter needs a minimum amount of slope for good noise immunity at very light loads. The minimum slope is set for the devices by connecting the SCOMPF pin to the VCC pin.

Output Diode Selection

The voltage rating of the output diode for the boost converter ideally equals the output voltage of the boost converter. In practice, parasitic inductances and capacitances in the circuit interact to produce voltage overshoot during the turn-off transition of the diode that occurs when the main switch turns on. The diode rating should therefore be selected with the necessary margin to accommodate this extra voltage stress. A voltage rating of $1.3 \times V_{OUTF}$ provides the necessary design margin in most cases.

The current rating of the output diode should be selected such that the power loss in the diode (given as the product of forward-voltage drop and the average diode current) should be low enough to ensure that the junction temperature is within limits. This necessitates the diode current rating to be in the order of $2 \times I_{OUTF}$ to $3 \times I_{OUTF}$. Select fast-recovery diodes with a recovery time less than 50ns, or Schottky diodes with low junction capacitance.

Internal MOSFET RMS Current Calculation

The voltage stress on the internal MOSFET, whose drain is connected to LXF, ideally equals the sum of the output voltage and the forward drop of the output diode. In practice, voltage overshoot and ringing occur due to action of circuit parasitic elements during the turn-off transition. The maximum rating of the internal nMOSFET of the devices is 65V, making it possible to design boost converters with output voltages up to 48V, with sufficient margin for voltage overshoot and ringing. The RMS current into LXF is useful in estimating the conduction loss in the internal nMOSFET and is given as:

$$I_{LXF_RMS} = \sqrt{\frac{I_{PK}^3 \times L_{INS} \times f_{SW}}{3 \times V_{INMIN}}}$$

where I_{PK} is the peak current calculated at the lowest operating input voltage (V_{INMIN}).

CCM Boost

In a CCM boost converter, the inductor current does not return to zero during a switching cycle. Since the MAX17497B implements a nonsynchronous boost converter, the inductor current enters DCM operation at load currents below a critical value, equal to 1/2 the peak-to-peak ripple in the inductor current.

Inductor Selection

The design procedure starts with calculating the boost converter's input inductor at nominal input voltage for a ripple in the inductor current, equal to 30% of the maximum input current:

$$L_{IN} = \frac{V_{IN} \times D \times (1-D)}{0.3 \times I_{OUTF} \times f_{SW}}$$

where D is the duty cycle calculated as:

$$D = \frac{V_{OUTF} + V_D - V_{IN}}{V_{OUTF} + V_D - (R_{DS} \times I_{OUTF})}$$

V_D is the voltage drop across the output diode of the boost converter at maximum output current, and R_{DS} is the resistance of the internal nMOSFET at LXF in the on state.

Peak/RMS Current Calculation

To set the current limit, the peak current in the inductor and internal nMOSFET can be calculated as:

$$I_{PK} = \left[\frac{V_{OUTF} \times D_{MAX} \times (1-D_{MAX})}{L_{INMIN} \times f_{SWMIN}} + \frac{I_{OUTF}}{(1-D)} \right] \times 1.2$$

for $D_{MAX} < 0.5$

$$I_{PK} = \left[\frac{0.25 \times V_{OUTF}}{L_{INMIN} \times f_{SWMIN}} + \frac{I_{OUTF}}{(1-D)} \right] \times 1.2 \text{ for } D_{MAX} \geq 0.5$$

D_{MAX} , the maximum duty cycle, is obtained by substituting the minimum input operating voltage (V_{INMIN}) in the equation above for duty cycle. L_{INMIN} is the minimum value of the input inductor taking into account tolerance and saturation effects. f_{SWMIN} is the minimum switching frequency for the MAX17497B from the [Electrical Characteristics](#) section.

AC-DC and DC-DC Peak-Current-Mode Converters with Integrated Step-Down Regulator

Output-Capacitor Selection

X7R ceramic output capacitors are preferred in industrial applications due to their stability over temperature. The output capacitor is usually sized to support a step load of 50% of the maximum output current in the application, such that the output-voltage deviation is contained to 3% of the output-voltage change. The output capacitance can be calculated as:

$$C_{\text{OUTF}} = \frac{I_{\text{STEP}} \times t_{\text{RESPONSE}}}{\Delta V_{\text{OUTF}}}$$

$$t_{\text{RESPONSE}} \cong \left(\frac{0.33}{f_C} + \frac{1}{f_{\text{SW}}} \right)$$

where I_{STEP} is the load step, t_{RESPONSE} is the response time of the controller, ΔV_{OUTF} is the allowable output-voltage deviation, and f_C is the target closed-loop crossover frequency. f_C is chosen as 1/10 the switching frequency (f_{SW}). For the boost converter, the output capacitor supplies the load current when the main switch is on, and therefore the output-voltage ripple is a function of duty cycle and load current. Use the following equation to calculate the output-capacitor ripple:

$$\Delta V_{\text{COUTF}} = \frac{I_{\text{OUTF}} \times D_{\text{MAX}}}{C_{\text{OUTF}} \times f_{\text{SW}}}$$

Input-Capacitor Selection

The input ceramic capacitor value required can be calculated based on the ripple allowed on the input DC bus. The input capacitor should be sized based on the RMS value of the AC current handled by it. The calculations are as:

$$C_{\text{INF}} = \left[\frac{3.75 \times I_{\text{OUTF}}}{V_{\text{INMIN}} \times f_{\text{SW}} \times (1 - D_{\text{MAX}})} \right]$$

The input-capacitor RMS current can be calculated as:

$$I_{\text{CIN_RMS}} = \frac{\Delta I_{\text{LIN}}}{2 \times \sqrt{3}}$$

where:

$$\Delta I_{\text{LIN}} = \left[\frac{V_{\text{OUTF}} \times D_{\text{MAX}} \times (1 - D_{\text{MAX}})}{L_{\text{INMIN}} \times f_{\text{SWMIN}}} \right] \text{ for } D_{\text{MAX}} < 0.5$$

$$\Delta I_{\text{LIN}} = \left[\frac{0.25 \times V_{\text{OUTF}}}{L_{\text{INMIN}} \times f_{\text{SWMIN}}} \right] \text{ for } D_{\text{MAX}} \geq 0.5$$

Error-Amplifier Compensation Design

The loop-compensation values for the error amplifier can now be calculated as:

$$R_Z = \frac{250 \times V_{\text{OUTF}}^2 \times C_{\text{OUTF}} \times (1 - D_{\text{MIN}})}{I_{\text{OUTF_MIN}} \times L_{\text{IN}}}$$

where D_{MIN} is the duty cycle at the highest operating input voltage and $I_{\text{OUTF_MIN}}$ is the minimum load current:

$$C_Z = \frac{V_{\text{OUTF}} \times C_{\text{OUTF}}}{2 \times I_{\text{OUTF}} \times R_Z}$$

$$C_P = \frac{1}{\pi \times f_{\text{SW}} \times R_Z}$$

Slope-Compensation Ramp

The slope required to stabilize the converter at duty cycles greater than 50% can be calculated as:

$$S_E = \frac{0.5 \times (0.82 \times V_{\text{OUTF}} - V_{\text{INMIN}})}{L_{\text{IN}}} \text{ V per } \mu\text{s}$$

where L_{IN} is in μH .

Output Diode Selection

The design procedure for output diode selection is identical to that outlined in the *DCM Boost* section.

Internal MOSFET RMS Current Calculation

The voltage stress on the internal MOSFET, whose drain is connected to LXF, ideally equals the sum of the output voltage and the forward drop of the output diode. In practice, voltage overshoot and ringing occur due to action of circuit parasitic elements during the turn-off transition. The devices' maximum rating of the internal nMOSFET is 65V, making it possible to design boost converters with output voltages up to 48V, with sufficient margin for voltage overshoot and ringing. The RMS current into LXF is useful in estimating the conduction loss in the internal nMOSFET and is given as:

$$I_{\text{LXF_RMS}} = \frac{I_{\text{OUTF}} \times \sqrt{D_{\text{MAX}}}}{(1 - D_{\text{MAX}})}$$

where D_{MAX} is the duty cycle at the lowest operating input voltage and I_{OUTF} is the maximum load current.

AC-DC and DC-DC Peak-Current-Mode Converters with Integrated Step-Down Regulator

Thermal Considerations

It should be ensured that the junction temperature of the devices does not exceed +125°C under the operating conditions specified for the power supply. The power dissipated in the devices to operate can be calculated using the following equation:

$$P_{IN} = V_{IN} \times I_{IN}$$

where V_{IN} is the voltage applied at the IN pin and I_{IN} is operating supply current.

The internal nMOSFET experiences conduction loss and transition loss when switching between on and off states. These losses are calculated as:

$$P_{CONDUCTION} = I_{LXF_RMS}^2 \times R_{DSON_LXF}$$

$$P_{TRANSITION} = 0.5 \times V_{INMAX} \times I_{PK} \times (t_R + t_F) \times f_{SW}$$

where t_R and t_F are the rise and fall times of the internal nMOSFET in CCM operation. In DCM operation, because the switch current starts from zero only, t_F exists and the transition loss equation changes to:

$$P_{TRANSITION} = 0.5 \times V_{INMAX} \times I_{PK} \times t_F \times f_{SW}$$

Additional loss occurs in the system in every switching cycle due to energy stored in the drain-source capacitance of the internal MOSFET being lost when the MOSFET turns on and discharges the drain-source capacitance voltage to zero. This loss is estimated as:

$$P_{CAP} = 0.5 \times C_{DS} \times V_{DSMAX}^2 \times f_{SW}$$

The internal step-down regulator also has similar losses that affect the temperature rise of the part. These losses are estimated as:

$$P_{LOSSBUCK} = P_{OUT} \times \left(\frac{1}{\eta} - 1\right) - (I_{OUTB}^2 \times R_{DC})$$

where η is the efficiency of the internal step-down regulator at the output current (I_{OUTB}), and R_{DC} is the DC resistance of the output inductor.

The total power loss in the devices can be calculated from the following equation:

$$P_{LOSS} = P_{IN} + P_{CONDUCTION} + P_{TRANSITION} + P_{CAP} + P_{LOSSBUCK}$$

The maximum power that can be dissipated in the devices is 1666mW at +70°C temperature. The power-dissipation capability should be derated as the temperature rises above +70°C at 21mW/°C. For a multilayer board, the thermal-performance metrics for the package are given below:

$$\theta_{JA} = 48^\circ\text{C/W}$$

$$\theta_{JC} = 10^\circ\text{C/W}$$

The junction temperature rise of the devices can be estimated at any given maximum ambient temperature (T_{A_MAX}) from the following equation:

$$T_{J_MAX} = T_{A_MAX} + (\theta_{JA} \times P_{LOSS})$$

If the application has a thermal-management system that ensures that the devices' exposed pad is maintained at a given temperature (T_{EP_MAX}) by using proper heatsinks, then the junction temperature rise can be estimated at any given maximum ambient temperature from the following equation:

$$T_{J_MAX} = T_{EP_MAX} + (\theta_{JC} \times P_{LOSS})$$

MAX17497A/MAX17497B

AC-DC and DC-DC Peak-Current-Mode Converters with Integrated Step-Down Regulator

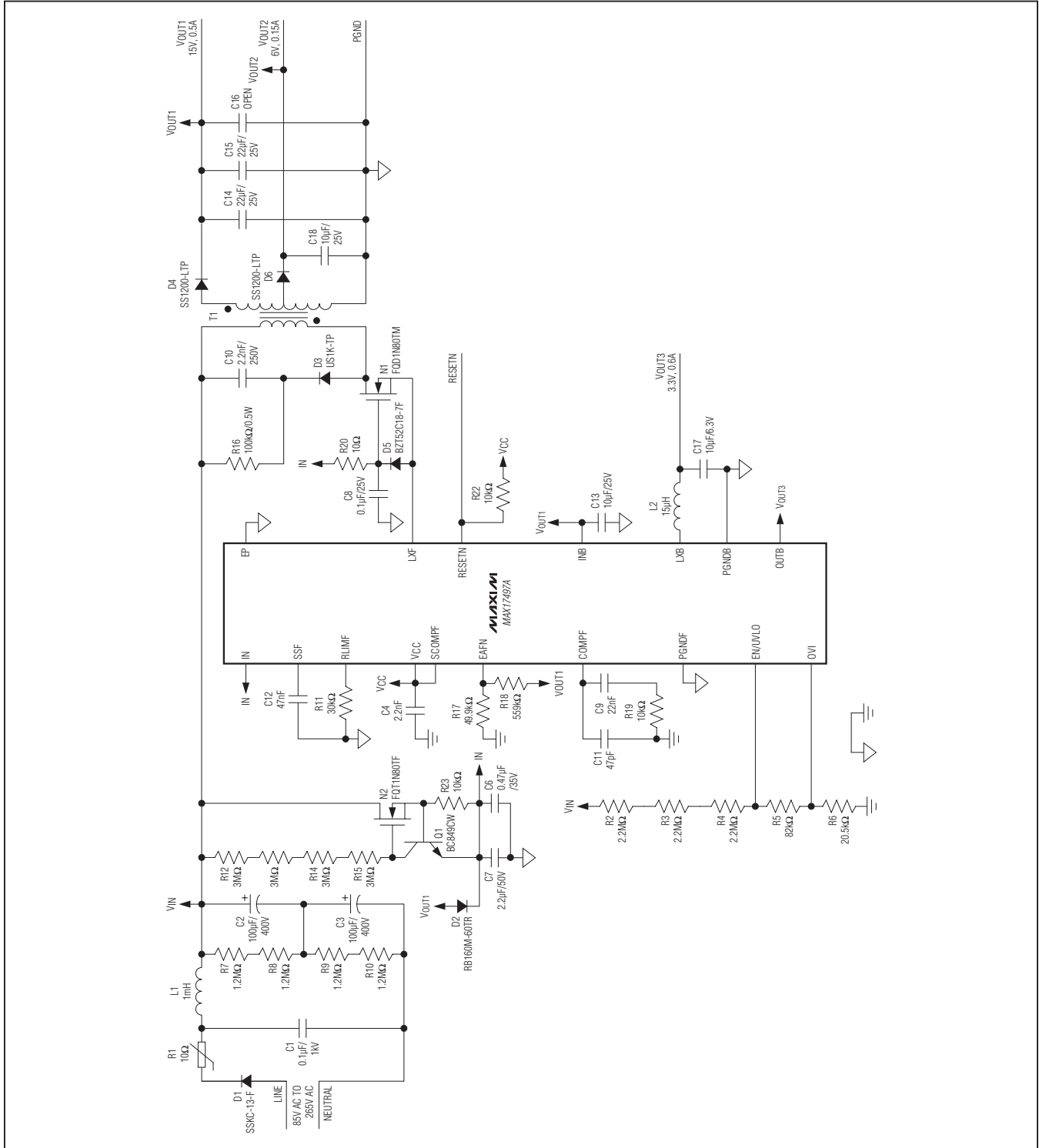

Figure 10. MAX17497A Typical Application Example (e.g., Smart Meter)

MAX17497A/MAX17497B

AC-DC and DC-DC Peak-Current-Mode Converters with Integrated Step-Down Regulator

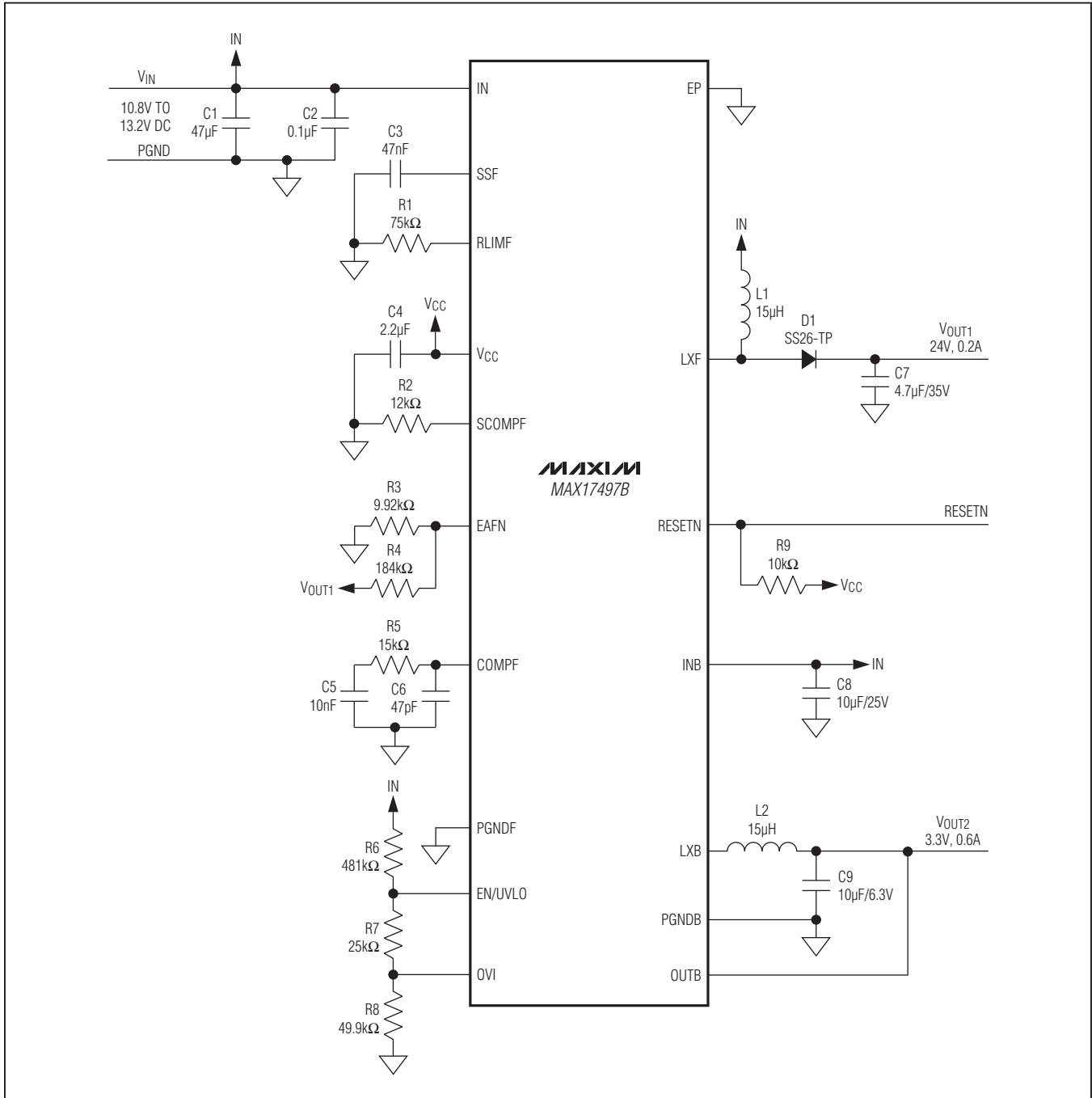

Figure 11. MAX17497B Typical Application Example

MAX17497A/MAX17497B

AC-DC and DC-DC Peak-Current-Mode Converters with Integrated Step-Down Regulator

Layout, Grounding, and Bypassing

All connections carrying pulsed currents must be very short and as wide as possible. The inductance of these connections must be kept to an absolute minimum due to the high di/dt of the currents in high-frequency switching power converters. This implies that the loop areas for forward and return pulsed currents in various parts of the circuit should be minimized. Additionally, small-current loop areas reduce radiated EMI. Similarly, the heatsink of the main MOSFET presents a dV/dt source; therefore, the surface area of the MOSFET heatsink should be minimized as much as possible.

Ground planes must be kept as intact as possible. The ground plane for the power section of the converter should be kept separate from the analog ground plane,

except for a connection at the least noisy section of the power ground plane, typically the return of the input filter capacitor. The negative terminal of the filter capacitor, the ground return of the power switch, and the current-sensing resistor must be close together. PCB layout also affects the thermal performance of the design. A number of thermal vias that connect to a large ground plane should be provided under the exposed pad of the part for efficient heat dissipation. For a sample layout that ensures first-pass success, refer to the MAX17497A evaluation kit layout available at www.maxim-ic.com.

For universal AC input designs, follow all applicable safety regulations. Offline power supplies can require UL, VDE, and other similar agency approvals.

Ordering Information

PART	TEMP RANGE	PIN-PACKAGE	DESCRIPTION
MAX17497AATE+	-40°C to +125°C	16 TQFN	250kHz, Offline Flyback/Forward Converter with 3.3V, 600mA Synchronous Step-Down Converter
MAX17497BATE+*	-40°C to +125°C	16 TQFN	500kHz, Flyback/Boost Converter with 3.3V, 600mA Synchronous Step-Down Converter

+Denotes a lead(Pb)-free/RoHS-compliant package.

*Future product—contact factory for availability.

Package Information

For the latest package outline information and land patterns (footprints), go to www.maxim-ic.com/packages. Note that a "+", "#", or "-" in the package code indicates RoHS status only. Package drawings may show a different suffix character, but the drawing pertains to the package regardless of RoHS status.

PACKAGE TYPE	PACKAGE CODE	OUTLINE NO.	LAND PATTERN NO.
16 TQFN	T1633+5	21-0136	90-0032

MAX17497A/MAX17497B

AC-DC and DC-DC Peak-Current-Mode Converters with Integrated Step-Down Regulator

Revision History

REVISION NUMBER	REVISION DATE	DESCRIPTION	PAGES CHANGED
0	11/11	Initial release	—

Maxim cannot assume responsibility for use of any circuitry other than circuitry entirely embodied in a Maxim product. No circuit patent licenses are implied. Maxim reserves the right to change the circuitry and specifications without notice at any time. The parametric values (min and max limits) shown in the Electrical Characteristics table are guaranteed. Other parametric values quoted in this data sheet are provided for guidance.

Maxim Integrated Products, 120 San Gabriel Drive, Sunnyvale, CA 94086 408-737-7600 _____ 30