

PLEASE CHECK WWW.MOLEX.COM FOR LATEST PART INFORMATION

Part Number: [5024391400](#)
Status: **Active**
Description: 2.00mm (.079") Pitch CLIK-Mate™ Wire-to-Board Housing, Single Row, Positive Lock, 14 Circuits

Documents:

[3D Model](#) [Product Specification PS-502443-001 \(PDF\)](#)
[Drawing \(PDF\)](#) [Related Catalog Page \(PDF\)](#)

General

Product Family Crimp Housings
 Series [502439](#)
 Product Name CLIK-Mate™

Physical

Breakaway No
 Circuits (maximum) 14
 Color - Resin White
 Gender Plug
 Keying to Mating Part Yes
 Lock to Mating Part Yes
 Number of Rows 1
 Packaging Type Bag
 Panel Mount No
 Pitch - Mating Interface (in) 0.079 In
 Pitch - Mating Interface (mm) 2.00 mm
 Polarized to Mating Part Yes
 Stackable No
 Temperature Range - Operating -25°C to +85°C

Material Info

Reference - Drawing Numbers

Product Specification PS-502443-001
 Sales Drawing SD-502439-002

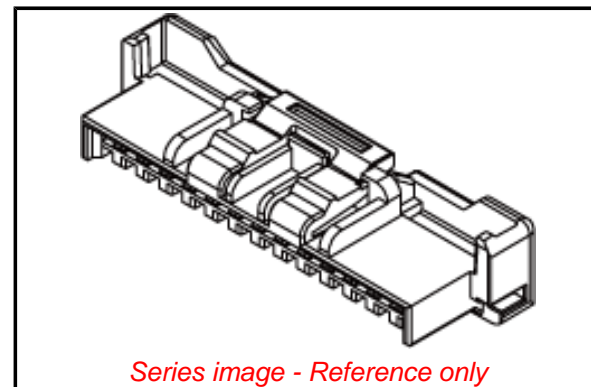

EU RoHS

**ELV and RoHS
Compliant**

China RoHS



**Need more information on product
environmental compliance?**

Email productcompliance@molex.com
 Please visit the [Contact Us](#) section for any
 non-product compliance questions.

Search Parts in this Series

[502439](#) Series

Mates With

[502443](#) PCB Receptacle Vertical . [502494](#)
 PCB Receptacle Right Angle

Use With

[502438](#) Crimp Terminal



PRODUCT SPECIFICATION



LANGUAGE
JAPANESE
ENGLISH

【 1. 適用範囲 SCOPE 】

本仕様書は、_____ 殿 に納入する
_____ 2.0mm ピッチ 電線対基板 コネクタ (1列品) _____ について規定する。
This specification covers the 2.0 mm PITCH WIRE TO BOARD CONNECTOR (SINGLE TYPE) series

【 2. 製品名称及び型番 PRODUCT NAME AND PART NUMBER 】

製品名称 Product Name	製品型番 Part Number
プラグ ターミナル Plug Terminal	5 0 2 4 3 8 - 0 * 0 0
プラグハウジング (ポジティブロック付き) Plug Housing (With Positive Lock)	5 0 2 4 3 9 - * * 0 0
ストレートリセアセンブリ Straight Receptacle Assembly	5 0 2 4 4 3 - * * 0 9
5 0 2 4 4 3 エンボス梱包品 Embossed Tape Packaging For 502443-**09	5 0 2 4 4 3 - * * 7 0
ライトアングルリセアセンブリ Right Angle Receptacle Assembly	5 0 2 4 9 4 - * * 0 9
5 0 2 4 9 4 エンボス梱包品 Embossed Tape Packaging For 502494-**09	5 0 2 4 9 4 - * * 7 0

* : 図面参照 Refer to the drawing.

【 3. 定格及び適用電線 RATINGS AND APPLICABLE WIRES 】

項目 Item	規格 Standard	
最大許容電圧 Rated Voltage (MAX.)	250 V	
最大許容電流及び適用電線 Rated Current (MAX.) and Applicable wires	AWG#22	3.0A
	AWG#24	2.0A
	AWG#26	1.5A
使用温度範囲 Ambient Temperature Range (Operating and Non-operating)	-25℃ ~ + 85℃ *1 低温において氷結しないこと Not freeze to low temperature	

*1 : 通電による温度上昇分も含む。 Including terminal temperature rise.

作成	E																				
SHEET	1~13																				
REVISE ON PC ONLY										TITLE: 2.0mm PITCH WIRE TO BOARD CONNECTOR SINGLE TYPE											
E	変更 REVISED J2008-2504 '07/12/21 Y.GOTO										製品仕様書										
	THIS DOCUMENT CONTAINS INFORMATION THAT IS PROPRIETARY TO MOLEX INC. AND SHOULD NOT BE USED WITHOUT WRITTEN PERMISSION																				
REV.	DESCRIPTION										WRITTEN BY:	CHECKED BY:	APPROVED BY:	DATE : YR/MO/DAY							
J	DESIGN CONTROL										Y.GOTO	K.ASAKAWA	YO.ITO	2007/03/20							
DOCUMENT NUMBER										FILE NAME										SHEET	
PS-502443-001										PS502443001.doc										1 OF 14	
EN-37(019)																					



【 4 . 性能 PERFORMANCE 】

4 - 1 .電氣的性能 Electrical performance

項 目 Item		条 件 Test Condition	規 格 Requirement
4-1-1	接 触 抵 抗 Contact Resistance	コネクタを嵌合させ、開放電圧 20mV以下、短絡電流 10mA にて測定する。 (JIS C5402 5.4) Mate connectors and measured by dry circuit, 20mV MAX., 10mA. (JIS C5402 5.4)	20 milliohms MAX.
4-1-2	絶 縁 抵 抗 Insulation Resistance	コネクタを嵌合させ、隣接するターミナル間及びターミナル、アース間に、DC 250Vを印加し測定する。 (JIS C5402 5.2/MIL-STD-202 試験法 302) Mate connectors and apply 250V DC between adjacent terminal or ground. (JIS C5402 5.2/MIL-STD-202 Method 302)	1000 Megohms MIN.
4-1-3	耐 電 圧 Dielectric Strength	コネクタを嵌合させ、隣接するターミナル間及びターミナル、アース間に、AC(rms) 800V (実効値) を1分間 印加する。感度電流 2mA (JIS C5402 5.1/MIL-STD-202 試験法 301) Mate connectors and apply 800V AC(rms) for 1 minute between adjacent terminal or ground. Trip current 2mA. (JIS C5402 5.1/MIL-STD-202 Method 301)	異状なきこと No Breakdown
4-1-4	圧着部接触抵抗 Contact Resistance on Crimped Portion	ターミナルに適合電線を圧着し、開放電圧20mV以下、短絡電流 10mA にて測定する。 Crimp the applicable wire to the terminal, measured by dry circuit, 20mV MAX., 10mA.	5 milliohms MAX.

REVISE ON PC ONLY		TITLE: 2.0mm PITCH WIRE TO BOARD CONNECTOR SINGLE TYPE
E	SEE SHEET 1	
REV.	DESCRIPTION	製品仕様書 THIS DOCUMENT CONTAINS INFORMATION THAT IS PROPRIETARY TO MOLEX INC. AND SHOULD NOT BE USED WITHOUT WRITTEN PERMISSION

DOCUMENT NUMBER PS-502443-001	FILE NAME PS502443001.doc	SHEET 2 OF 14
---	------------------------------	------------------



4 - 2. 機械的性能 Mechanical Performance

項目 Item		条件 Test Condition		規格 Requirement
4-2-1	挿入力及び抜去力 Insertion and Withdrawal Force	手挿抜にて挿入、抜去を行う。 Insert and withdraw connectors with hand.		第6項参照 Refer to paragraph 6
4-2-2	圧着部引張強度 Crimping Pull out Force	圧着されたターミナルを治具に 固定し、電線を軸方向に 毎分25±3mmの速さで引張る。 (JIS C5402 6.8) Fix the crimped terminal, apply axial pull out force on the wire at the speed rate of 25±3mm/minute. (JIS C5402 6.8)	AWG#22	39.2N{4.0kgf}MIN.
			AWG#24	29.4N{3.0kgf}MIN.
			AWG#26	19.6N{2.0kgf}MIN.
4-2-3	ターミナル挿入力 Terminal Insertion Force	圧着されたターミナルをハウジングに挿入する。 Insert the crimped terminal into the housing.		9.8N { 1.0kgf } MAX.
4-2-4	プラグターミナル 保持力 Plug Terminal Retention Force	プラグハウジングに装着されたプラグターミナルを 毎分 1~5mm/sec の速さで引張る。 Apply axial pull out force at the speed rate of 1~5mm/sec on the plug terminal assembled in the plug housing.		9.8N { 1.0kgf } MIN.
4-2-5	リセターミナル 保持力 Rec. Terminal Retention Force	リセハウジングに装着されたターミナルを 毎分 25±3mm の速さで軸方向に引張る。 Apply axial pull out force at the speed rate of 25±3mm/minute on the rec. terminal assembled in the rec. housing.		2.94N {0.3 kgf} MIN.
4-2-6	ハウジングロック強度 (ポジティブロック) Housing Lock Strength (Positive Lock)	ハウジングを嵌合し、軸方向に毎分25±3mmの 速さで引張る。 Mated connectors, and apply axial pull out force at the speed rate of 25±3mm/minute.		29.4N {3.0 kgf} MIN.

REVISE ON PC ONLY		TITLE:	
E	SEE SHEET 1	2.0mm PITCH WIRE TO BOARD CONNECTOR SINGLE TYPE	
		製品仕様書	
REV.	DESCRIPTION	THIS DOCUMENT CONTAINS INFORMATION THAT IS PROPRIETARY TO MOLEX INC. AND SHOULD NOT BE USED WITHOUT WRITTEN PERMISSION	
DOCUMENT NUMBER PS-502443-001		FILE NAME PS502443001.doc	SHEET 3 OF 14



PRODUCT SPECIFICATION



LANGUAGE

JAPANESE
ENGLISH

4-3. その他 Environmental Performance and Others

項目 Item		条件 Test Condition	規格 Requirement	
4-3-1	挿抜寿命 Repeated Insertion / Withdrawal	1分間 10回 以下の速さで、手挿抜にて挿入、抜去を30回 繰返す。 When mated up to 30 cycles repeatedly by the rate of 10 cycles per minute with hand.	接触抵抗 Contact Resistance	40 milliohms MAX.
4-3-2	温度上昇 Temperature Rise	全ての圧着端子を最小導体の電線で直列に接続し定格電圧/電流で熱平衡に達した時の温度上昇を熱電対で測定する。 (但し、抵抗負荷) All crimp-style terminal shall be connected in a direct series by minimum AWG. The temperature rise shall be measured by thermocouple when the terminal reaches terminal equilibrium under rated voltage / rated current. (However with resistive load)	温度上昇 Temperature Rise	30 °C MAX.
4-3-3	耐振動性 Vibration	DC 1mA 通電状態にて、嵌合軸を含む互いに垂直な3方向に 掃引割合10~55~10 Hz/分、全振幅 1.52mm の振動を各2時間 加える。 (MIL-STD-202 試験法 201) Mate connectors and subject to the following vibration conditions, for a period of 2 hours in each of 3 mutually perpendicular axes, passing DC 1mA during the test. Amplitude : 1.52mm P-P Frequency : 10~55~10 Hz in 1 minute. Duration : 2 hours in each X.Y.Z.axes. (MIL-STD-202 Method 201)	外観 Appearance	異常なきこと No Damage
			接触抵抗 Contact Resistance	40 milliohms MAX.
			瞬断 Discontinuity	1 microsecond MAX.
4-3-4	耐衝撃性 Mechanical Shock	DC 1mA 通電状態にて、嵌合軸を含む互いに垂直な 6方向 に 490m/s ² { 50G }、作用時間 11msの衝撃を 各3回 加える。 (JIS C0041/MIL-STD-202 試験法 213) Mate connectors and subject to the following shock conditions. 3 shocks shall be applied along 3 mutually perpendicular axes, passing DC 1 mA current during the test. (Total of 18 shocks) Test pulse : Half Sine Peak value : 490 m/s ² (50 G) Duration : 11 ms (JIS C0041/MIL-STD-202 Method 213)	外観 Appearance	異常なきこと No Damage
			接触抵抗 Contact Resistance	40 milliohms MAX.
			瞬断 Discontinuity	1 microsecond MAX.

REVISE ON PC ONLY		TITLE: 2.0mm PITCH WIRE TO BOARD CONNECTOR SINGLE TYPE
E	SEE SHEET 1	
REV.	DESCRIPTION	製品仕様書 THIS DOCUMENT CONTAINS INFORMATION THAT IS PROPRIETARY TO MOLEX INC. AND SHOULD NOT BE USED WITHOUT WRITTEN PERMISSION

DOCUMENT NUMBER PS-502443-001	FILE NAME PS502443001.doc	SHEET 4 OF 14
---	------------------------------	------------------



PRODUCT SPECIFICATION



LANGUAGE

JAPANESE
ENGLISH

項 目 Item		条 件 Test Condition	規 格 Requirement	
4-3-5	耐熱性 Heat Resistance	コネクタを嵌合させ、85±2℃ の雰囲気中に96時間放置後取り出し、1時間室温に放置する。 (JIS C60068-2-2/MIL-STD-202 試験法 108) Mate connectors and expose to 85±2℃ for 96 hours. Upon completion of the exposure period, the test specimens shall be conditioned at ambient room conditions for 1 hour , after which the specified measurements shall be performed. (JIS C60068-2-2/MIL-STD-202 Method 108)	外 観 Appearance	異常なきこと No Damage
			接 触 抵 抗 Contact Resistance	40 milliohms MAX
4-3-6	耐寒性 Cold Resistance	コネクタを嵌合させ、-25±3℃ の雰囲気中に96時間 放置後取り出し、1時間 室温に放置する。(JIS C60068-2-1) Mate connectors and expose to -25±3℃ for 96 hours. Upon completion of the exposure period, the test specimens shall be conditioned at ambient room conditions for 1 hour, after which the specified measurements shall be performed. (JIS C60068-2-1)	外 観 Appearance	異常なきこと No Damage
			接 触 抵 抗 Contact Resistance	40 milliohms MAX.
4-3-7	耐湿性 Humidity	コネクタを嵌合させ、40±2℃、相対湿度90~95% の雰囲気中に 96時間 放置後取り出し、1時間 室温に放置する。 (JIS C60068-2-3/MIL-STD-202 試験法 103) Mate connectors and expose to 40±2℃, relative humidity 90 to 95% for 96 hours. Upon completion of the exposure period, the test specimens shall be conditioned at ambient room conditions for 1 to 2 hours, after which the specified measurements shall be performed. (JIS C60068-2-3/MIL-STD-202 Method 103)	外 観 Appearance	異常なきこと No Damage
			接 触 抵 抗 Contact Resistance	40 milliohms MAX.
			絶 縁 抵 抗 Insulation Resistance	100 Megohm MIN.
			耐 電 圧 Dielectric Strength	4-1-3項満足のこと Must meet 4-1-3

REVISE ON PC ONLY		TITLE: 2.0mm PITCH WIRE TO BOARD CONNECTOR SINGLE TYPE
E	SEE SHEET 1	
REV.	DESCRIPTION	製品仕様書 THIS DOCUMENT CONTAINS INFORMATION THAT IS PROPRIETARY TO MOLEX INC. AND SHOULD NOT BE USED WITHOUT WRITTEN PERMISSION

DOCUMENT NUMBER PS-502443-001	FILE NAME PS502443001.doc	SHEET 5 OF 14
---	------------------------------	------------------



PRODUCT SPECIFICATION



LANGUAGE

JAPANESE
ENGLISH

項目 Item		条件 Test Condition	規格 Requirement	
4-3-8	温度サイクル Temperature Cycling	<p>コネクタを嵌合させ、$-25\pm 3^{\circ}\text{C}$ に 30分、$+85\pm 2^{\circ}\text{C}$ に 30分 これを1サイクルとし、5サイクル 繰返す。 但し、温度移行時間は 5分以内 とする。 試験後1~2時間 室温に放置する。 (JIS C0025)</p> <p>Mate connectors and subject to the following conditions for 5 cycles. Upon completion of the exposure period, the test specimens shall be conditioned at ambient room conditions for 1 to 2hours, after which the specified measurements shall be performed. 5 cycles of :</p> <p>a) $-25\pm 3^{\circ}\text{C}$ 30 minutes b) $+85\pm 2^{\circ}\text{C}$ 30 minutes (JIS C0025)</p>	外 観 Appearance	異常なきこと No Damage
			接 触 抵 抗 Contact Resistance	40 milliohms MAX.
4-3-9	塩 水 噴 霧 Salt Spray	<p>コネクタを嵌合させ、$35\pm 2^{\circ}\text{C}$ にて $5\pm 1\%$ 重量比の塩水を 48 ± 4時間噴霧し、試験後 常温で水洗いした後、室温で乾燥させる。 (JIS C60068-2-11/MIL-STD-202 試験法101)</p> <p>Mate connectors and expose to the following salt mist conditions. Upon completion of the exposure period, salt deposits shall be removed by a gentle wash or dip in running water, after which the specified measurements shall be performed. NaCl solution Concentration : $5\pm 1\%$ Spray time : 48 ± 4 hours Ambient temperature : $35\pm 2^{\circ}\text{C}$ (JIS 60068-2-11/MIL-STD-202 Method 101)</p>	外 観 Appearance	著しいサビの なきこと。 No Damage
			接 触 抵 抗 Contact Resistance	40 milliohms MAX.
4-3-10	耐亜硫酸ガス SO ₂ Gas	<p>コネクタを嵌合させ、$40\pm 2^{\circ}\text{C}$ にて $50\pm 5\text{ppm}$の亜硫酸ガス中に24時間放置する。 Mated connectors and expose to the conditions of $50\pm 5\text{ppm}$ SO₂ gas ambient temperature $40\pm 2^{\circ}\text{C}$ for 24 hours.</p>	外 観 Appearance	異常なきこと No Damage
			接 触 抵 抗 Contact Resistance	40 milliohms MAX.

REVISE ON PC ONLY

E

SEE SHEET 1

TITLE:

2.0mm PITCH WIRE TO BOARD CONNECTOR
SINGLE TYPE

製品仕様書

REV.

DESCRIPTION

THIS DOCUMENT CONTAINS INFORMATION THAT IS PROPRIETARY TO MOLEX INC. AND SHOULD NOT BE USED WITHOUT WRITTEN PERMISSION

DOCUMENT NUMBER

PS-502443-001

FILE NAME

PS502443001.doc

SHEET

6 OF 14



PRODUCT SPECIFICATION



LANGUAGE

JAPANESE
ENGLISH

項目 Item		条件 Test Condition	規格 Requirement	
4-3-11	耐アンモニア性 Ammonia gas	コネクタを嵌合させ、濃度28%のアンモニア水を入れた容器中に40分間放置する。 (1Lに対して25mLの割合) Mated connectors and expose to the conditions of NH3 gas evaporating from 28% Ammonia solution for 40 minutes.	外観 Appearance	割れ、ヒビ等の破損なきこと without damage such as cracks or other breaks
			接触抵抗 Contact Resistance	40 milliohms MAX.
4-3-12	半田付け性 Solderability	端子先端より 0.5mm の位置まで、 245±3℃の半田に4~5秒浸す。 Dip soldertails into the molten solder [held at 245±5 degree centigrade] up to 0.5mm from the bottom of the housing for 4~5 seconds.	濡れ性 Solder Wetting	浸漬面積の90%以上 90% of immersed area must show no voids, pin holes.
4-3-13	半田耐熱性 Resistance to Soldering Heat	リフロー時 第7項の条件にて実施する。 <u>Reflow soldering method</u> Reference reflow condition at 7 clause.	外観 Appearance	端子ガタ、割れ等 異状なきこと No Damage
		手半田時 端子先端及び金具先端より0.2mmの位置まで、350±10℃の半田ゴテにて3~4秒加熱する。 <u>Soldering iron method</u> 0.2mm from terminal tip Solder Temperature : 350±10℃ Soldering Time : 3~4 seconds MAX.		

() : 参考規格 Reference Standard
{ } : 参考単位 Reference Unit

REVISE ON PC ONLY		TITLE: 2.0mm PITCH WIRE TO BOARD CONNECTOR SINGLE TYPE	
E	SEE SHEET 1	製品仕様書	
REV.	DESCRIPTION	THIS DOCUMENT CONTAINS INFORMATION THAT IS PROPRIETARY TO MOLEX INC. AND SHOULD NOT BE USED WITHOUT WRITTEN PERMISSION	
DOCUMENT NUMBER PS-502443-001		FILE NAME PS502443001.doc	SHEET 7 OF 14



【 5. 外観形状、寸法及び材質 PRODUCT SHAPE, DIMENSIONS AND MATERIALS 】

1. 製品寸法 Dimensions of product

図面参照 Refer to the drawing.

2. リセハウジングの形状について About shape of rec housing

下図に示します溝形状は射出成形時のゲートの逃がしとして設定しております。
溝位置につきましては、金型レイアウトにより異なります。(右側、または左側)
Following features are designed for a gate offset when molding.
The slit position is different as molding die layout.

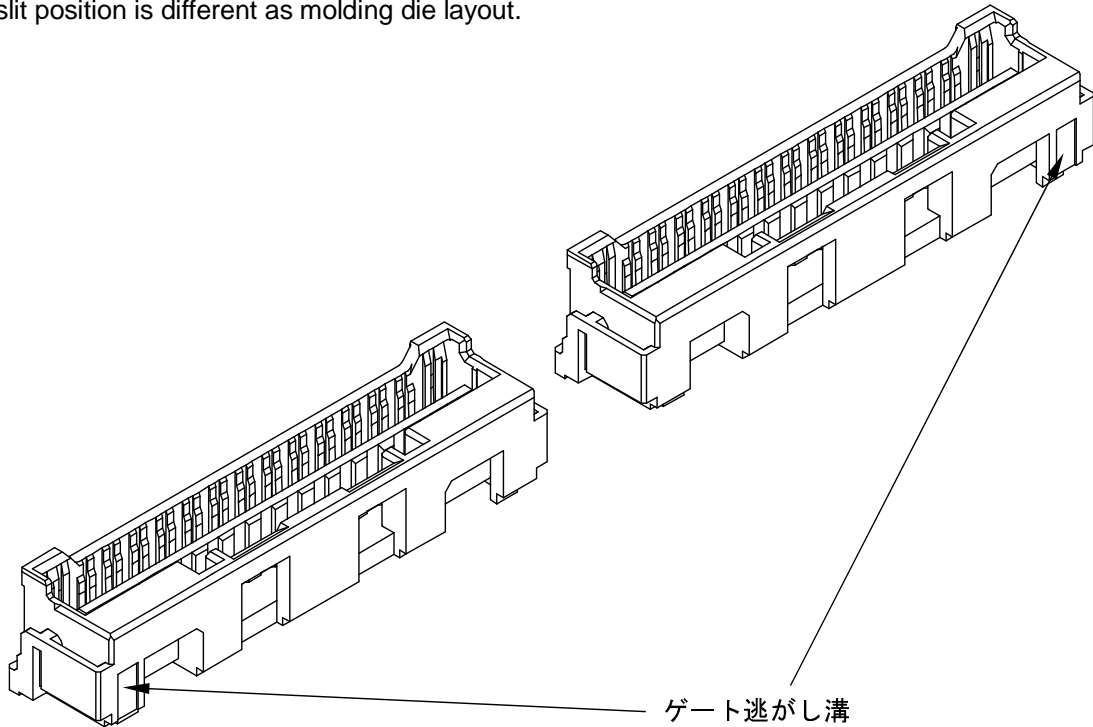

REVISE ON PC ONLY		TITLE: 2.0mm PITCH WIRE TO BOARD CONNECTOR SINGLE TYPE	製品仕様書
E	SEE SHEET 1		
REV.	DESCRIPTION	THIS DOCUMENT CONTAINS INFORMATION THAT IS PROPRIETARY TO MOLEX INC. AND SHOULD NOT BE USED WITHOUT WRITTEN PERMISSION	
DOCUMENT NUMBER PS-502443-001		FILE NAME PS502443001.doc	SHEET 8 OF 14



【 6. 挿入力及び抜去力 INSERTION / WITHDRAWAL FORCE 】

極数 No. of CKT	単位 UNIT	挿入力 (最大値) Insertion (MAX.)			抜去力 (最小値) Withdrawal (MIN.)		
		初回 1st	6回目 6th	30回目 30th	初回 1st	6回目 6th	30回目 30th
4	N {kgf}	12.9 { 1.32 }	14 { 1.43 }	18.3 { 1.87 }	0.8 { 0.08 }	0.8 { 0.08 }	0.8 { 0.08 }
5	N {kgf}	16.2 { 1.65 }	17.5 { 1.79 }	21.8 { 2.22 }	1.0 { 0.10 }	1.0 { 0.10 }	1.0 { 0.10 }
6	N {kgf}	19.4 { 1.98 }	21.5 { 2.20 }	24.8 { 2.53 }	1.2 { 0.12 }	1.2 { 0.12 }	1.2 { 0.12 }
8	N {kgf}	25.9 { 2.64 }	28 { 2.86 }	32.3 { 3.30 }	1.6 { 0.16 }	1.6 { 0.16 }	1.6 { 0.16 }
12	N {kgf}	38.8 { 3.96 }	42.5 { 4.33 }	46.3 { 4.72 }	2.4 { 0.24 }	2.4 { 0.24 }	2.4 { 0.24 }
13	N {kgf}	42 { 4.29 }	46.4 { 4.73 }	49.6 { 5.06 }	2.5 { 0.26 }	2.5 { 0.26 }	2.5 { 0.26 }
14	N {kgf}	45.3 { 4.62 }	49.6 { 5.06 }	52.8 { 5.39 }	2.7 { 0.28 }	2.7 { 0.28 }	2.7 { 0.28 }

※ロックを解除して測定 Released lock, and measure. { } :参考単位 Reference Unit

REVISE ON PC ONLY		TITLE: 2.0mm PITCH WIRE TO BOARD CONNECTOR SINGLE TYPE	
E	SEE SHEET 1	製品仕様書	
REV.	DESCRIPTION	THIS DOCUMENT CONTAINS INFORMATION THAT IS PROPRIETARY TO MOLEX INC. AND SHOULD NOT BE USED WITHOUT WRITTEN PERMISSION	
DOCUMENT NUMBER PS-502443-001		FILE NAME PS502443001.doc	SHEET 9 OF 14



【7. リフロー条件 REFLOW CONDITION】

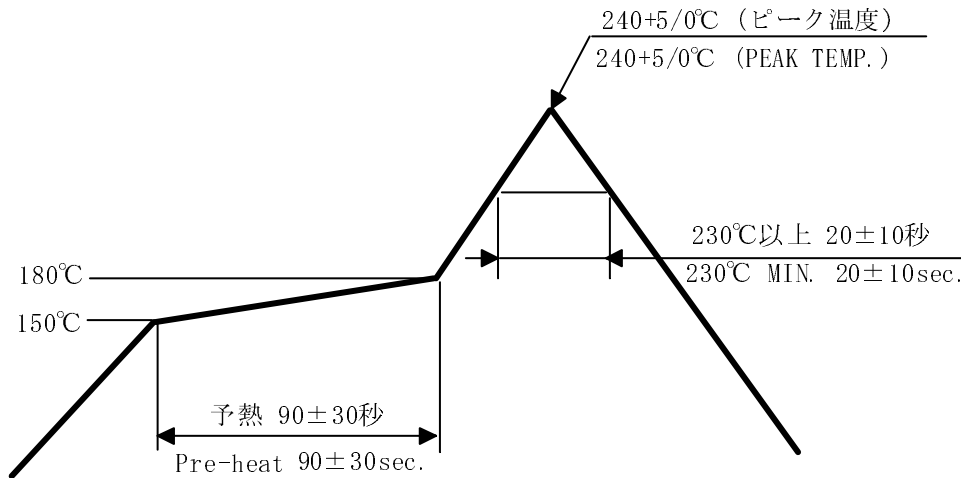

温度条件グラフ
 TEMPERATURE CONDITION GRAPH
 (半田接合部)
 (SOLDER JOINT PART)

注記：本リフロー条件に関しては、リフロー装置及び基板などにより条件が異なりますので
 事前に実装評価(リフロー評価)の御確認を御願ひ致します。
 端子テール部、ネイルが変色する場合がございますが、半田付け性には問題ありません。

NOTE : Please check the mount condition (reflow soldering condition) by your own devices
 beforehand, because the condition changes by the soldering devices, p.c. boards, and so on.
 Although tail of terminal and nail may discolors, a solderability does not have a problem

REVISE ON PC ONLY		TITLE: 2.0mm PITCH WIRE TO BOARD CONNECTOR SINGLE TYPE	
E	SEE SHEET 1	製品仕様書	
REV.	DESCRIPTION	THIS DOCUMENT CONTAINS INFORMATION THAT IS PROPRIETARY TO MOLEX INC. AND SHOULD NOT BE USED WITHOUT WRITTEN PERMISSION	
DOCUMENT NUMBER PS-502443-001		FILE NAME PS502443001.doc	SHEET 10 OF 14



【 8. 注記 NOTES 】

- 1. 本製品のプラスチック部に黒点等が確認される場合や色合いが異なる場合がありますが、製品性能に影響はありません。
There is no influence in the product performance though the black spot etc. might be confirmed to the plastic part of this product and the shade might be different.
- 2. 本製品は錫めっきを使用しているため、外観に摺動痕がつく場合が御座いますが、製品性能に影響はありません。
The wound of friction might adhere to externals because the tin plating is used for the tail and nail. But there is no influence in the product performance.
- 3. 本製品のハウジング及びメッキ表面に多少の傷が確認される場合がありますが、製品性能に問題ありません。
A few scratch may be confirmed to the surface of the housing and the plating of this product, however, There is no problem in the product performance.
- 4. 環境指令への適合 COMPLIANCE WITH ENVIRONMENTAL DIRECTIVE
ELV及びRoHS適合品
ELV and RoHS Compliant

E	REVISE ON PC ONLY	SEE SHEET 1	TITLE: 2.0mm PITCH WIRE TO BOARD CONNECTOR SINGLE TYPE	
	REV.		DESCRIPTION	THIS DOCUMENT CONTAINS INFORMATION THAT IS PROPRIETARY TO MOLEX INC. AND SHOULD NOT BE USED WITHOUT WRITTEN PERMISSION
DOCUMENT NUMBER PS-502443-001			FILE NAME PS502443001.doc	SHEET 11 OF 14

製品仕様書



【 9. 取り扱い上の注意事項 INSTRUCTION UPON USAGE 】

- 1. コネクタの詳細な取り扱いにつきましては、別紙の 2.0 W/B CONN. SINGLE のコネクタ取り扱い説明書を参照して下さい。

Please refer to the manual of the 2.0 W/B connector. SINGLE series for the detailed handling of the connector.

- ① 嵌合時にリセハウジングの矢印で示す部位を押し嵌合して下さい。

電線やハウジングのロック部を押しした場合、これらが破損する恐れがありますのでお避け下さい。

Please push the part directed by FIG.1 at the time of mate.

It may damage, when electric wires or lock part of the receptacle housing are pushed.



図 1
FIG.1

- ② コネクタの嵌合を取り外す際は、必ずロックを解除して行って下さい。

電線はまとめて軽くつかみ、指の平全体で、ロック解除用バーをロック保護壁と共に押してロックを解除し、ゆっくり引き抜いてください。

When unmated connectors, positive locks shall be released.

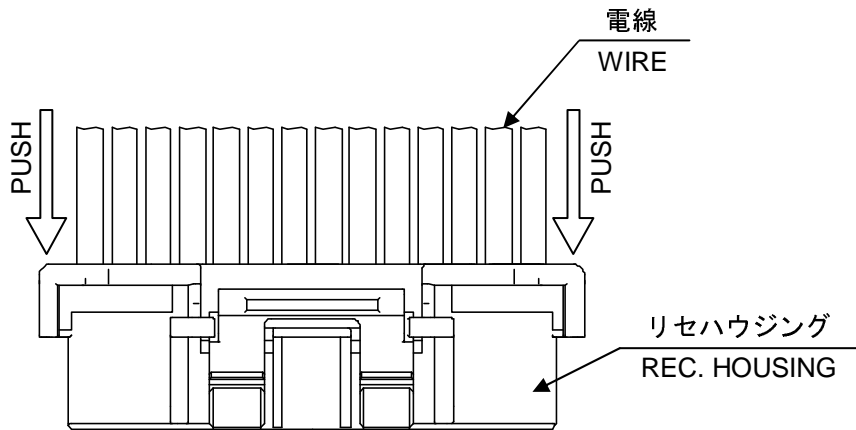
- 2. 平坦度の実装性能は、実装基板の反りの影響を含まないものと致します。

Mounting performance of coplanarity shall not contain the influence of the warpage of the mounting board.

- 3. 本品の平坦度保証につきましては、実装前での保証のみであり、空リフロー中および空リフロー後の平坦度につきましては、保証の限りではありません。

The coplanarity assurance of this product is a guarantee alone before mounting, and the coplanarity during and after the empty reflow is not guaranteed.

REVISE ON PC ONLY		TITLE:	
E	SEE SHEET 1	2.0mm PITCH WIRE TO BOARD CONNECTOR SINGLE TYPE	
	REV.	DESCRIPTION	製品仕様書
DOCUMENT NUMBER PS-502443-001		THIS DOCUMENT CONTAINS INFORMATION THAT IS PROPRIETARY TO MOLEX INC. AND SHOULD NOT BE USED WITHOUT WRITTEN PERMISSION	FILE NAME PS502443001.doc
			SHEET 12 OF 14



- 4. 実装後において手半田コテによるリペアーを行なう際は、必ず仕様書掲載の条件以内で行なって下さい。条件を超えて実施した場合、端子の抜け、接点ギャップの変化、モールドの変形、溶融等が原因により破損の原因になります。

Please conduct it under the condition of the specifications when repairing by hand soldering iron after mounting. In the case of practicing beyond the condition, the backlash, the change in the contact gap, the deformation of the mold and the melting, etc. may cause a damage.

- 5. 弊社の推奨基板パターン寸法を変更して設計を行なう際は、致命的な不良の原因にもなりますのであらかじめご相談下さい。

In the case of changing our recommended board pattern size and designing, please consult in advance because it may cause a fatal defect.

- 6. リフロー条件によっては端子メッキ部にヨリ等が発生する場合がありますが、製品性能には影響はございません。

Strand, etc. may be generated on the terminal plating part according to the reflow condition, however, there is no influence in the product performance.

- 7. リフロー条件によっては樹脂部に変色が発生する場合がありますが、製品性能には影響はございません。

Discoloration may be generated in the resin part according to the reflow condition, however, there is no influence in the product performance.

- 8. 半田上がりについて、「本コネクタは大気リフローでの実装を想定しています。N2リフローで実装した場合、リフロー後、半田上がりを生じる恐れがあります。N2リフローでの実装をお考えの場合、別途評価が必要になります。」

Soldering wicking: "This connector assumes the mounting by an air reflow. In the case of mounting by the N2 reflow, there is a risk of the soldering wicking. The separate evaluation is necessary for mounting by the N2 reflow."

- 9. 推奨メタルマスク厚寸法及び開口率についての記載。又は、弊社評価では厚さT=0.11mm、開口率100%のメタルマスクを使用しております。

Description of size of thickness of recommended metal mask and the aperture ratio. And the metal mask of thickness of T=0.11mm and the aperture ratio of 100% is used in our evaluation.

REVISE ON PC ONLY		TITLE:	
E	SEE SHEET 1	2.0mm PITCH WIRE TO BOARD CONNECTOR SINGLE TYPE	
		製品仕様書	
REV.	DESCRIPTION	THIS DOCUMENT CONTAINS INFORMATION THAT IS PROPRIETARY TO MOLEX INC. AND SHOULD NOT BE USED WITHOUT WRITTEN PERMISSION	
DOCUMENT NUMBER PS-502443-001		FILE NAME PS502443001.doc	SHEET 13 OF 14

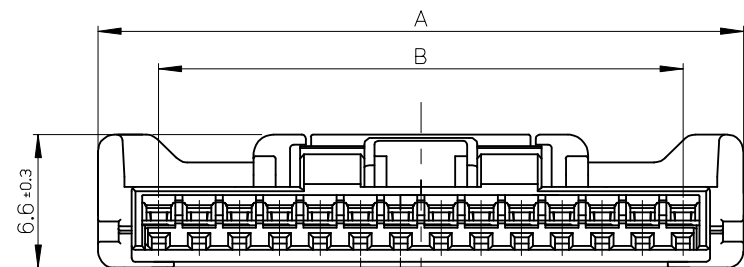
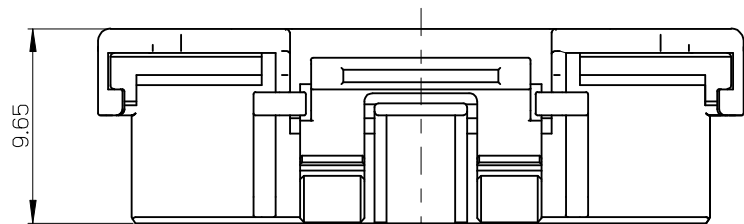

2
PITCH

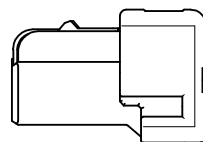
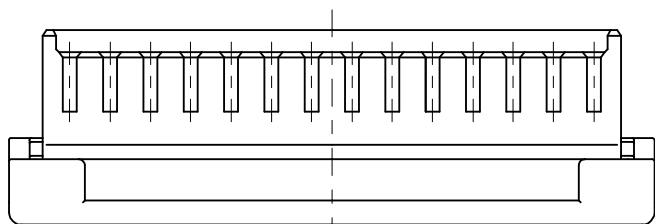

回路番号1
CKT. NO. 1

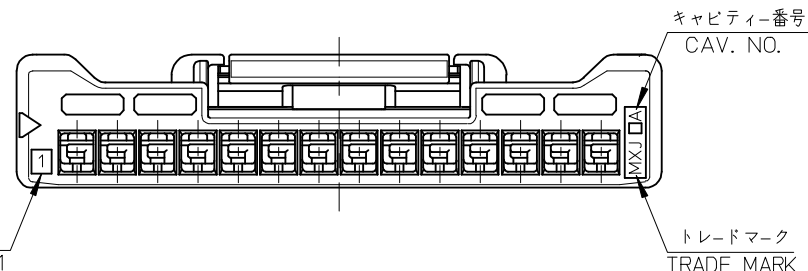

NOTES

- 適合ターミナル : 502438-0*00
APPLICABLE TARMINAL : 502438-0*00
- △ 嵌合相手 : 502443-**70
MATE WITH : 502443-**70
- 極数 / 2 = 偶数に適用。
APPLY FOR CKT. SIZE / 2 = EVEN.
- 本製品のプラスチック部に黒点等が確認される場合や色合いが異なる場合がありますが、製品性能に影響はありません。
THERE IS NO INFLUENCE IN THE PRODUCT PERFORMANCE THOUGH THE BLACK SPOT ETC. MIGHT BE CONFIRMED TO THE PLASTIC PART OF THIS PRODUCT AND THE SHADE MIGHT BE DIFFERENT.
- アプリケーション仕様書 (コネクタ取扱説明書) : AS-502439-001
APPLICATION SPECIFICATIONS (CONNECTOR MANUAL) : AS-502439-001
- 製品仕様書 : PS-502443-001
Product specification : PS-502443-001

26	32	502439-1400	14
24	30	502439-1300	13
22	28	502439-1200	12
14	20	502439-0800	8
10	16	502439-0600	6
8	14	502439-0500	5
6	12	502439-0400	4
B	A	製品番号 MATERIAL NO.	極数 CKT. NO.

REVISED EC NO. J2008-2504 DRAWN: YGOTO 2007/12/25 CHKD: K. ASAKAWA 2007/12/25 APPR: YO ITO 2007/12/25	GENERAL TOLERANCES (UNLESS SPECIFIED)		DIMENSION STYLE MM ONLY	SCALE 4:1	DESIGN UNITS METRIC	THIRD ANGLE PROJECTION
	10 UNDER	±0.2	DRAWN BY NITO	DATE 2006/12/12	TITLE 2.0 W/B CONN. SINGLE PLUG HSG	
	10 OVER 30 UNDER	±0.25	CHECKED BY KASAKAWA	DATE 2006/12/12	MOLEX INCORPORATED	
	30 OVER	±0.3	APPROVED BY YO ITO	DATE 2006/12/12		
ANGULAR ±3 °	DRAFT WHERE APPLICABLE MUST REMAIN WITHIN DIMENSIONS	MATERIAL NO. SEE TABLE	DOCUMENT NO. SD-502439-002	SHEET NO. 1 OF 1		
SIZE A3	THIS DRAWING CONTAINS INFORMATION THAT IS PROPRIETARY TO MOLEX INCORPORATED AND SHOULD NOT BE USED WITHOUT WRITTEN PERMISSION					

部品 PART	材質 MATERIAL
ハウジング HOUSING	ポリブチレンテレフタレート UL94V-0 色: 白 POLYBUTYLENE TEREPHTHALATE UL94V-0 COLOR: WHITE