

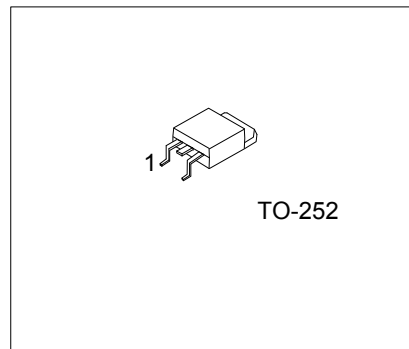

2SB1182

PNP SILICON TRANSISTOR

MEDIUM POWER LOW VOLTAGE TRANSISTOR



DESCRIPTION

The UTC **2SB1182** is a medium power low voltage transistor, designed for audio power amplifier, DC-DC converter and voltage regulator.

FEATURES

- * High current output up to 3A
- * Low saturation voltage

ORDERING INFORMATION

Ordering Number		Package	Pin Assignment			Packing
Lead Free	Halogen Free		1	2	3	
2SB1182L-x-TN3-R	2SB1182G-x-TN3-R	TO-252	B	C	E	Tape Reel
2SB1182L-x-TN3-T	2SB1182G-x-TN3-T	TO-252	B	C	E	Tube

<p>2SB1182L-x-TN3-R</p>	<p>(1) T: Tube, R: Tape Reel (2) TN3: TO-252 (3) x: refer to Classification of h_{FE2} (4) G: Halogen Free, L: Lead Free</p>
-------------------------	--

■ ABSOLUTE MAXIMUM RATINGS ($T_A = 25^\circ\text{C}$, unless otherwise specified)

PARAMETER		SYMBOL	RATINGS	UNIT
Collector-Base Voltage		V_{CBO}	-40	V
Collector-Emitter Voltage		V_{CEO}	-32	V
Emitter-Base Voltage		V_{EBO}	-5	V
Collector Current	DC	I_C	-2	A
	Pulse	I_{CP}	-3	A
Base Current		I_B	-0.6	A
Collector Dissipation ($T_A=25^\circ\text{C}$)		P_C	10	W
Junction Temperature		T_J	+150	$^\circ\text{C}$
Storage Temperature		T_{STG}	-55 ~ +150	$^\circ\text{C}$

Note Absolute maximum ratings are those values beyond which the device could be permanently damaged.

Absolute maximum ratings are stress ratings only and functional device operation is not implied.

■ ELECTRICAL CHARACTERISTICS ($T_A = 25^\circ\text{C}$, unless otherwise specified)

PARAMETER	SYMBOL	TEST CONDITIONS	MIN	TYP	MAX	UNIT
Collector-Base Breakdown Voltage	BV_{CBO}	$I_C = -50\mu\text{A}$	-40			V
Collector-Emitter Breakdown Voltage	BV_{CEO}	$I_C = -1\text{mA}$	-32			V
Emitter-Base Breakdown Voltage	BV_{EBO}	$I_E = -50\mu\text{A}$	-5			V
Collector Cut-Off Current	I_{CBO}	$V_{CB} = -20\text{V}$			-1	μA
Collector Cut-Off Current	I_{CEO}	$V_{CE} = -20\text{V}$			-1	μA
Emitter Cut-Off Current	I_{EBO}	$V_{EB} = -4\text{V}$			-1	μA
DC Current Gain(Note 1)	h_{FE}	$V_{CE} = -3\text{V}$, $I_C = -0.5\text{A}$	120		390	
Collector-Emitter Saturation Voltage	$V_{CE(SAT)}$	$I_C = -2\text{A}$, $I_B = -0.2\text{A}$		-0.5	-0.8	V
Base-Emitter Saturation Voltage	$V_{BE(SAT)}$	$I_C = -2\text{A}$, $I_B = -0.2\text{A}$		-1.0	-2.0	V
Current Gain Bandwidth Product	f_T	$V_{CE} = -5\text{V}$, $I_E = 0.5\text{A}$, $f = 100\text{MHz}$		100		MHz
Output Capacitance	C_{OB}	$V_{CB} = -10\text{V}$, $I_E = 0\text{A}$, $f = 1\text{MHz}$		50		pF

Note 1: Pulse test: $P_W < 300\mu\text{s}$, Duty Cycle $< 2\%$

■ CLASSIFICATION OF h_{FE2}

RANK	Q	R
RANGE	120 ~ 270	180 ~ 390

TYPICAL CHARACTERISTICS

Static Characteristics

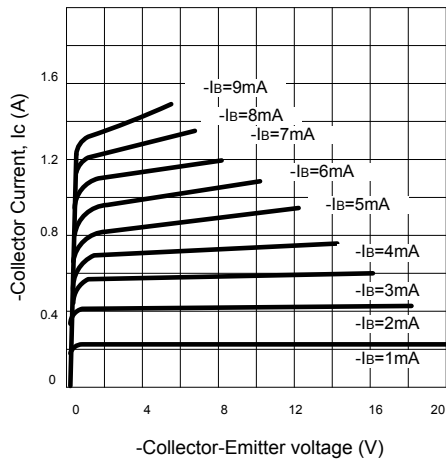

Derating Curve of Safe Operating Areas

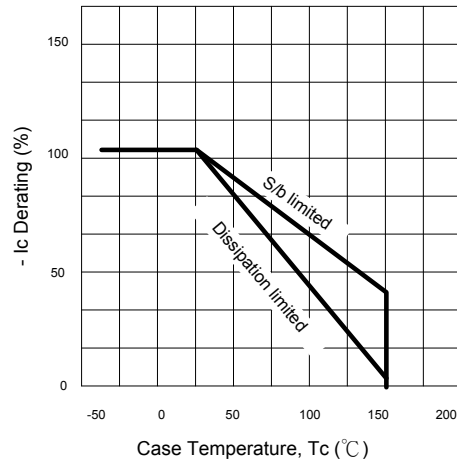

Power Derating

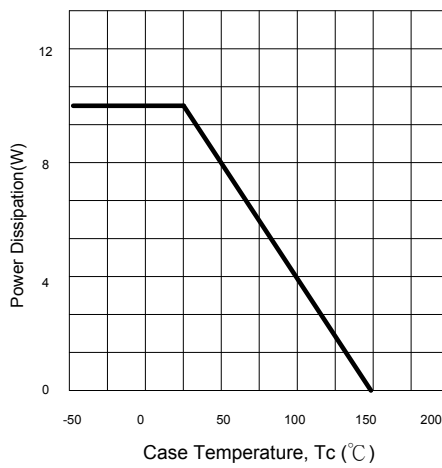

Collector Output Capacitance

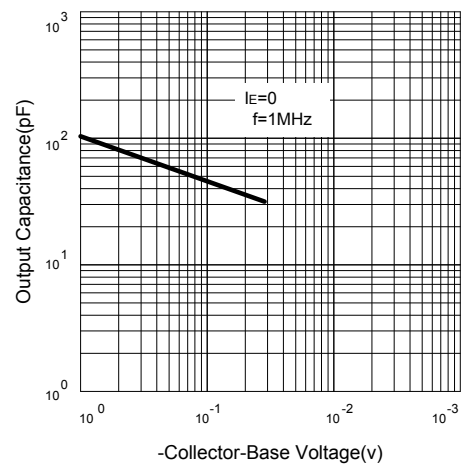

Current Gain-Bandwidth Product

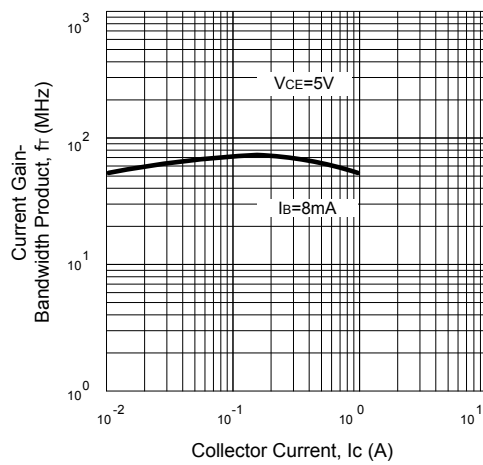

Safe Operating Area

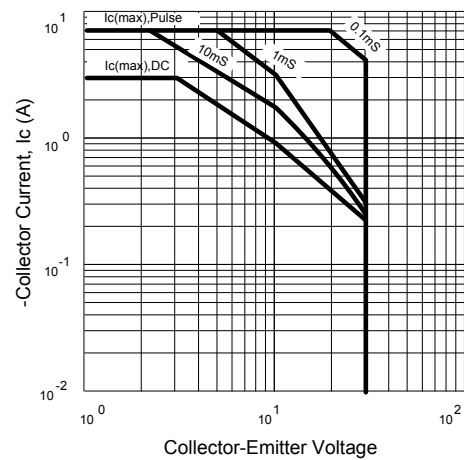

■ TYPICAL CHARACTERISTICS(Cont.)

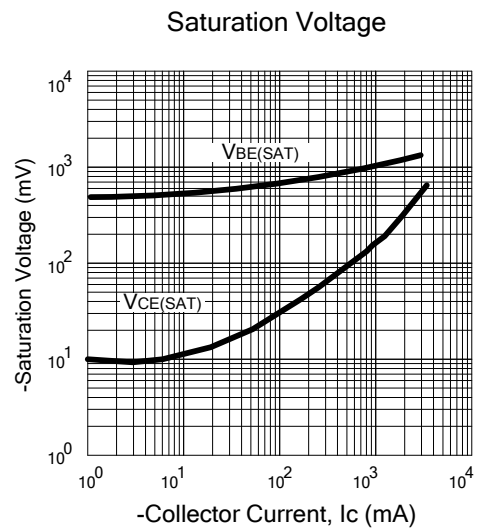
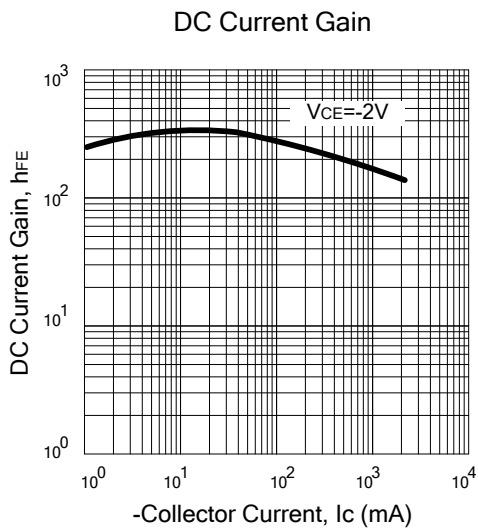

UTC assumes no responsibility for equipment failures that result from using products at values that exceed, even momentarily, rated values (such as maximum ratings, operating condition ranges, or other parameters) listed in products specifications of any and all UTC products described or contained herein. UTC products are not designed for use in life support appliances, devices or systems where malfunction of these products can be reasonably expected to result in personal injury. Reproduction in whole or in part is prohibited without the prior written consent of the copyright owner. The information presented in this document does not form part of any quotation or contract, is believed to be accurate and reliable and may be changed without notice.