

## Super Fast Recovery Diode, 200A

### Features

- Dual Diode Construction
- Low Leakage Current
- Low forward voltage drop
- High surge current capability
- Super Fast Switching



TWIN TOWER PACKAGE

Maximum Ratings ( $T_J = 25^\circ\text{C}$ unless otherwise specified)					
Parameter	Symbol	Conditions	MUR20040CT(R)	MUR20060CT(R)	Units
Repetitive peak reverse voltage	$V_{RRM}$		400	600	V
RMS reverse voltage	$V_{RMS}$		280	420	V
DC blocking voltage	$V_{DC}$		400	600	V
Average forward current	$I_{F(AV)}$	$T_C \leq 140^\circ\text{C}$	200	200	A
Non-repetitive forward surge current, half sine-wave	$I_{FSM}$	$T_C = 25^\circ\text{C}$	800	800	A

Electrical Characteristics ( $T_J = 25^\circ\text{C}$ unless otherwise specified)					
Parameter	Symbol	Conditions	MUR20040CT(R)	MUR20060CT(R)	Units
DC forward voltage	$V_F$	$I_F = 50\text{ A}$ $T_J = 25^\circ\text{C}$	1.3	1.7	V
DC reverse current	$I_R$	$V_R = 50\text{ V}$ $T_J = 25^\circ\text{C}$	25	25	$\mu\text{A}$
		$V_R = 50\text{ V}$ $T_J = 125^\circ\text{C}$	1	1	mA
Maximum Reverse Recovery Time	$t_{rr}$	$I_F = 0.5\text{ A}$ $I_R = 1.0\text{ A}$ $I_{RR} = 0.25\text{ A}$	90	110	nS

Thermal Characteristics ( $T_J = 25^\circ\text{C}$ unless otherwise specified)					
Parameter	Symbol		MUR20040CT(R)	MUR20060CT(R)	Units
Thermal resistance junction to case	$R_{thj-c}$		1.0	1.0	$^\circ\text{C/W}$
Operating, storage temperature range	$T_J, T_{stg}$		- 40 to +175	- 40 to +175	$^\circ\text{C}$



Package Outline

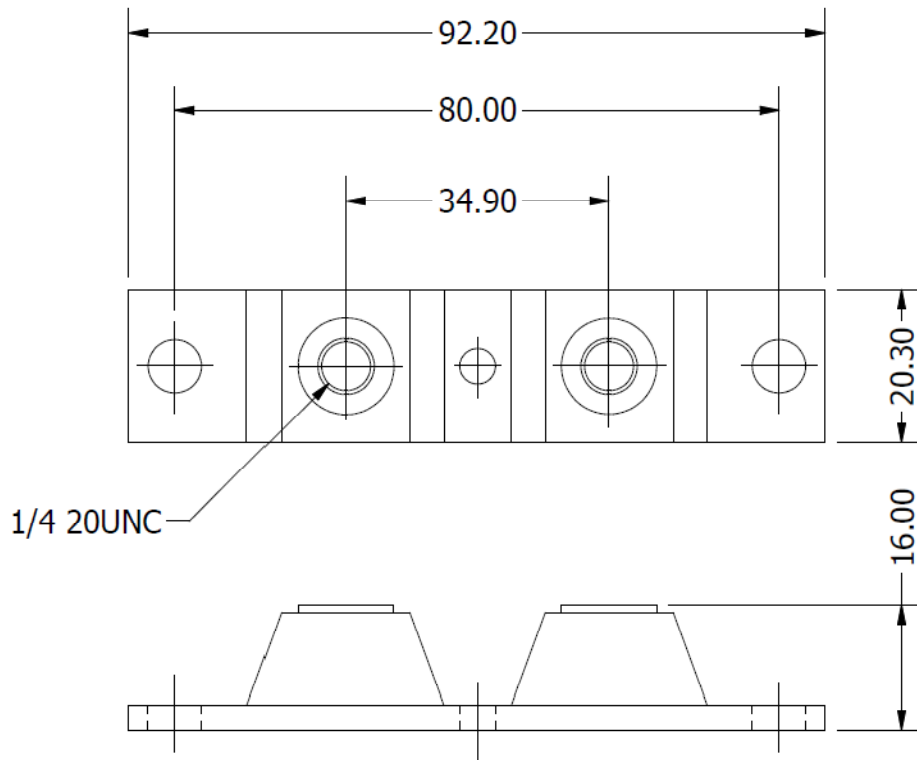

ALL DIMENSIONS IN MM

Ordering Table

MUR	200	40	CT
1	2	3	4

- 1 – Device Type
  - > MUR = Dual Diode Recovery Module
- 2 – Current Rating =  $I_{F(AV)}$
- 3 – Voltage = code x 10 =  $V_{RRM}$
- 4 – Polarity
  - > CT = Normal (Cathode to Base)
  - > CTR = Reverse (Anode to Base)