

MMBT3904WT1, NPN MMBT3906WT1, PNP

General Purpose Transistors

NPN and PNP Silicon

These transistors are designed for general purpose amplifier applications. They are housed in the SOT-323/SC-70 package which is designed for low power surface mount applications.

- Pb-Free Packages are Available

MAXIMUM RATINGS

Rating	Symbol	Value	Unit
Collector–Emitter Voltage MMBT3904WT1 MMBT3906WT1	V_{CEO}	40 –40	Vdc
Collector–Base Voltage MMBT3904WT1 MMBT3906WT1	V_{CBO}	60 –40	Vdc
Emitter–Base Voltage MMBT3904WT1 MMBT3906WT1	V_{EBO}	6.0 –5.0	Vdc
Collector Current – Continuous MMBT3904WT1 MMBT3906WT1	I_C	200 –200	mAdc

THERMAL CHARACTERISTICS

Characteristic	Symbol	Max	Unit
Total Device Dissipation (Note 1) $T_A = 25^\circ\text{C}$	P_D	150	mW
Thermal Resistance, Junction to Ambient	$R_{\theta JA}$	833	$^\circ\text{C/W}$
Junction and Storage Temperature	T_J, T_{stg}	–55 to +150	$^\circ\text{C}$

- Device mounted on FR4 glass epoxy printed circuit board using the minimum recommended footprint.



ON Semiconductor®

<http://onsemi.com>

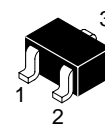
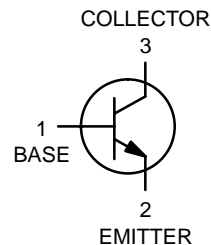

SC-70/SOT-323
CASE 419
STYLE 3

MARKING DIAGRAM

MMBT3904WT1

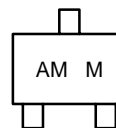

MMBT3906WT1

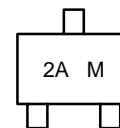

AM = Specific Device Code
2A = Specific Device Code
M = Date Code

ORDERING INFORMATION

Device	Package	Shipping†
MMBT3904WT1	SC-70	3000/Tape & Reel
MMBT3906WT1	SC-70	3000/Tape & Reel
MMBT3904WT1G	SC-70	3000/Tape & Reel
MMBT3906WT1G	SC-70	3000/Tape & Reel

†For information on tape and reel specifications, including part orientation and tape sizes, please refer to our Tape and Reel Packaging Specification Brochure, BRD8011/D.

MMBT3904WT1, NPN MMBT3906WT1, PNP

ELECTRICAL CHARACTERISTICS (T_A = 25°C unless otherwise noted)

Characteristic	Symbol	Min	Max	Unit	
OFF CHARACTERISTICS					
Collector–Emitter Breakdown Voltage (Note 2) (I _C = 1.0 mA, I _B = 0) (I _C = -1.0 mA, I _B = 0)	MMBT3904WT1 MMBT3906WT1	V _{(BR)CEO}	40 -40	- -	Vdc
Collector–Base Breakdown Voltage (I _C = 10 μA, I _E = 0) (I _C = -10 μA, I _E = 0)	MMBT3904WT1 MMBT3906WT1	V _{(BR)CBO}	60 -40	- -	Vdc
Emitter–Base Breakdown Voltage (I _E = 10 μA, I _C = 0) (I _E = -10 μA, I _C = 0)	MMBT3904WT1 MMBT3906WT1	V _{(BR)EBO}	6.0 -5.0	- -	Vdc
Base Cutoff Current (V _{CE} = 30 Vdc, V _{EB} = 3.0 Vdc) (V _{CE} = -30 Vdc, V _{EB} = -3.0 Vdc)	MMBT3904WT1 MMBT3906WT1	I _{BL}	- -	50 -50	nAdc
Collector Cutoff Current (V _{CE} = 30 Vdc, V _{EB} = 3.0 Vdc) (V _{CE} = -30 Vdc, V _{EB} = -3.0 Vdc)	MMBT3904WT1 MMBT3906WT1	I _{CEX}	- -	50 -50	nAdc
ON CHARACTERISTICS (Note 2)					
DC Current Gain (I _C = 0.1 mA, V _{CE} = 1.0 Vdc) (I _C = 1.0 mA, V _{CE} = 1.0 Vdc) (I _C = 10 mA, V _{CE} = 1.0 Vdc) (I _C = 50 mA, V _{CE} = 1.0 Vdc) (I _C = 100 mA, V _{CE} = 1.0 Vdc) (I _C = -0.1 mA, V _{CE} = -1.0 Vdc) (I _C = -1.0 mA, V _{CE} = -1.0 Vdc) (I _C = -10 mA, V _{CE} = -1.0 Vdc) (I _C = -50 mA, V _{CE} = -1.0 Vdc) (I _C = -100 mA, V _{CE} = -1.0 Vdc)	MMBT3904WT1 MMBT3906WT1	h _{FE}	40 70 100 60 30 60 80 100 60 30	- - 300 - - - - 300 - -	-
Collector–Emitter Saturation Voltage (I _C = 10 mA, I _B = 1.0 mA) (I _C = 50 mA, I _B = 5.0 mA) (I _C = -10 mA, I _B = -1.0 mA) (I _C = -50 mA, I _B = -5.0 mA)	MMBT3904WT1 MMBT3906WT1	V _{CE(sat)}	- - - -	0.2 0.3 -0.25 -0.4	Vdc
Base–Emitter Saturation Voltage (I _C = 10 mA, I _B = 1.0 mA) (I _C = 50 mA, I _B = 5.0 mA) (I _C = -10 mA, I _B = -1.0 mA) (I _C = -50 mA, I _B = -5.0 mA)	MMBT3904WT1 MMBT3906WT1	V _{BE(sat)}	0.65 - -0.65 -	0.85 0.95 -0.85 -0.95	Vdc

2. Pulse Test: Pulse Width ≤ 300 μs; Duty Cycle ≤ 2.0%.

MMBT3904WT1, NPN MMBT3906WT1, PNP

ELECTRICAL CHARACTERISTICS (T_A = 25°C unless otherwise noted) (Continued)

Characteristic		Symbol	Min	Max	Unit
SMALL-SIGNAL CHARACTERISTICS					
Current-Gain – Bandwidth Product (I _C = 10 mA, V _{CE} = 20 Vdc, f = 100 MHz) (I _C = -10 mA, V _{CE} = -20 Vdc, f = 100 MHz)	MMBT3904WT1 MMBT3906WT1	f _T	300 250	– –	MHz
Output Capacitance (V _{CB} = 5.0 Vdc, I _E = 0, f = 1.0 MHz) (V _{CB} = -5.0 Vdc, I _E = 0, f = 1.0 MHz)	MMBT3904WT1 MMBT3906WT1	C _{obo}	– –	4.0 4.5	pF
Input Capacitance (V _{EB} = 0.5 Vdc, I _C = 0, f = 1.0 MHz) (V _{EB} = -0.5 Vdc, I _C = 0, f = 1.0 MHz)	MMBT3904WT1 MMBT3906WT1	C _{ibo}	– –	8.0 10.0	pF
Input Impedance (V _{CE} = 10 Vdc, I _C = 1.0 mA, f = 1.0 kHz) (V _{CE} = -10 Vdc, I _C = -1.0 mA, f = 1.0 kHz)	MMBT3904WT1 MMBT3906WT1	h _{ie}	1.0 2.0	10 12	k Ω
Voltage Feedback Ratio (V _{CE} = 10 Vdc, I _C = 1.0 mA, f = 1.0 kHz) (V _{CE} = -10 Vdc, I _C = -1.0 mA, f = 1.0 kHz)	MMBT3904WT1 MMBT3906WT1	h _{re}	0.5 0.1	8.0 10	X 10 ⁻⁴
Small-Signal Current Gain (V _{CE} = 10 Vdc, I _C = 1.0 mA, f = 1.0 kHz) (V _{CE} = -10 Vdc, I _C = -1.0 mA, f = 1.0 kHz)	MMBT3904WT1 MMBT3906WT1	h _{fe}	100 100	400 400	–
Output Admittance (V _{CE} = 10 Vdc, I _C = 1.0 mA, f = 1.0 kHz) (V _{CE} = -10 Vdc, I _C = -1.0 mA, f = 1.0 kHz)	MMBT3904WT1 MMBT3906WT1	h _{oe}	1.0 3.0	40 60	μmhos
Noise Figure (V _{CE} = 5.0 Vdc, I _C = 100 μA, R _S = 1.0 k Ω, f = 1.0 kHz) (V _{CE} = -5.0 Vdc, I _C = -100 μA, R _S = 1.0 k Ω, f = 1.0 kHz)	MMBT3904WT1 MMBT3906WT1	NF	– –	5.0 4.0	dB

SWITCHING CHARACTERISTICS

Characteristic	Condition	Symbol	Min	Max	Unit
Delay Time	(V _{CC} = 3.0 Vdc, V _{BE} = -0.5 Vdc) (V _{CC} = -3.0 Vdc, V _{BE} = 0.5 Vdc)	t _d	– –	35 35	ns
Rise Time	(I _C = 10 mA, I _{B1} = 1.0 mA) (I _C = -10 mA, I _{B1} = -1.0 mA)	t _r	– –	35 35	
Storage Time	(V _{CC} = 3.0 Vdc, I _C = 10 mA) (V _{CC} = -3.0 Vdc, I _C = -10 mA)	t _s	– –	200 225	ns
Fall Time	(I _{B1} = I _{B2} = 1.0 mA) (I _{B1} = I _{B2} = -1.0 mA)	t _f	– –	50 75	

MMBT3904WT1

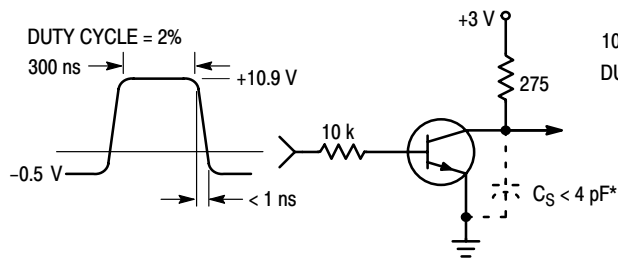

Figure 1. Delay and Rise Time Equivalent Test Circuit

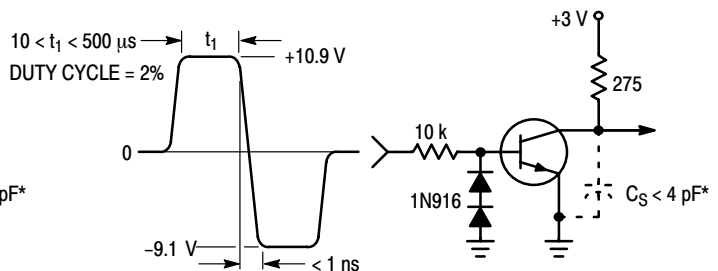

Figure 2. Storage and Fall Time Equivalent Test Circuit

* Total shunt capacitance of test jig and connectors

MMBT3904WT1, NPN MMBT3906WT1, PNP

MMBT3904WT1

TYPICAL TRANSIENT CHARACTERISTICS

— $T_J = 25^\circ\text{C}$
 - - - $T_J = 125^\circ\text{C}$

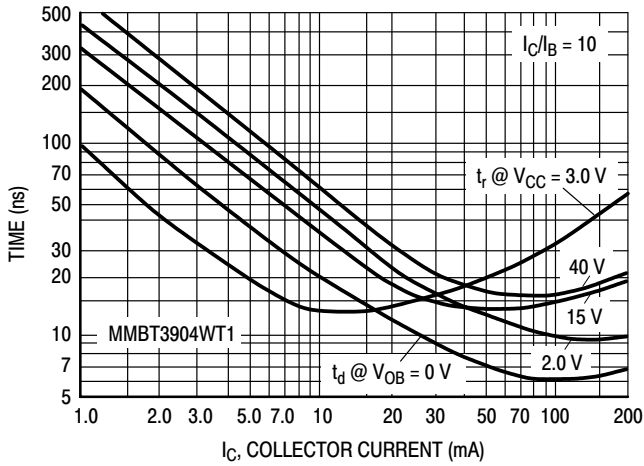

Figure 3. Turn-On Time

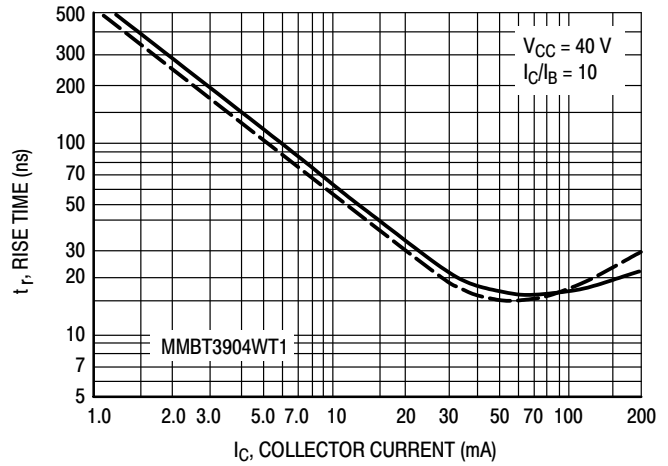

Figure 4. Rise Time

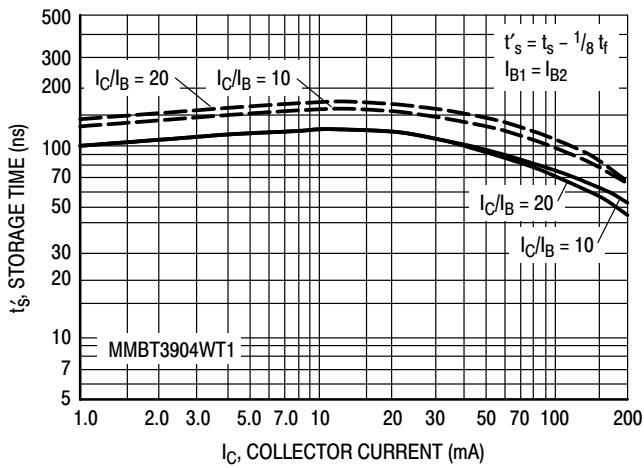

Figure 5. Storage Time

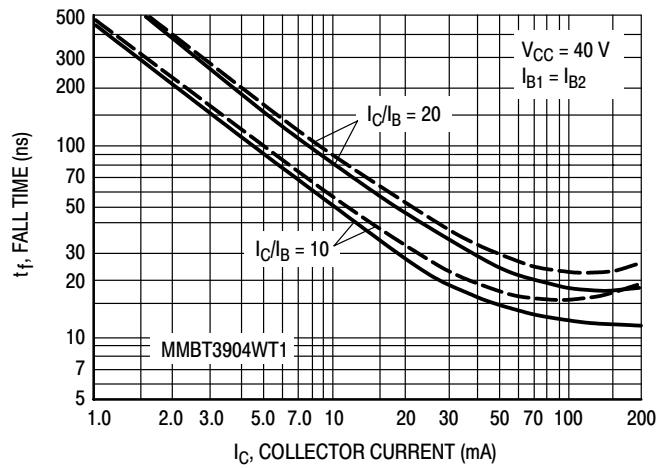

Figure 6. Fall Time

MMBT3904WT1, NPN MMBT3906WT1, PNP

MMBT3904WT1

TYPICAL AUDIO SMALL-SIGNAL CHARACTERISTICS NOISE FIGURE VARIATIONS

($V_{CE} = 5.0$ Vdc, $T_A = 25^\circ\text{C}$, Bandwidth = 1.0 Hz)

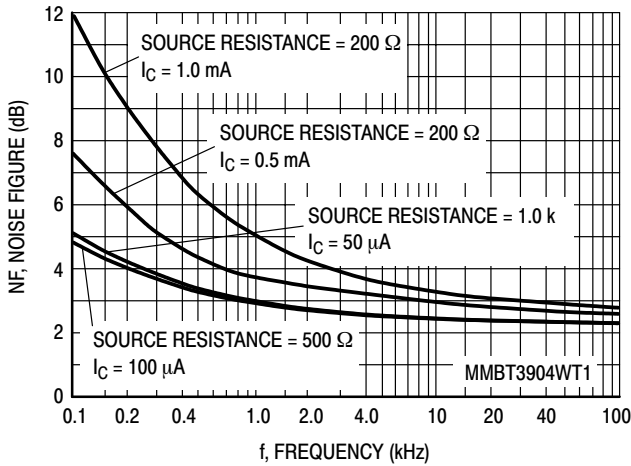

Figure 7. Noise Figure

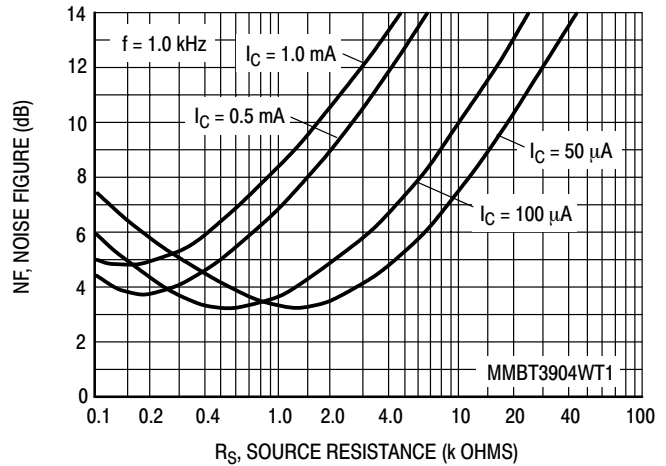

Figure 8. Noise Figure

h PARAMETERS

($V_{CE} = 10$ Vdc, $f = 1.0$ kHz, $T_A = 25^\circ\text{C}$)

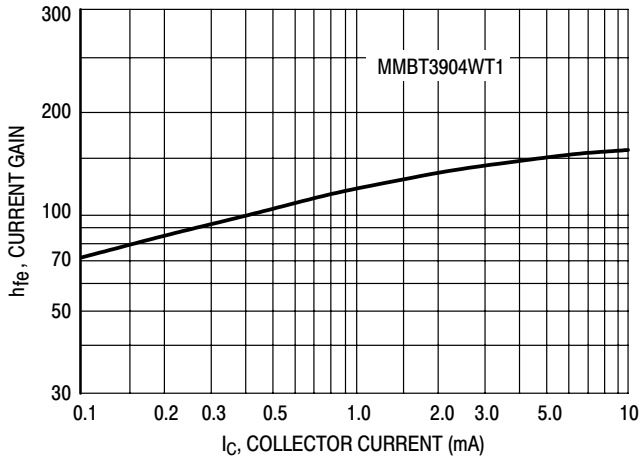

Figure 9. Current Gain

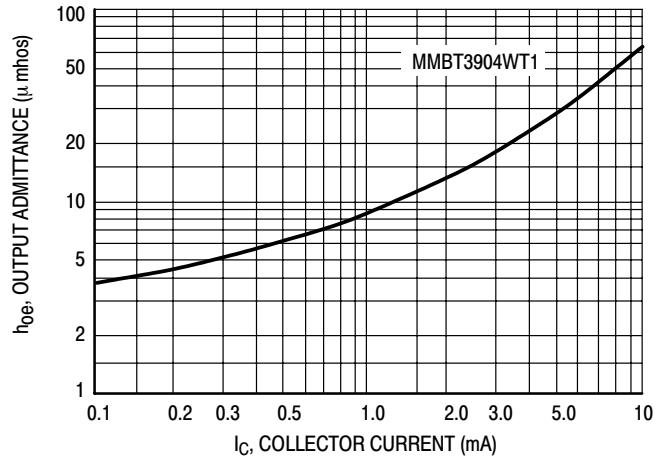

Figure 10. Output Admittance

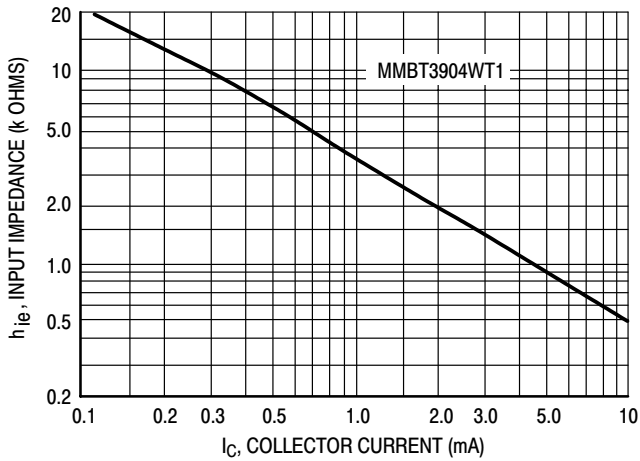

Figure 11. Input Impedance

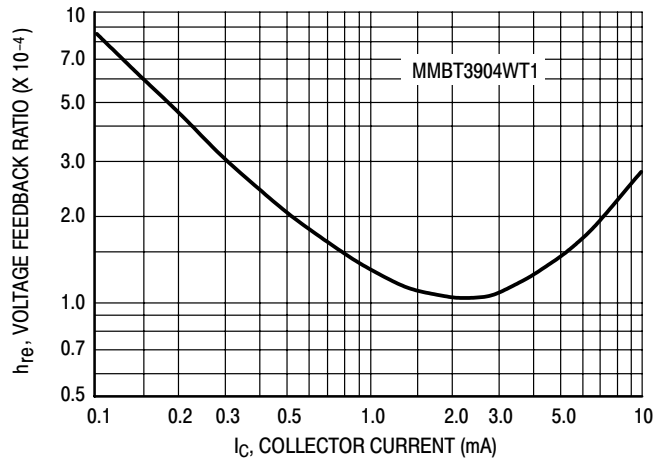

Figure 12. Voltage Feedback Ratio

MMBT3904WT1, NPN MMBT3906WT1, PNP

MMBT3904WT1

TYPICAL STATIC CHARACTERISTICS

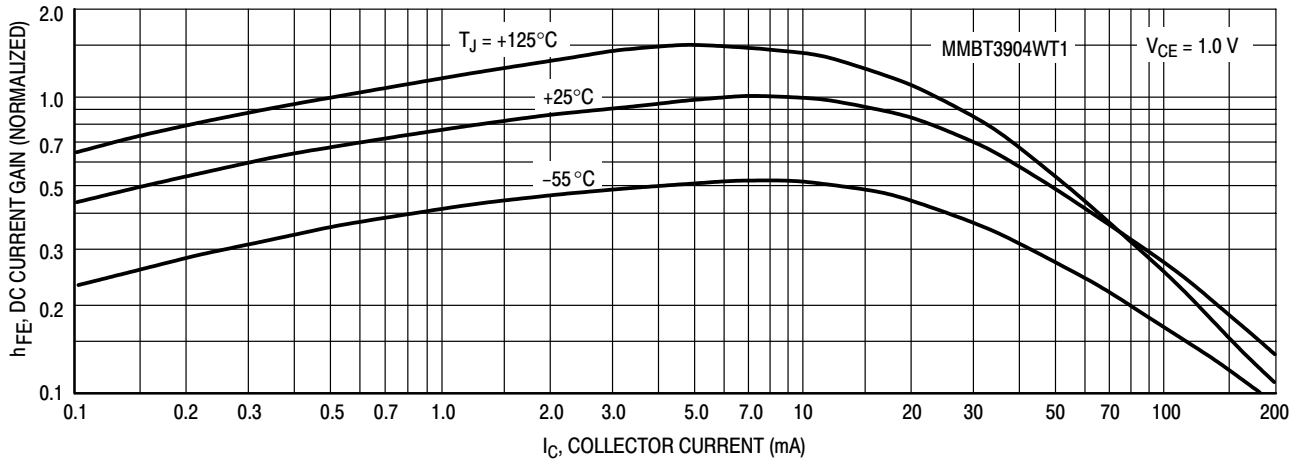

Figure 13. DC Current Gain

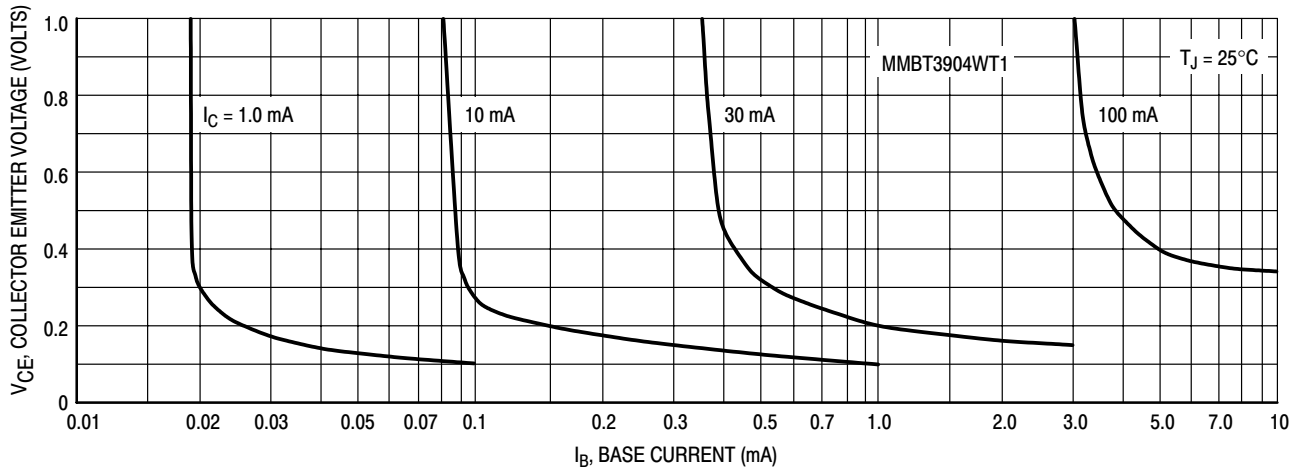

Figure 14. Collector Saturation Region

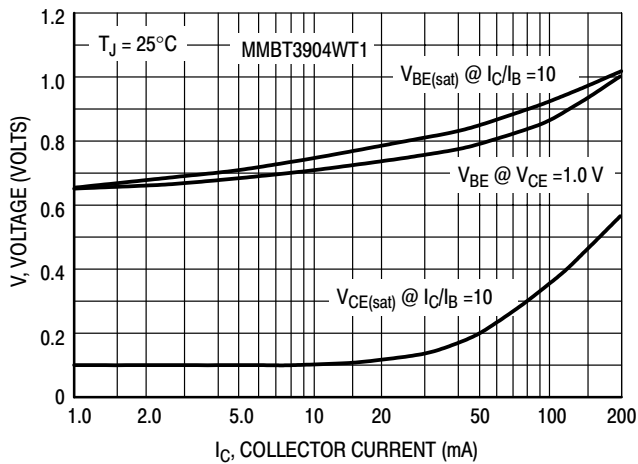

Figure 15. "ON" Voltages

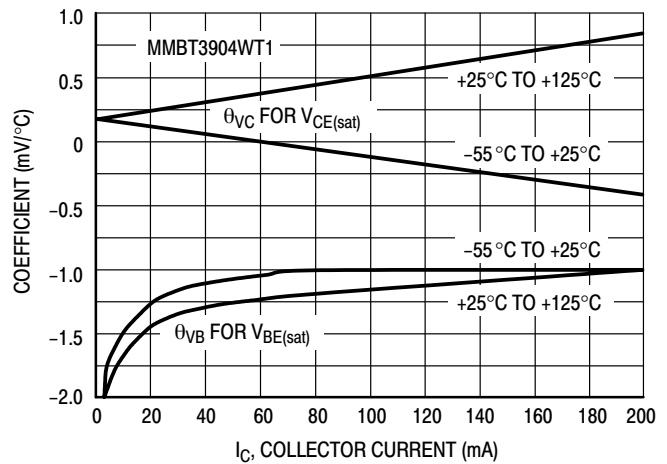

Figure 16. Temperature Coefficients

MMBT3904WT1, NPN MMBT3906WT1, PNP

MMBT3904WT1

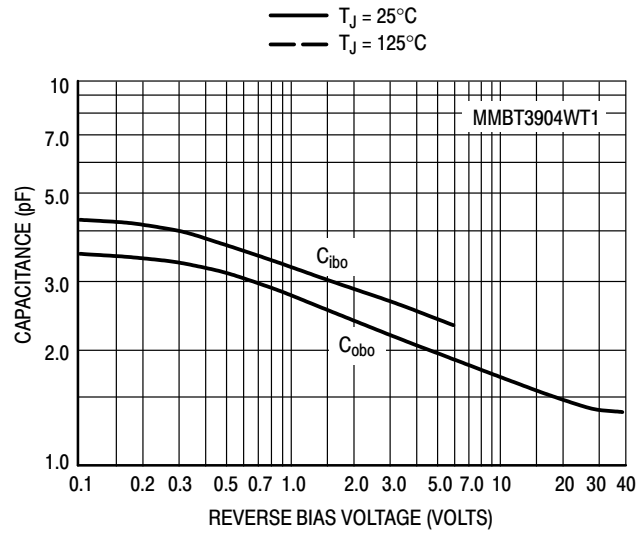

Figure 17. Capacitance

MMBT3904WT1, NPN MMBT3906WT1, PNP

MMBT3906WT1

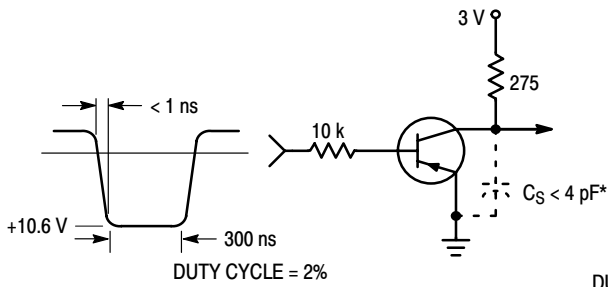

Figure 18. Delay and Rise Time Equivalent Test Circuit

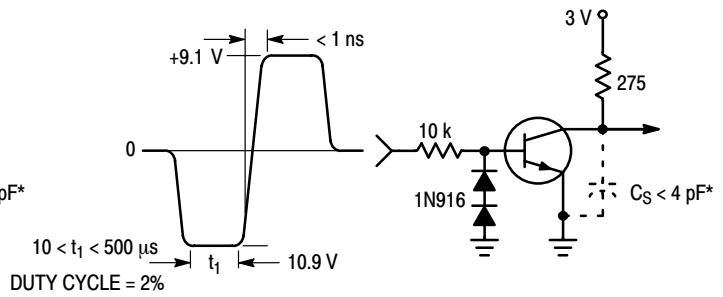

Figure 19. Storage and Fall Time Equivalent Test Circuit

* Total shunt capacitance of test jig and connectors

TYPICAL TRANSIENT CHARACTERISTICS

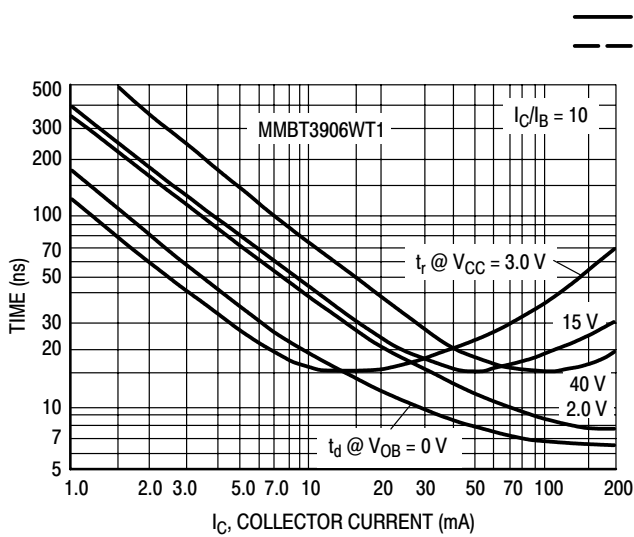

Figure 20. Turn-On Time

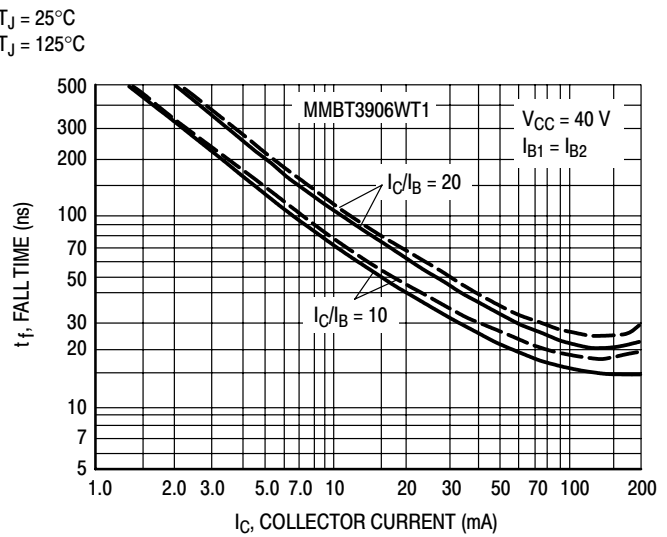

Figure 21. Fall Time

MMBT3906WT1

TYPICAL AUDIO SMALL-SIGNAL CHARACTERISTICS NOISE FIGURE VARIATIONS

($V_{CE} = -5.0$ Vdc, $T_A = 25^\circ\text{C}$, Bandwidth = 1.0 Hz)

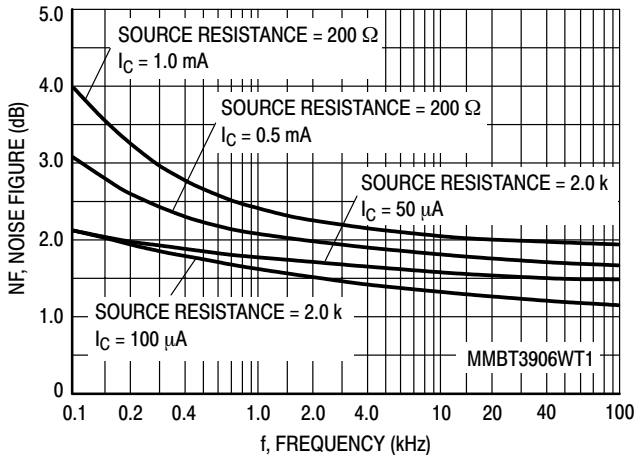

Figure 22.

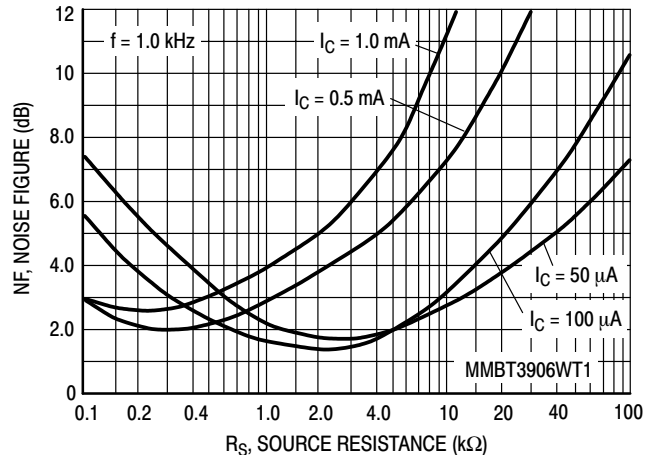

Figure 23.

MMBT3904WT1, NPN MMBT3906WT1, PNP

MMBT3906WT1

h PARAMETERS

($V_{CE} = -10$ Vdc, $f = 1.0$ kHz, $T_A = 25^\circ\text{C}$)

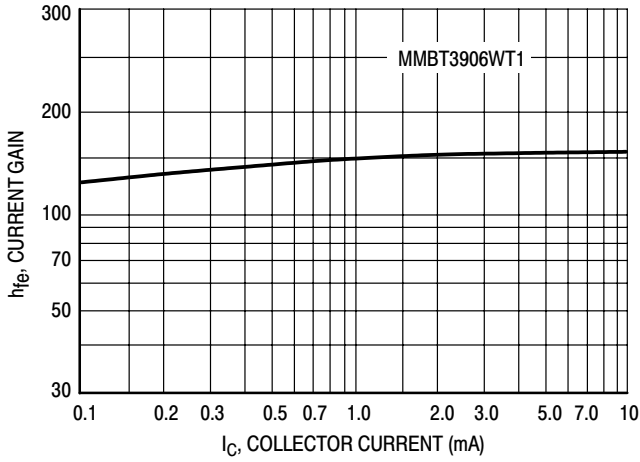

Figure 24. Current Gain

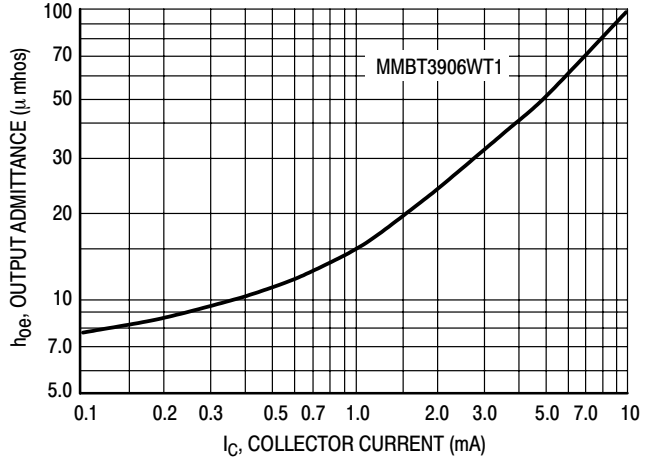

Figure 25. Output Admittance

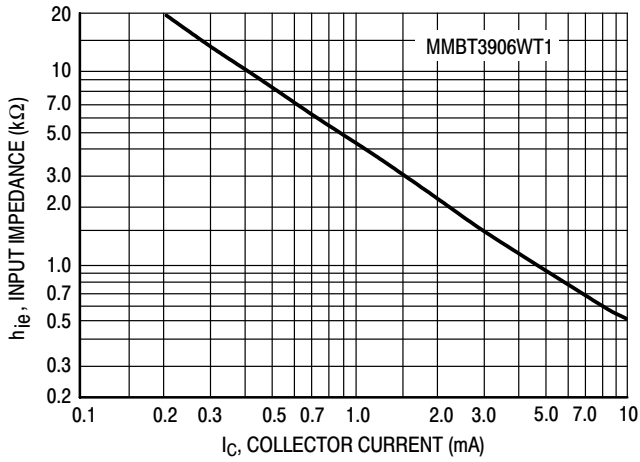

Figure 26. Input Impedance

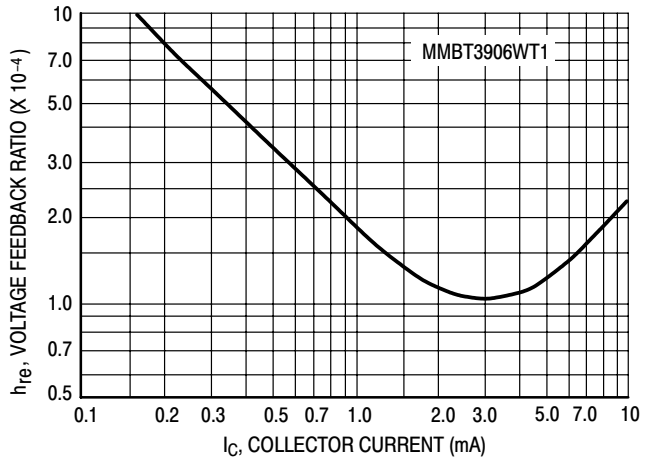

Figure 27. Voltage Feedback Ratio

MMBT3904WT1, NPN MMBT3906WT1, PNP

MMBT3906WT1

STATIC CHARACTERISTICS

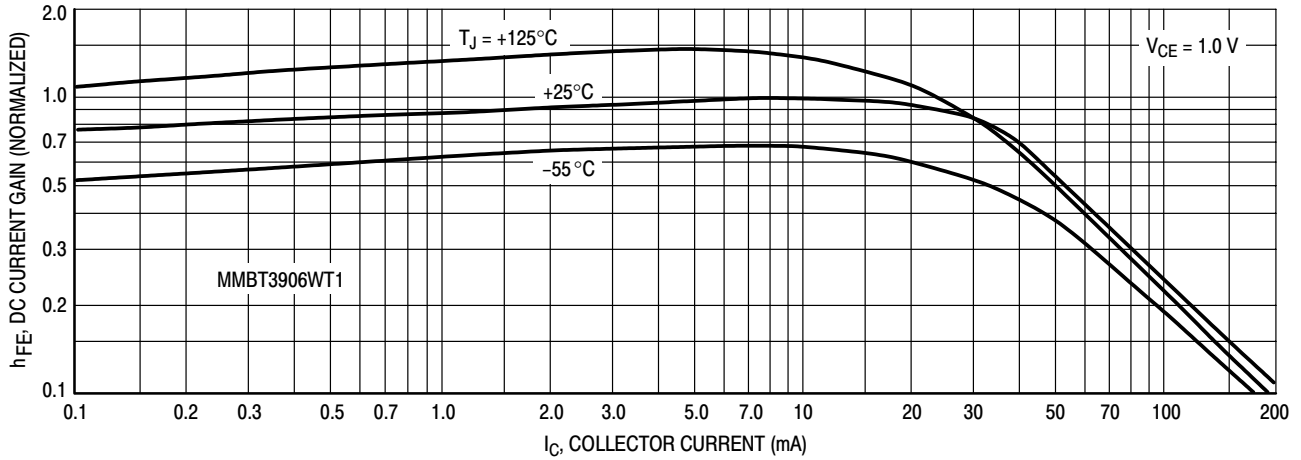

Figure 28. DC Current Gain

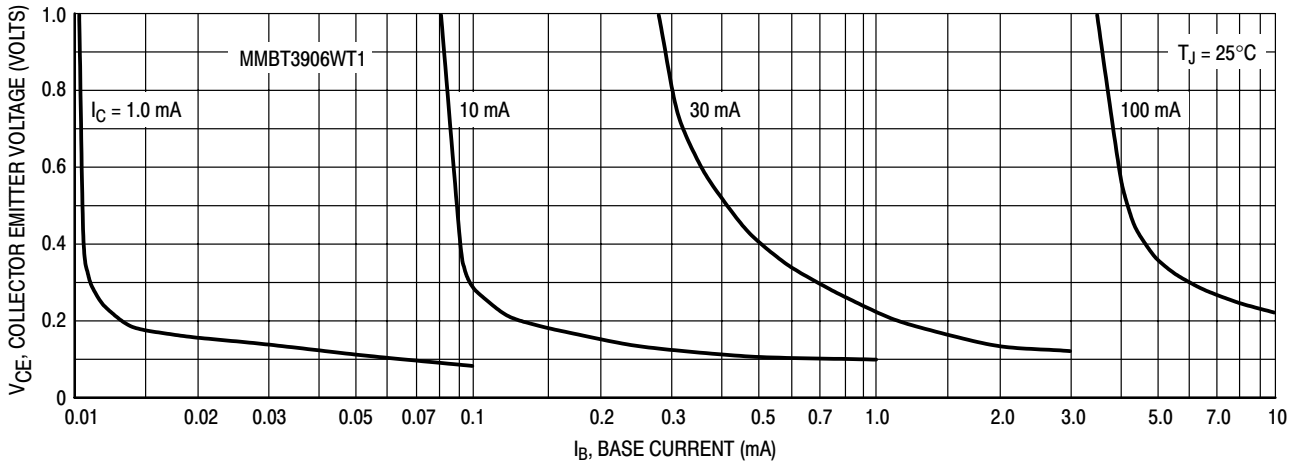

Figure 29. Collector Saturation Region

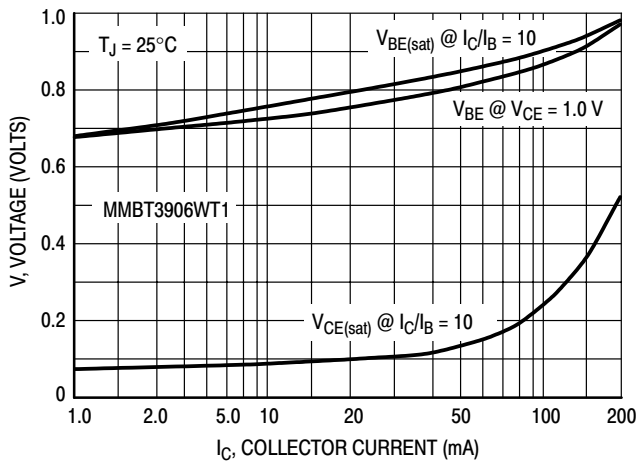

Figure 30. "ON" Voltages

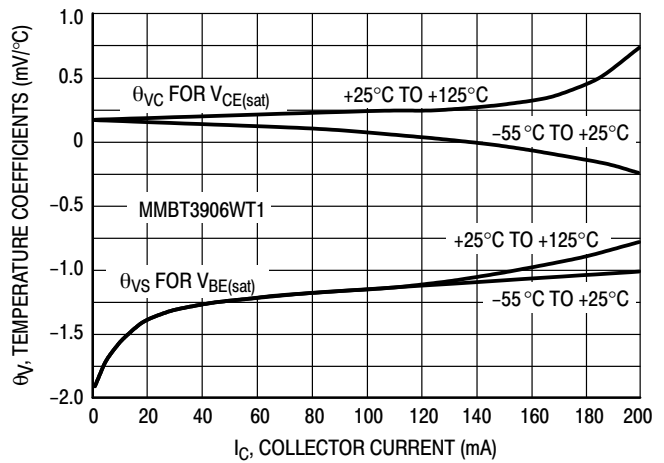

Figure 31. Temperature Coefficients

MMBT3904WT1, NPN MMBT3906WT1, PNP

MMBT3906WT1

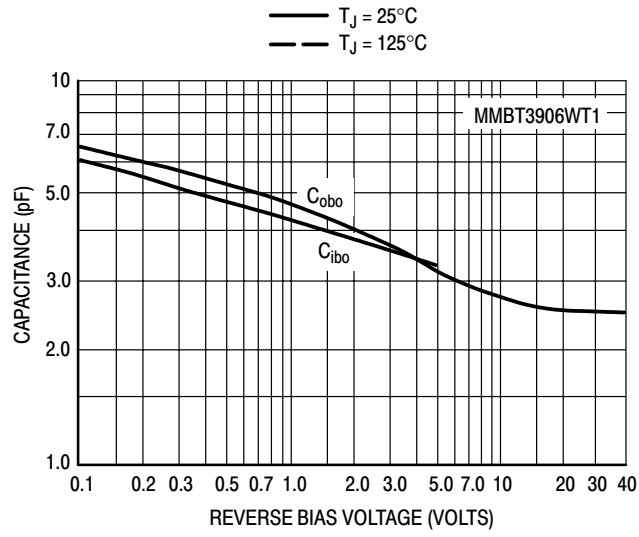
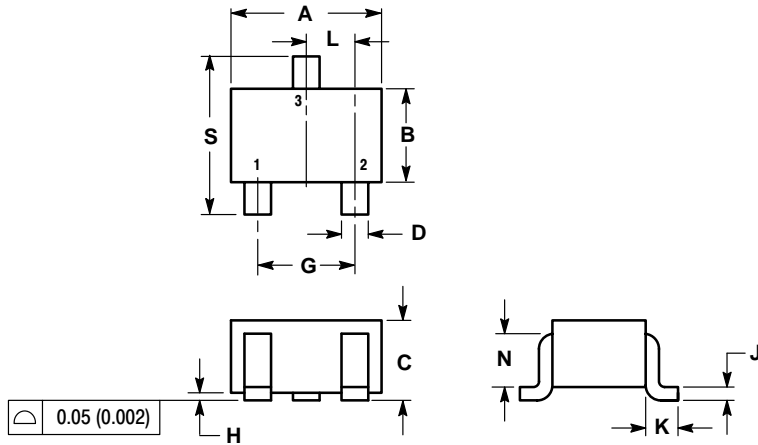

Figure 32. Capacitance

MMBT3904WT1, NPN MMBT3906WT1, PNP

PACKAGE DIMENSIONS

SC-70/SOT-323
CASE 419-04
ISSUE L



- NOTES:
1. DIMENSIONING AND TOLERANCING PER ANSI Y14.5M, 1982.
2. CONTROLLING DIMENSION: INCH.

DIM	INCHES		MILLIMETERS	
	MIN	MAX	MIN	MAX
A	0.071	0.087	1.80	2.20
B	0.045	0.053	1.15	1.35
C	0.032	0.040	0.80	1.00
D	0.012	0.016	0.30	0.40
G	0.047	0.055	1.20	1.40
H	0.000	0.004	0.00	0.10
J	0.004	0.010	0.10	0.25
K	0.017 REF		0.425 REF	
L	0.026 BSC		0.650 BSC	
N	0.028 REF		0.700 REF	
S	0.079	0.095	2.00	2.40

- STYLE 3:
PIN 1. BASE
2. EMITTER
3. COLLECTOR

SOLDERING FOOTPRINT*

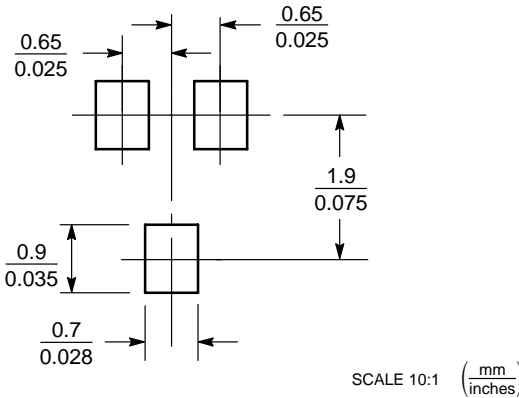

*For additional information on our Pb-Free strategy and soldering details, please download the ON Semiconductor Soldering and Mounting Techniques Reference Manual, SOLDERRM/D.

ON Semiconductor and are registered trademarks of Semiconductor Components Industries, LLC (SCILLC). SCILLC reserves the right to make changes without further notice to any products herein. SCILLC makes no warranty, representation or guarantee regarding the suitability of its products for any particular purpose, nor does SCILLC assume any liability arising out of the application or use of any product or circuit, and specifically disclaims any and all liability, including without limitation special, consequential or incidental damages. "Typical" parameters which may be provided in SCILLC data sheets and/or specifications can and do vary in different applications and actual performance may vary over time. All operating parameters, including "Typicals" must be validated for each customer application by customer's technical experts. SCILLC does not convey any license under its patent rights nor the rights of others. SCILLC products are not designed, intended, or authorized for use as components in systems intended for surgical implant into the body, or other applications intended to support or sustain life, or for any other application in which the failure of the SCILLC product could create a situation where personal injury or death may occur. Should Buyer purchase or use SCILLC products for any such unintended or unauthorized application, Buyer shall indemnify and hold SCILLC and its officers, employees, subsidiaries, affiliates, and distributors harmless against all claims, costs, damages, and expenses, and reasonable attorney fees arising out of, directly or indirectly, any claim of personal injury or death associated with such unintended or unauthorized use, even if such claim alleges that SCILLC was negligent regarding the design or manufacture of the part. SCILLC is an Equal Opportunity/Affirmative Action Employer. This literature is subject to all applicable copyright laws and is not for resale in any manner.

PUBLICATION ORDERING INFORMATION

LITERATURE FULFILLMENT:
Literature Distribution Center for ON Semiconductor
P.O. Box 5163, Denver, Colorado 80217 USA
Phone: 303-675-2175 or 800-344-3860 Toll Free USA/Canada
Fax: 303-675-2176 or 800-344-3867 Toll Free USA/Canada
Email: orderlit@onsemi.com

N. American Technical Support: 800-282-9855 Toll Free USA/Canada

Japan: ON Semiconductor, Japan Customer Focus Center
2-9-1 Kamimeguro, Meguro-ku, Tokyo, Japan 153-0051
Phone: 81-3-5773-3850

ON Semiconductor Website: <http://onsemi.com>

Order Literature: <http://www.onsemi.com/litorder>

For additional information, please contact your local Sales Representative.

MMBT3904WT1/D