

MP6P6C R

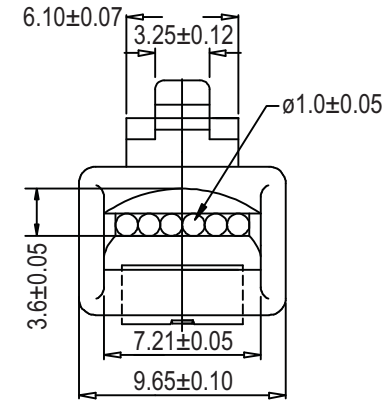
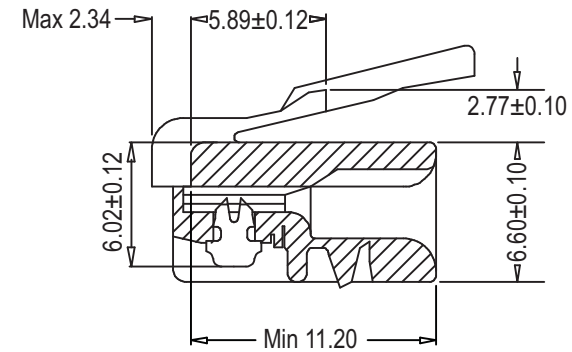
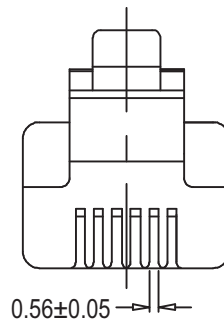

Material:

- Housing: Polycarbonate UL94V2
- Contact Blade: High Strength Copper Alloy
- 100 Micron Nickel underplated
- Plating type: 8% Phosphor Bronze
- Plating Thickness: 6μ" Gold plated
- Operating Temperature: -40°C ~ 125°C

Electrical:

- Current Rating: 250V AC / Max @2.0A
- Dielectric: 500V AC
- Insulation Resistance: 500MΩ

Complies with FCC68/F

Unit: MM



ITEM NO.	A-MO-6/6-SR-R
TITLE	Modular Cable Plug - 6P6C, Round cable, Unshielded

ASSMANN
Electronics, Inc.

1840 W. Drake Drive, Suite 101 • Tempe, AZ 85283
Toll Free: 1-877-277-6266 • Email: info@usa-assmann.com

THIS DRAWING IS UNPUBLISHED
©Copyright 2011 by Assmann Electronic Components
All International Rights Reserved