

HiPerFET™ Power MOSFETs Q-Class

IXFH 20N60Q
IXFT 20N60Q

$V_{DSS} = 600 \text{ V}$
 $I_{D25} = 20 \text{ A}$
 $R_{DS(on)} = 0.35 \text{ } \Omega$

$t_{rr} \leq 250\text{ns}$

N-Channel Enhancement Mode
Avalanche Rated, High dv/dt ,
Low Gate Charge and Capacitances

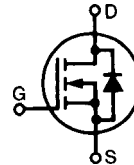

Symbol	Test Conditions	Maximum Ratings	
V_{DSS}	$T_J = 25^\circ\text{C}$ to 150°C	600	V
V_{DGR}	$T_J = 25^\circ\text{C}$ to 150°C ; $R_{GS} = 1 \text{ M}\Omega$	600	V
V_{GS}	Continuous	± 30	V
V_{GSM}	Transient	± 40	V
I_{D25}	$T_C = 25^\circ\text{C}$	20	A
I_{DM}	$T_C = 25^\circ\text{C}$, pulse width limited by T_{JM}	80	A
I_{AR}	$T_C = 25^\circ\text{C}$	20	A
E_{AR}	$T_C = 25^\circ\text{C}$	30	mJ
E_{AS}	$T_C = 25^\circ\text{C}$	1.5	J
dv/dt	$I_S \leq I_{DM}$, $di/dt \leq 100 \text{ A}/\mu\text{s}$, $V_{DD} \leq V_{DSS}$, $T_J \leq 150^\circ\text{C}$, $R_G = 2 \text{ } \Omega$	15	V/ns
P_D	$T_C = 25^\circ\text{C}$	300	W
T_J		-55 ... +150	$^\circ\text{C}$
T_{JM}		150	$^\circ\text{C}$
T_{stg}		-55 ... +150	$^\circ\text{C}$
T_L	1.6 mm (0.062 in.) from case for 10 s	300	$^\circ\text{C}$
M_d	Mounting torque	1.13/10	Nm/lb.in.
Weight	TO-247 AD	6	g
	TO-268	4	g

TO-247 AD (IXFH)

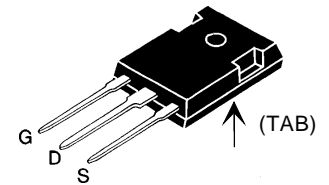

TO-268 (IXFT) Case Style



G = Gate
S = Source
D = Drain
TAB = Drain

Features

- IXYS advanced low gate charge process
- International standard packages
- Low gate charge and capacitance
 - easier to drive
 - faster switching
- Low $R_{DS(on)}$
- Unclamped Inductive Switching (UIS) rated
- Molding epoxies meet UL 94 V-0 flammability classification

Advantages

- Easy to mount
- Space savings
- High power density

Symbol	Test Conditions ($T_J = 25^\circ\text{C}$, unless otherwise specified)	Characteristic Values		
		Min.	Typ.	Max.
V_{DSS}	$V_{GS} = 0 \text{ V}$, $I_D = 250 \text{ } \mu\text{A}$	600		V
$V_{GS(th)}$	$V_{DS} = V_{GS}$, $I_D = 4 \text{ mA}$	2.0		V
I_{GSS}	$V_{GS} = \pm 30 \text{ V}_{DC}$, $V_{DS} = 0$			$\pm 100 \text{ nA}$
I_{DSS}	$V_{DS} = V_{DSS}$, $T_J = 25^\circ\text{C}$			25 μA
	$V_{GS} = 0 \text{ V}$, $T_J = 125^\circ\text{C}$			1 mA
$R_{DS(on)}$	$V_{GS} = 10 \text{ V}$, $I_D = 0.5 I_{D25}$ Pulse test, $t \leq 300 \text{ } \mu\text{s}$, duty cycle $d \leq 2 \%$			0.35 Ω

Symbol	Test Conditions	Characteristic Values		
		(T _J = 25°C, unless otherwise specified)		
		Min.	Typ.	Max.
g_{fs}	V _{DS} = 10 V; I _D = 0.5 I _{D25} , pulse test	10	20	S
C_{iss}	V _{GS} = 0 V, V _{DS} = 25 V, f = 1 MHz		3300	pF
C_{oss}			410	pF
C_{rss}			130	pF
t_{d(on)}	V _{GS} = 10 V, V _{DS} = 0.5 V _{DSS} , I _D = 0.5 I _{D25} R _G = 1.5 Ω (External)		20	ns
t_r			20	ns
t_{d(off)}			45	ns
t_f			20	ns
Q_{g(on)}	V _{GS} = 10 V, V _{DS} = 0.5 V _{DSS} , I _D = 0.5 I _{D25}		90	nC
Q_{gs}			20	nC
Q_{gd}			45	nC
R_{thJC}			0.42	KW
R_{thCK}	(TO-247)		0.25	KW

Symbol	Test Conditions	Characteristic Values		
		(T _J = 25°C, unless otherwise specified)		
		min.	typ.	max.
I_S	V _{GS} = 0 V			20 A
I_{SM}	Repetitive; pulse width limited by T _{JM}			80 A
V_{SD}	I _F = I _S , V _{GS} = 0 V, Pulse test, t ≤ 300 μs, duty cycle d ≤ 2 %			1.5 V
t_{rr}	I _F = I _S , -di/dt = 100 A/μs, V _R = 100 V		0.85	250 ns
Q_{RM}				8 μC
I_{RM}				

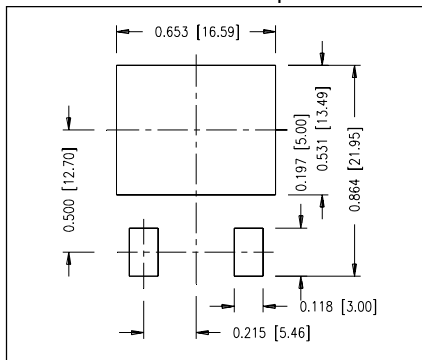
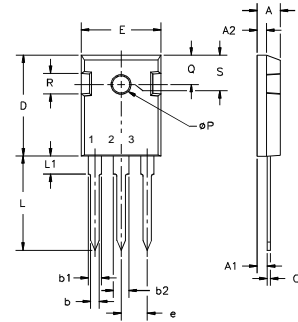
Min Recommended Footprint

TO-247 AD Outline

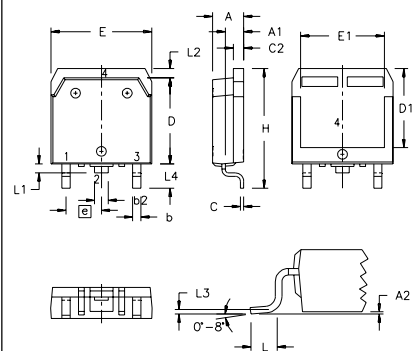
 Terminals: 1 - Gate 2 - Drain
 3 - Source Tab - Drain

Dim.	Millimeter		Inches	
	Min.	Max.	Min.	Max.
A	4.7	5.3	.185	.209
A ₁	2.2	2.54	.087	.102
A ₂	2.2	2.6	.059	.098
b	1.0	1.4	.040	.055
b ₁	1.65	2.13	.065	.084
b ₂	2.87	3.12	.113	.123
C	.4	.8	.016	.031
D	20.80	21.46	.819	.845
E	15.75	16.26	.610	.640
e	5.20	5.72	0.205	0.225
L	19.81	20.32	.780	.800
L ₁		4.50		.177
∅P	3.55	3.65	.140	.144
Q	5.89	6.40	0.232	0.252
R	4.32	5.49	.170	.216
S	6.15	BSC	242	BSC

TO-268 Outline

SYM	INCHES		MILLIMETERS	
	MIN	MAX	MIN	MAX
A	.193	.201	4.90	5.10
A ₁	.106	.114	2.70	2.90
A ₂	.001	.010	0.02	0.25
b	.045	.057	1.15	1.45
b ₂	.075	.083	1.90	2.10
C	.016	.026	0.40	0.65
C ₂	.057	.063	1.45	1.60
D	.543	.551	13.80	14.00
D ₁	.488	.500	12.40	12.70
E	.624	.632	15.85	16.05
E ₁	.524	.535	13.30	13.60
e	.215 BSC		5.45 BSC	
H	.736	.752	18.70	19.10
L	.094	.106	2.40	2.70
L ₁	.047	.055	1.20	1.40
L ₂	.039	.045	1.00	1.15
L ₃	.010 BSC		0.25 BSC	
L ₄	.150	.161	3.80	4.10

IXYS reserves the right to change limits, test conditions, and dimensions.

IXYS MOSFETs and IGBTs are covered by one or more of the following U.S. patents:

 4,835,592 4,881,106 5,017,508 5,049,961 5,187,117 5,486,715 6,306,728B1 6,259,123B1 6,306,728B1
 4,850,072 4,931,844 5,034,796 5,063,307 5,237,481 5,381,025 6,404,065B1 6,162,665 6,534,343

Fig. 1. Output Characteristics
@ 25 Deg. C

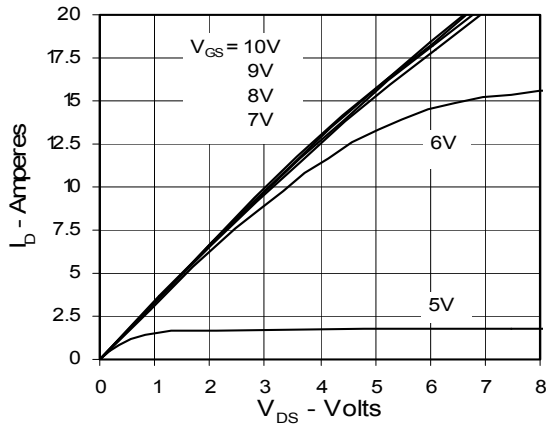

Fig. 2. Extended Output Characteristics
@ 25 deg. C

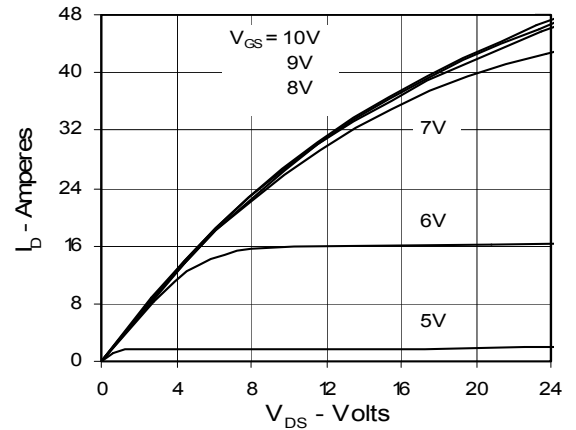

Fig. 3. Output Characteristics
@ 125 Deg. C

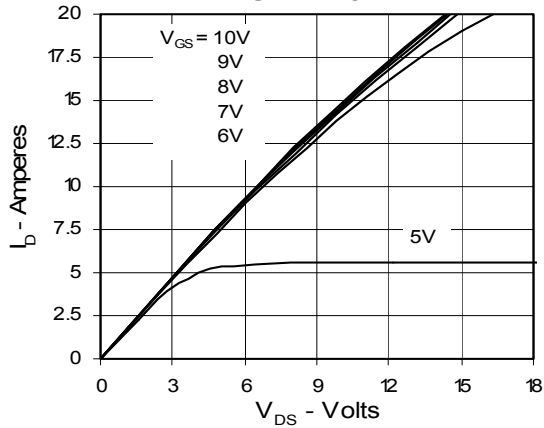

Fig. 4. $R_{DS(on)}$ Normalized to I_{D25} Value vs. Junction Temperature

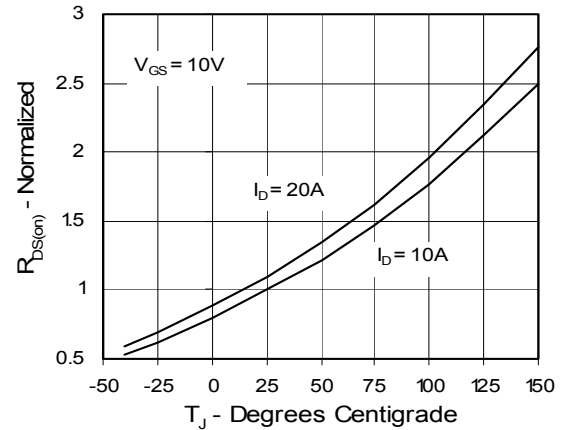

Fig. 5. $R_{DS(on)}$ Normalized to I_{D25} Value vs. I_D

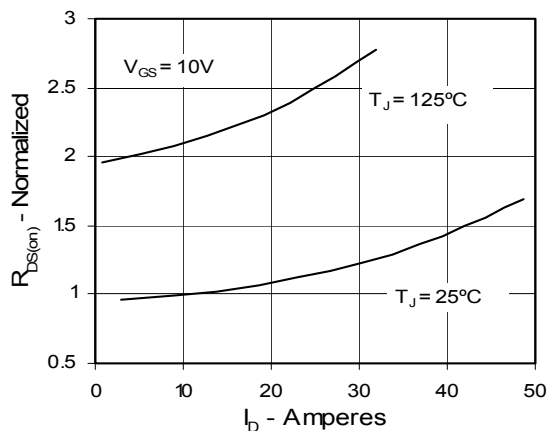

Fig. 6. Drain Current vs. Case Temperature

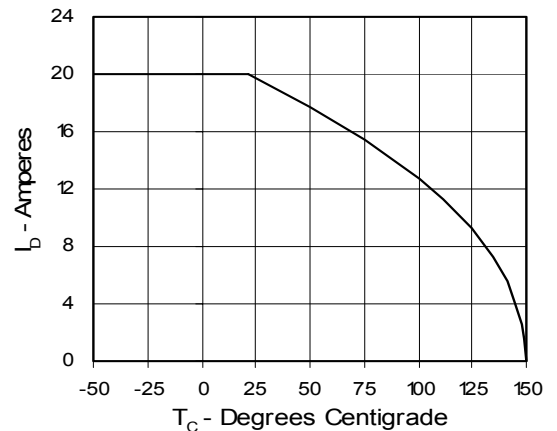

Fig. 7. Input Admittance

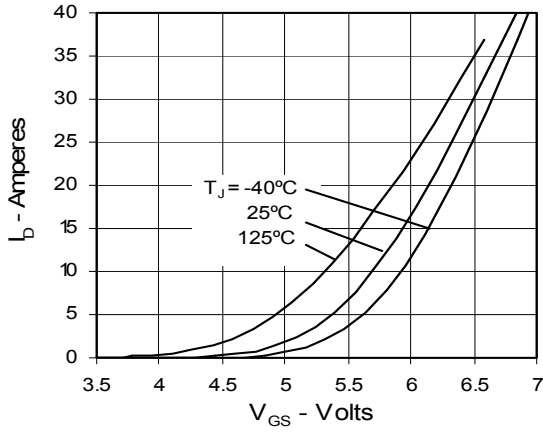

Fig. 8. Transconductance

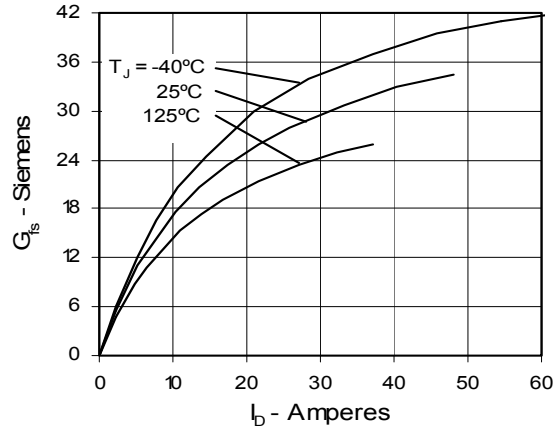

Fig. 9. Source Current vs. Source-To-Drain Voltage

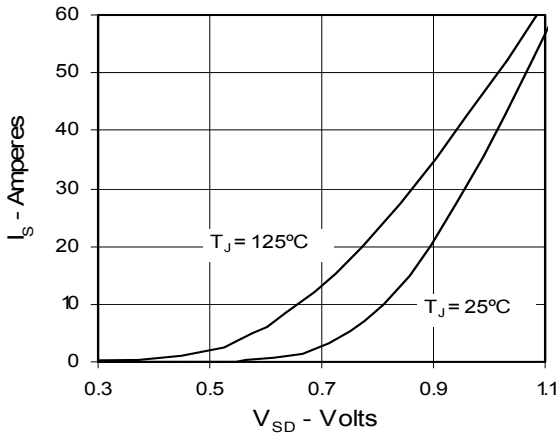

Fig. 10. Gate Charge

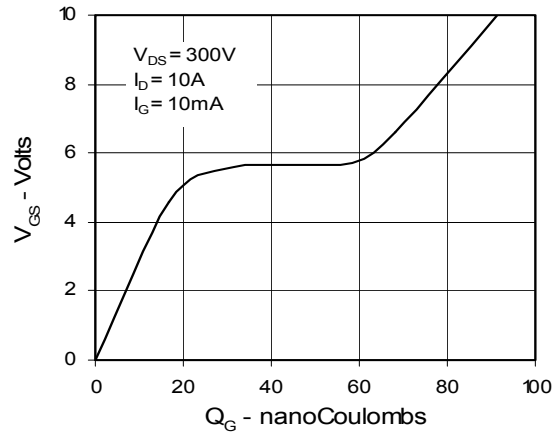

Fig. 11. Capacitance

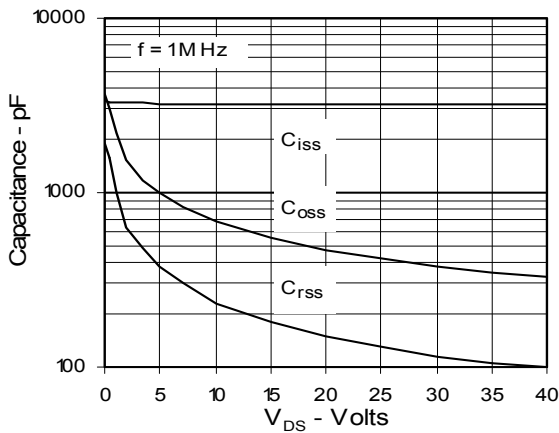
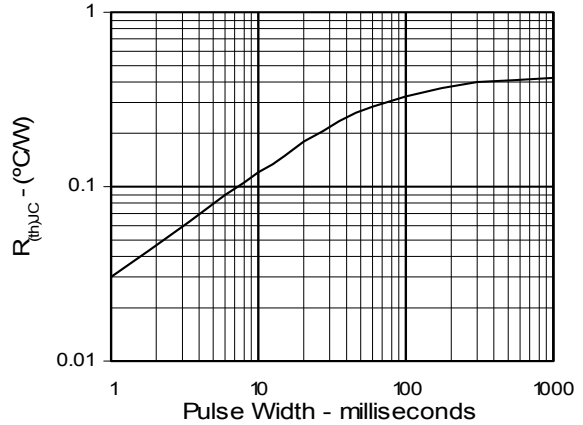

Fig. 12. Maximum Transient Thermal Resistance



IXYS reserves the right to change limits, test conditions, and dimensions.

IXYS MOSFETs and IGBTs are covered by one or more of the following U.S. patents:

4,835,592 4,881,106 5,017,508 5,049,961 5,187,117 5,486,715 6,306,728B1 6,259,123B1 6,306,728B1
4,850,072 4,931,844 5,034,796 5,063,307 5,237,481 5,381,025 6,404,065B1 6,162,665 6,534,343