



ILH100

Hermetic Phototransistor Optocoupler

FEATURES

- Operating Temperature Range, -55°C to $+125^{\circ}\text{C}$
- Current Transfer Ratio Guaranteed from -55°C to $+100^{\circ}\text{C}$ Ambient Temperature Range
- High Current Transfer Ratio at Low Input Current
- Isolation Test Voltage, 3000 V_{DC}
- Base Lead Available for Transistor Biasing
- Standard 8 Pin DIP Package

DESCRIPTION

The ILH100 is designed especially for hi-rel applications requiring optical isolation with high current transfer ratio and low saturation V_{CE} . Each optocoupler consists of a light emitting diode and a NPN silicon phototransistor mounted and coupled in an 8 pin hermetically sealed DIP package. The ILH100's low input current makes it well suited for direct CMOS to LSTTL/TTL interfaces.

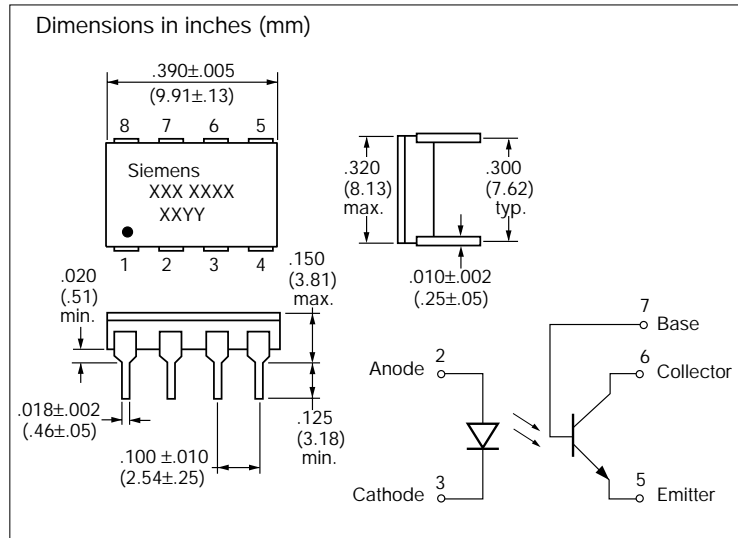

Maximum Ratings

Emitter

Reverse Voltage.....	6.0 V
Forward Current.....	60 mA
Peak Forward Current ⁽¹⁾	1.0 A
Power Dissipation.....	150 mW
Derate Linearly from 25°C.....	1.5 mW/°C

Detector

Collector-Emitter Voltage.....	70 V
Emitter-Base Voltage.....	7.0 V
Collector-Base Voltage.....	70 V
Continuous Collector Current.....	50 mA
Power Dissipation.....	300 mW
Derate Linearly from 25°C.....	3.0 mW/°C

Package

Input-Output Isolation Test Voltage ⁽²⁾	3000 VDC
Storage Temperature Range.....	-65°C to $+150^{\circ}\text{C}$
Operating Temperature Range.....	-55°C to $+125^{\circ}\text{C}$
Junction Temperature.....	150°C
Soldering Time at 240°C, 1.6 mm from case.....	10 sec.
Power Dissipation.....	350 mW
Derate Linearly from 25°C.....	3.5 mW/°C

Notes:

1. Values applies for $P_W \leq 1.0$ ms, $PRR \leq 300$ pps.
2. Measured between pins 1,2,3 and 4 shorted together and pins 5,6,7 and 8 shorted together. $T_A = 25^{\circ}\text{C}$ and duration=1.0 second, RH=45%.

Characteristics $T_A=25^\circ\text{C}$, unless otherwise specified

Parameter	Symbol	Min.	Typ.	Max.	Unit	Condition
Emitter						
Forward Voltage	V_F	—	1.45	1.7	V	$I_F=60\text{ mA}$
Reverse Breakdown Voltage	V_{BR}	6.0	—	—		$I_R=10\text{ }\mu\text{A}$
Reverse Current	I_R	—	0.01	10	μA	$V_R=6.0\text{ V}$
Capacitance	C_J		20	—	pF	$V_F=0\text{ V}$, $f=1.0\text{ MHz}$
Thermal Resistance	R_{TH}		220		$^\circ\text{C/W}$	Junction to Lead
Detector						
Collector-Emitter Saturation Voltage	$V_{CE(sat)}$	—	0.25	0.4	V	$I_B=20\mu\text{A}$, $I_{CE}=1.0\text{ mA}$
Base-Emitter Voltage	V_{BE}		0.65	—		$I_B=20\mu\text{A}$
Collector-Emitter Leakage Current	I_{CEO}		5.0	50	nA	$V_{CE}=10\text{ V}$
DC Forward Current Gain	HFE	250	400	750	—	$V_{CE}=10\text{ V}$, $I_B=20\text{ }\mu\text{A}$
Saturated DC Forward Gain	$HFE_{(sat)}$	125	200	325	—	$V_{CE}=0.4\text{ V}$, $I_B=20\text{ }\mu\text{A}$
Capacitance	C_{CE}	—	6.8	—	pF	$V_{CE}=5.0\text{ V}$, $f=1.0\text{ MHz}$
	C_{CB}		8.5			
	C_{EB}		11			
Thermal Resistance	R_{TH}	—	220	—	$^\circ\text{C/W}$	Junction to Lead
Coupled Characteristics (-55°C to 100°C)						
Saturated Current Transfer Ratio	$CTR_{(sat)}$	70	210	250	%	$I_F=10\text{ mA}$, $V_{CE}=0.4\text{ V}$
Current Transfer Ratio, Collector-Emitter	CTE_{ce}	100	300	450	%	$I_F=10\text{ mA}$, $V_{CE}=10\text{ V}$
Current Transfer Ratio, Collector-Base	CTR_{cb}	0.4	0.7	0.9		$I_F=10\text{ mA}$, $V_{CB}=9.3\text{ V}$
Isolation and Insulation						
Common Mode Rejection Output High	CM_H	1000	2000	—	V/ μs	$V_{CM}=500\text{ V}_{p-p}$, $V_{CC}=5.0\text{ V}$, $R_L=1.0\text{ K}\Omega$, $I_F=0\text{ mA}$
Common Mode Rejection Output Low	CM_L	1000	2000	—	V/ μs	$V_{CM}=500\text{ V}_{p-p}$, $V_{CC}=5.0\text{ V}$, $R_L=1.0\text{ K}\Omega$, $I_F=10\text{ mA}$
Package Capacitance	C_{IO}	—	1.5	—	pF	$V_{IO}=0\text{ V}$, 1.0 MHz
Insulation Resistance	R_{IO}	10^{11}	10^{14}	—	W	$V_{IO}=500\text{ VDC}$
Leakage Current, Input-Output	I_{IO}	—	—	10	μA	Relative Humidity $\leq 50\%$, $V_{IO} 3000\text{ VDC}$, 5.0 sec.

Typical Switching Speeds $T_A=25^\circ\text{C}$

Non-Saturated Switching	Symbol	Typ.	Max.	Unit	Test Condition
Delay	t_d	0.8	2.0	μs	—
Rise	t_r	2.0	5.0		$V_{CC}=5.0\text{ V}$
Storage	t_s	0.4	1.5		$R_L=75\text{ }\Omega$
Fall	t_f	2.0	5.0		$I_F=10\text{ mA}$
Propagation-High to Low	t_{pHL}	1.0	3.0		50% of V_{pp}
Propagation-Low to High	t_{pLH}	1.5	4.0		$R_{BE}=\text{open}$
Saturated Switching⁽¹⁾	Symbol	Typ.	Max.		
Delay	t_d	0.7	2.0	$V_{CE}=0.4\text{ V}$	
Rise	t_r	1.0	3.0	$V_{CE}=0.4\text{ V}$	
Storage	t_s	13.5	30	$R_L=1.0\text{ K}\Omega$	
Fall	t_f	12		$I_F=10\text{ mA}$	
Propagation-High to Low	t_{pHL}	1.4	5.0	$V_{CC}=5.0\text{ V}$ $V_{TH}=1.5\text{ V}$	
Propagation-Low to High	t_{pLH}	15	40	$R_{BE}=\text{open}$	

Figure 1. Switching time waveform and test schematic—non-saturated test condition

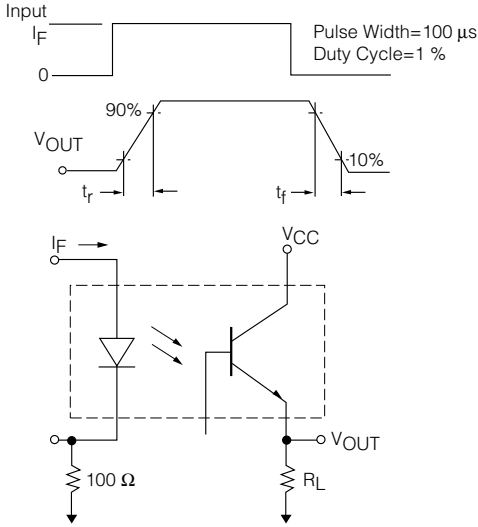

Figure 2. Forward current versus forward voltage and temperature

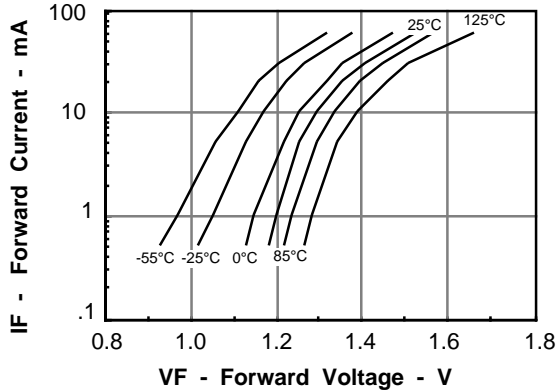

Figure 3. Peak LED current versus duty factor refresh rate and temperature

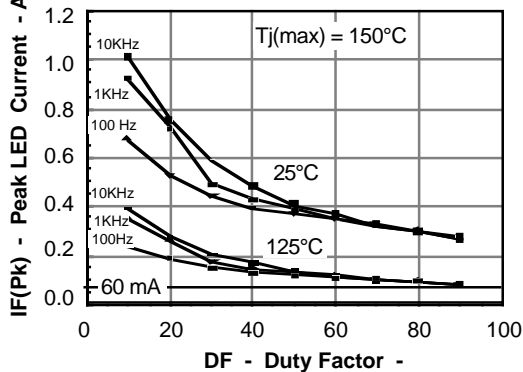

Figure 4. Normalized non-saturated current transfer ratio versus temperature and LED current

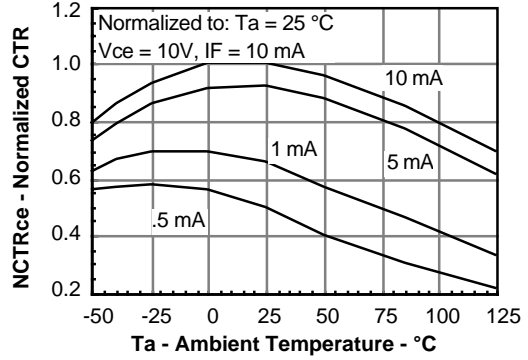

Figure 5. Normalized saturated current transfer ratio versus temperature and LED current

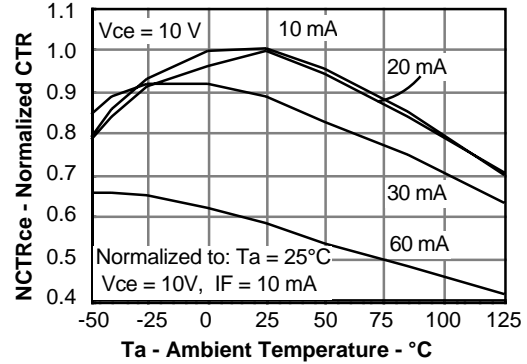

Figure 6. Normalized saturated current transfer ratio versus temperature and LED current

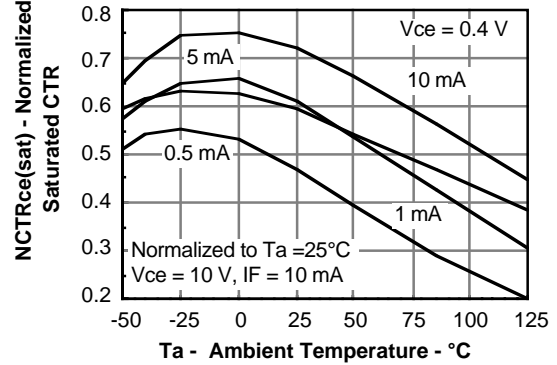

Figure 7. Collector-emitter current versus temperature and LED current

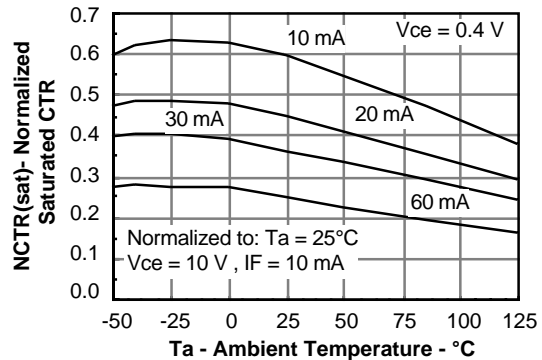

Figure 8. Collector-emitter current versus temperature and LED current

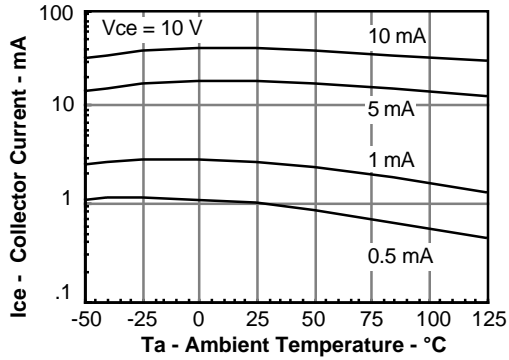

Figure 9. Collector-emitter current versus temperature and LED current

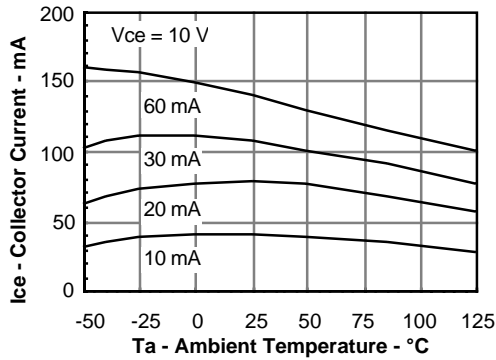

Figure 10. Saturated collector-emitter current versus temperature and LED current

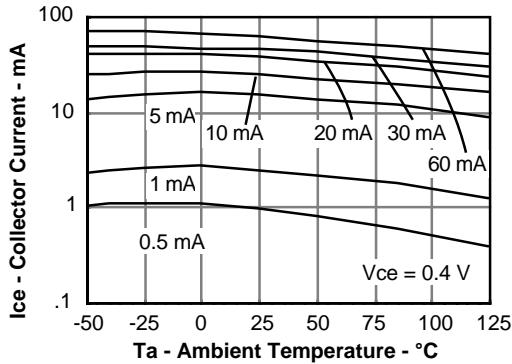

Figure 11. Saturated collector-emitter current versus temperature and LED current

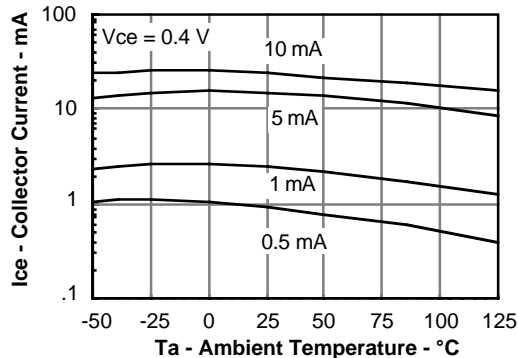

Figure 12. Normalized collector base CRT versus temperature and LED current

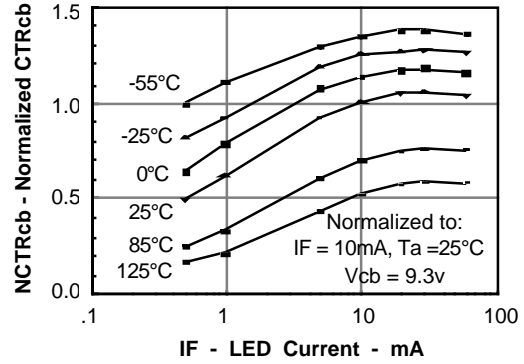

Figure 13. Normalized I_{cb} photocurrent versus temperature and LED current

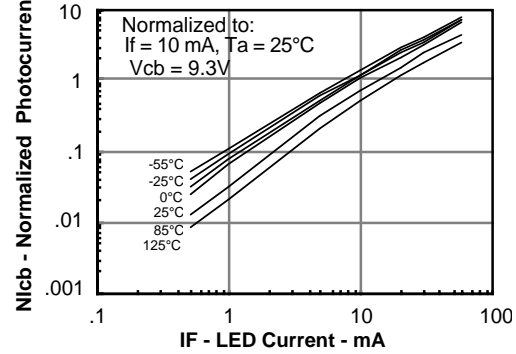

Figure 14. Normalized non-saturated and saturated HFE at $T_A=25^\circ\text{C}$ versus base current

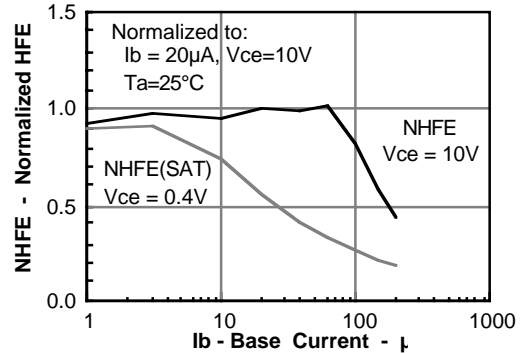

Figure 15. Normalized non-saturated and saturated HFE at $T_A=50^\circ\text{C}$ versus base current

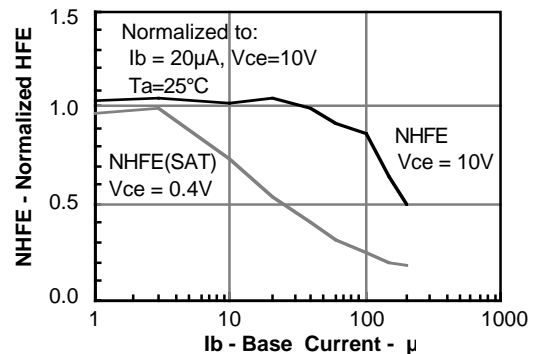

Figure 16. Normalized non-saturated and saturated HFE at $T_A=70^\circ\text{C}$ versus base current

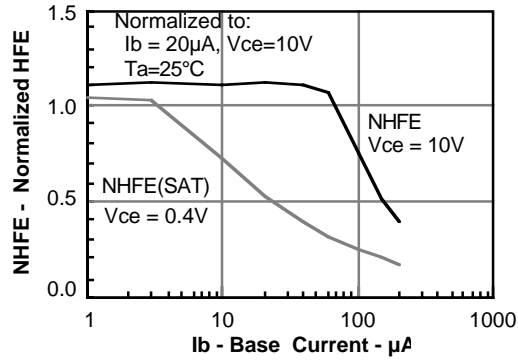

Figure 17. Collector-emitter leakage current versus temperature

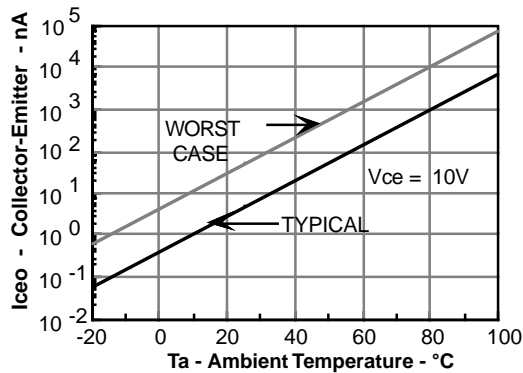

Figure 18. Base emitter voltage versus base current

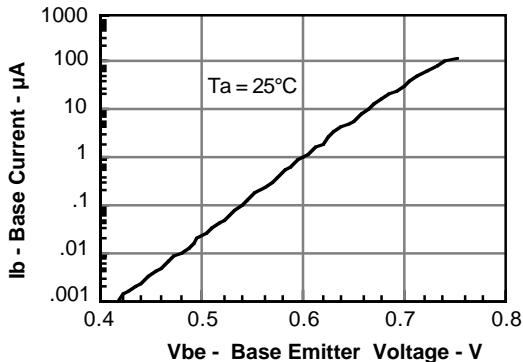

Figure 19. Base emitter capacitance versus base emitter voltage

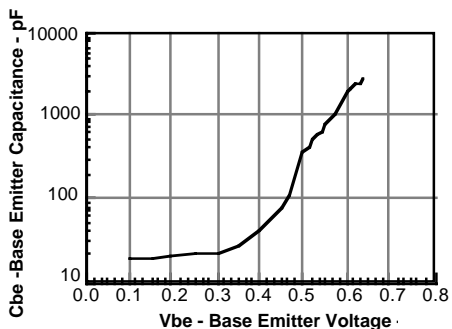

Figure 20. Propagation delay versus temperature and collector load resistance for $I_F=5.0\text{ mA}$

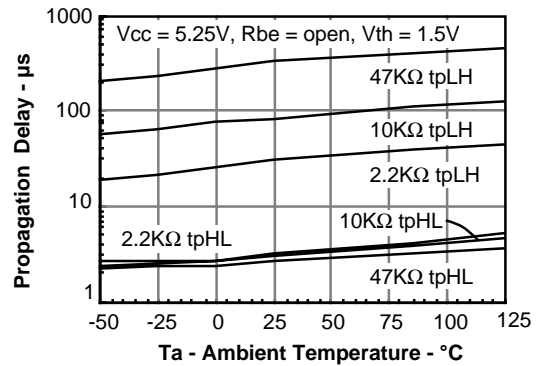

Figure 21. Propagation delay versus temperature and collector load resistance for $I_F=10\text{ mA}$

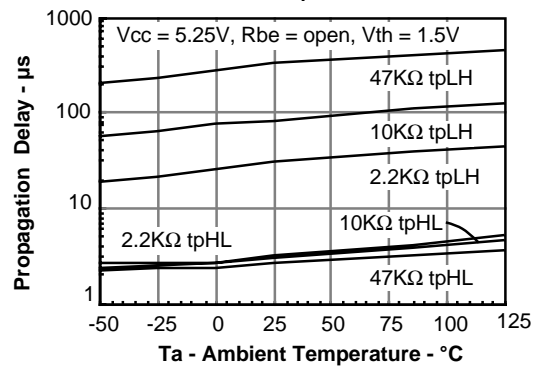

Figure 22. Propagation delay versus temperature and collector load resistance for $I_F=20\text{ mA}$

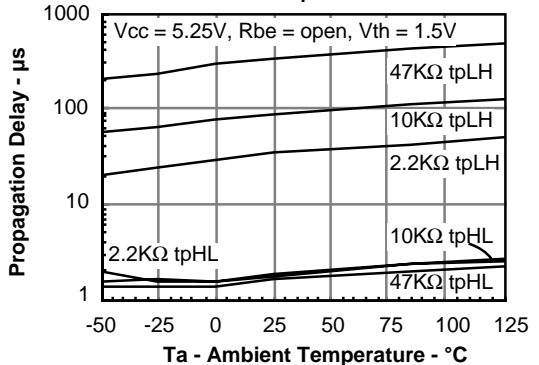

Figure 23. Propagation delay versus temperature and collector load resistance for $I_F=5.0\text{ mA}$

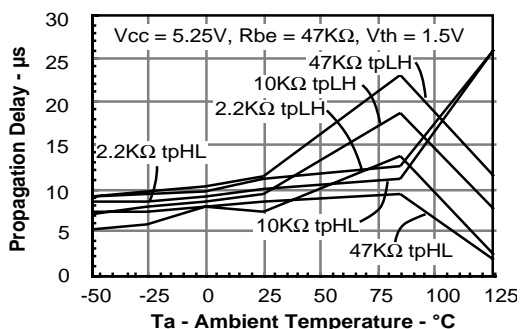

Figure 1. Switching time waveform and test schematic—saturated test condition

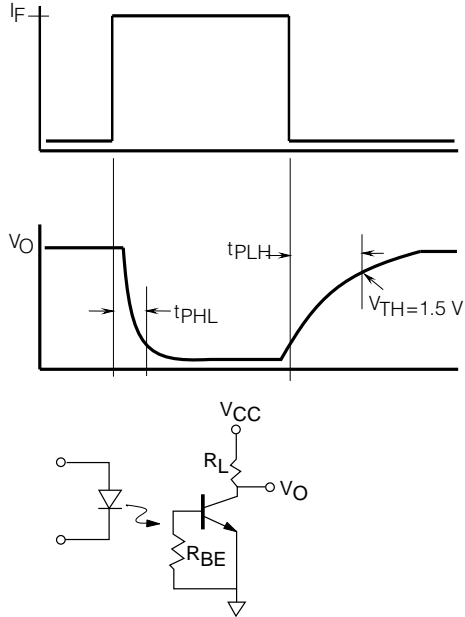

Figure 2. Propagation delay versus temperature and collector load resistance for $I_F=10$ mA

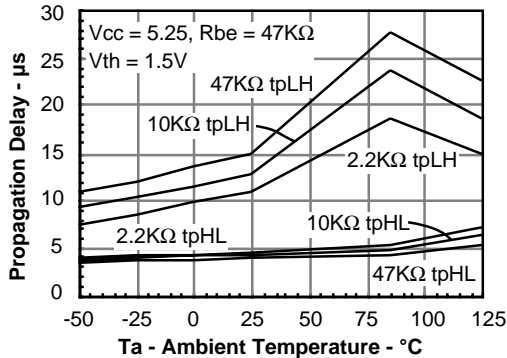

Figure 3. Propagation delay versus temperature and collector load resistance for $I_F=20$ mA

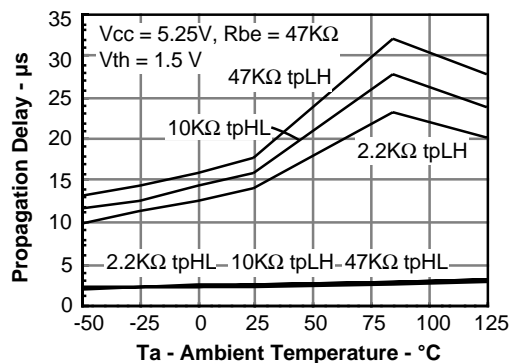

Figure 4. Propagation delay versus collector load and base-emitter resistance for $I_F=5.0$ mA

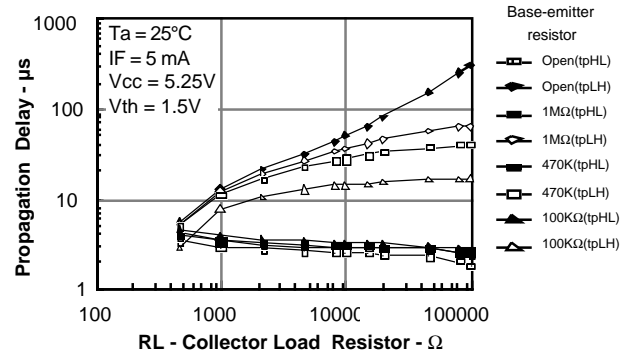

Figure 5. Propagation delay versus collector load and base-emitter resistance for $I_F=5.0$ mA

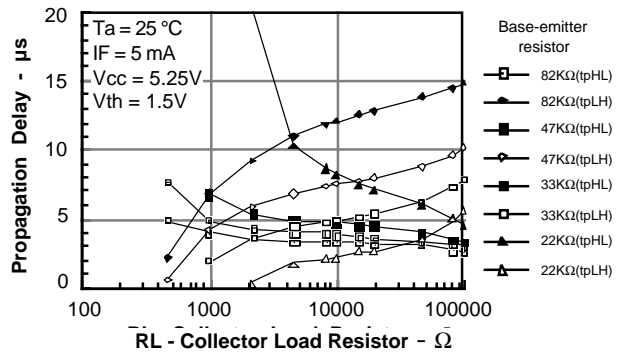

Figure 6. Propagation delay versus collector load and base-emitter resistance for $I_F=10$ mA

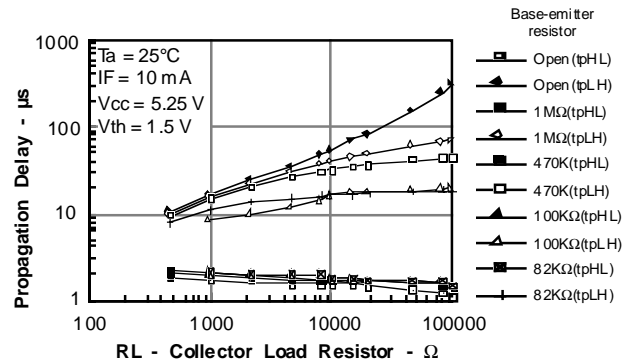

Figure 7. Propagation delay versus collector load and base-emitter resistance for $I_F=10$ mA

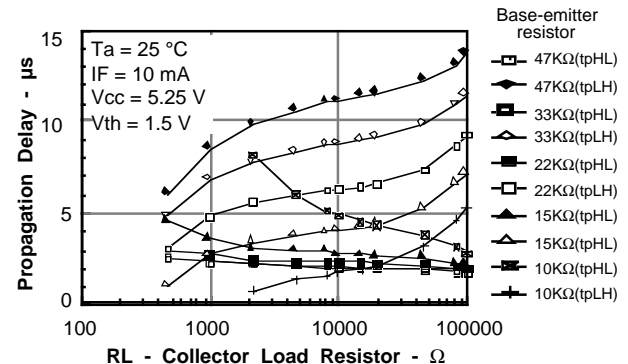

Figure 8. Propagation delay versus collector load and base-emitter resistance for $I_F=15\text{ mA}$

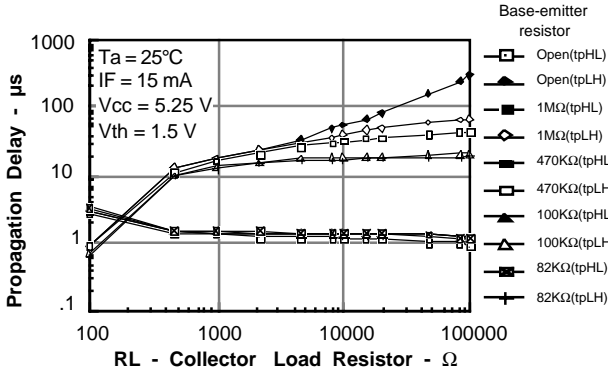

Figure 11. Propagation delay versus collector load and base-emitter resistance for $I_F=15\text{ mA}$

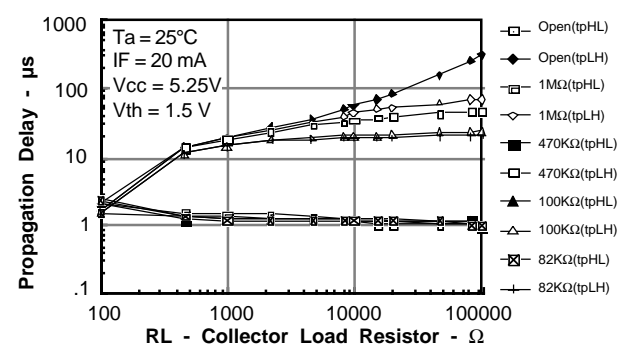

Figure 9. Propagation delay versus collector load and base-emitter resistance for $I_F=15\text{ mA}$

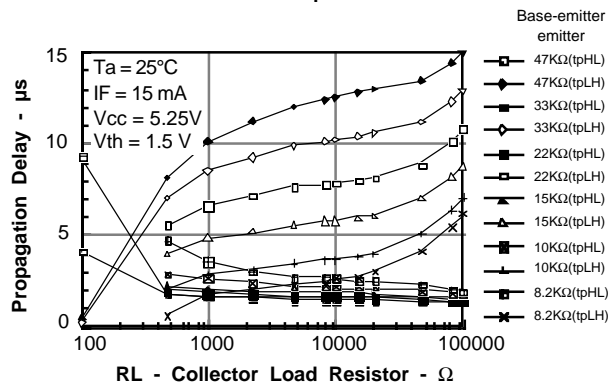

Figure 12. Common mode transient rejection

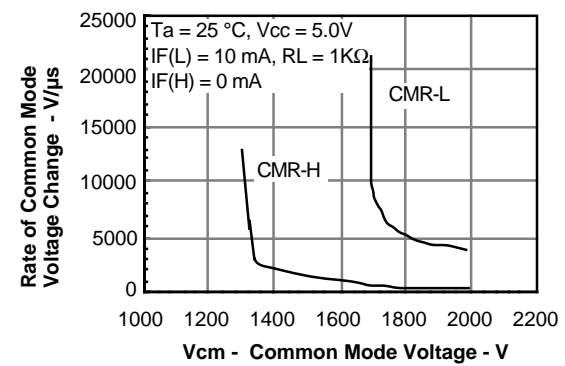

Figure 10. Propagation delay versus collector load and base-emitter resistance for $I_F=15\text{ mA}$

