

Silicon diffused power transistor

BU2520A

GENERAL DESCRIPTION

New generation, high-voltage, high-speed switching npn transistor in a plastic envelope intended for use in horizontal deflection circuits of large screen colour television receivers up to 32 kHz.

QUICK REFERENCE DATA

SYMBOL	PARAMETER	CONDITIONS	TYP.	MAX.	UNIT
V_{CESM}	Collector-emitter voltage peak value	$V_{BE} = 0$ V	-	1500	V
V_{CEO}	Collector-emitter voltage (open base)		-	800	V
I_C	Collector current (DC)		-	10	A
I_{CM}	Collector current peak value		-	25	A
P_{tot}	Total power dissipation	$T_{mb} \leq 25$ °C	-	125	W
V_{CEsat}	Collector-emitter saturation voltage	$I_C = 6.0$ A; $I_B = 1.2$ A	-	5.0	V
I_{Csat}	Collector saturation current		6	-	A
t_f	Fall time	$I_{CM} = 6.0$ A; $I_{B(on)} = 0.85$ A	0.2	-	μ s

PINNING - SOT93

PIN	DESCRIPTION
1	base
2	collector
3	emitter
tab	collector

PIN CONFIGURATION

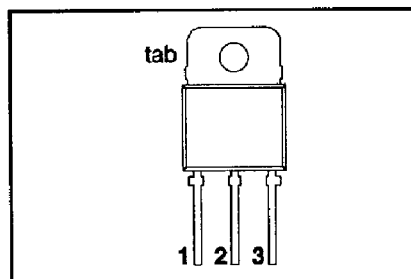

SYMBOL

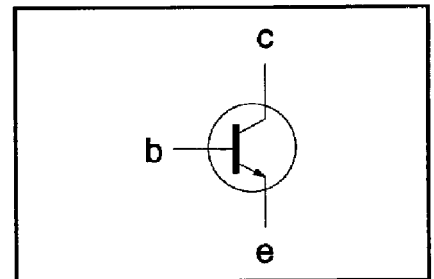

LIMITING VALUES

Limiting values in accordance with the Absolute Maximum Rating System (IEC 134)

SYMBOL	PARAMETER	CONDITIONS	MIN.	MAX.	UNIT
V_{CESM}	Collector-emitter voltage peak value	$V_{BE} = 0$ V	-	1500	V
V_{CEO}	Collector-emitter voltage (open base)		-	800	V
I_C	Collector current (DC)		-	10	A
I_{CM}	Collector current peak value		-	25	A
I_B	Base current (DC)		-	6	A
I_{BM}	Base current peak value		-	9	A
$-I_{B(AV)}$	Reverse base current	average over any 20 ms period	-	150	mA
$-I_{BM}$	Reverse base current peak value ¹		-	6	A
P_{tot}	Total power dissipation	$T_{mb} \leq 25$ °C	-	125	W
T_{stg}	Storage temperature		-65	150	°C
T_j	Junction temperature		-	150	°C

THERMAL RESISTANCES

SYMBOL	PARAMETER	CONDITIONS	TYP.	MAX.	UNIT
$R_{th(j-mb)}$	Junction to mounting base	-	-	1.0	K/W
$R_{th(j-a)}$	Junction to ambient	in free air	45	-	K/W

¹ Turn-off current.

7110826 0077585 907

July 1994

180

Rev 1.100

Silicon diffused power transistor

BU2520A

STATIC CHARACTERISTICS

$T_{mb} = 25\text{ }^\circ\text{C}$ unless otherwise specified

SYMBOL	PARAMETER	CONDITIONS	MIN.	TYP.	MAX.	UNIT
I_{CES}	Collector cut-off current ²	$V_{BE} = 0\text{ V}; V_{CE} = V_{CESMmax}$	-	-	1.0	mA
I_{CES}		$V_{BE} = 0\text{ V}; V_{CE} = V_{CESMmax}$	-	-	2.0	mA
I_{EBO}	Emitter cut-off current	$T_j = 125\text{ }^\circ\text{C}$ $V_{EB} = 7.5\text{ V}; I_C = 0\text{ A}$	-	-	1.0	mA
$V_{CEOsust}$	Collector-emitter sustaining voltage	$I_B = 0\text{ A}; I_C = 100\text{ mA};$ $L = 25\text{ mH}$	800	-	-	V
V_{CEsat}	Collector-emitter saturation voltage	$I_C = 6.0\text{ A}; I_B = 1.2\text{ A}$	-	-	5.0	V
V_{BEsat}	Base-emitter saturation voltage	$I_C = 6.0\text{ A}; I_B = 1.2\text{ A}$	-	-	1.3	V
h_{FE}	DC current gain	$I_C = 100\text{ mA}; V_{CE} = 5\text{ V}$	6	13	26	
h_{FE}		$I_C = 6\text{ A}; V_{CE} = 5\text{ V}$	5	7	10	

DYNAMIC CHARACTERISTICS

$T_{mb} = 25\text{ }^\circ\text{C}$ unless otherwise specified

SYMBOL	PARAMETER	CONDITIONS	TYP.	MAX.	UNIT
C_c	Collector capacitance	$I_E = 0\text{ A}; V_{CB} = 10\text{ V}; f = 1\text{ MHz}$	115	-	pF
	Switching times (32 kHz line deflection circuit)	$I_{CM} = 6.0\text{ A}; L_C = 330\text{ }\mu\text{H}; C_{fb} = 9\text{ nF};$ $I_{B(end)} = 0.85\text{ A}; L_B = 3.45\text{ }\mu\text{H};$ $-V_{BB} = 4\text{ V}; (-di_B/dt = 1.2\text{ A}/\mu\text{s})$			
t_s	Turn-off storage time		3.0	4.0	μs
t_f	Turn-off fall time		0.2	0.35	μs
	Switching times (16 kHz line deflection circuit)	$I_{CM} = 6.0\text{ A}; L_C = 650\text{ }\mu\text{H}; C_{fb} = 19\text{ nF};$ $I_{B(end)} = 1.0\text{ A}; L_B = 5.3\text{ }\mu\text{H}; -V_{BB} = 4\text{ V};$ $(-di_B/dt = 0.8\text{ A}/\mu\text{s})$			
t_s	Turn-off storage time		4.5	5.5	μs
t_f	Turn-off fall time		0.35	0.5	μs

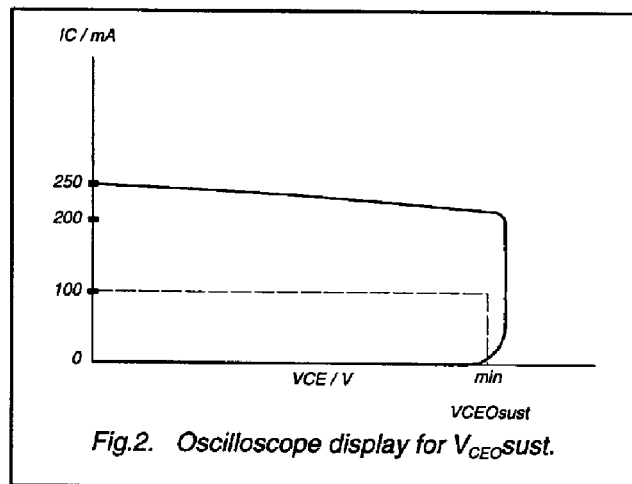
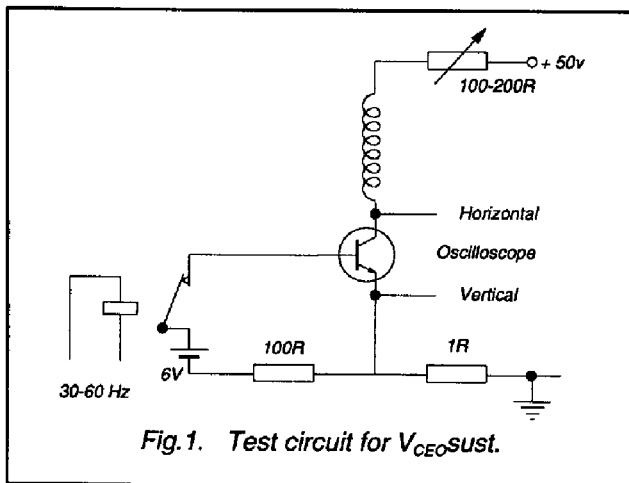

² Measured with half sine-wave voltage (curve tracer).

7110826 0077586 843
July 1994

Silicon diffused power transistor

BU2520A

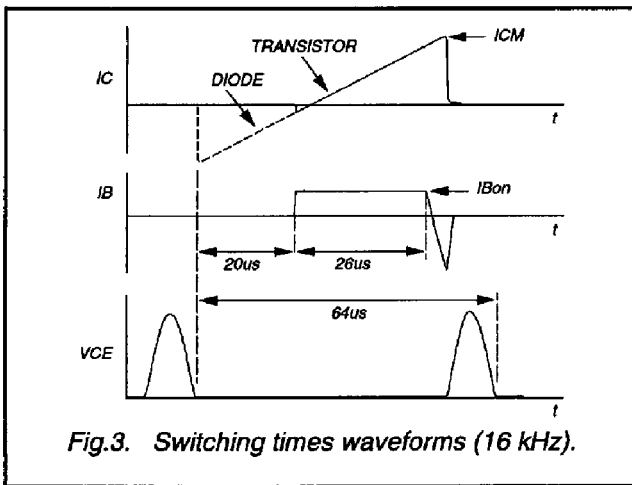

Fig.3. Switching times waveforms (16 kHz).

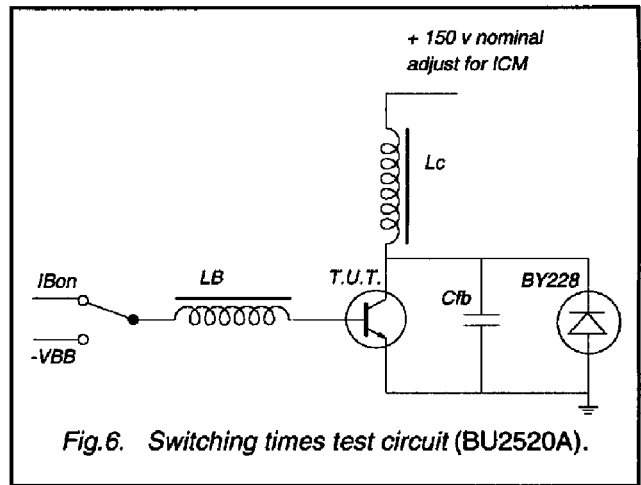

Fig.6. Switching times test circuit (BU2520A).

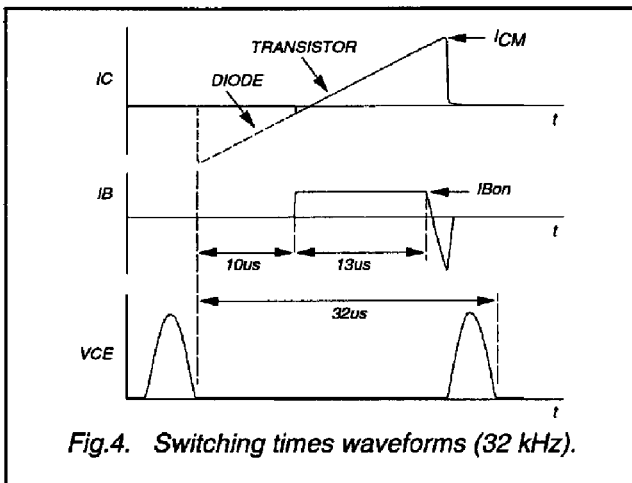

Fig.4. Switching times waveforms (32 kHz).

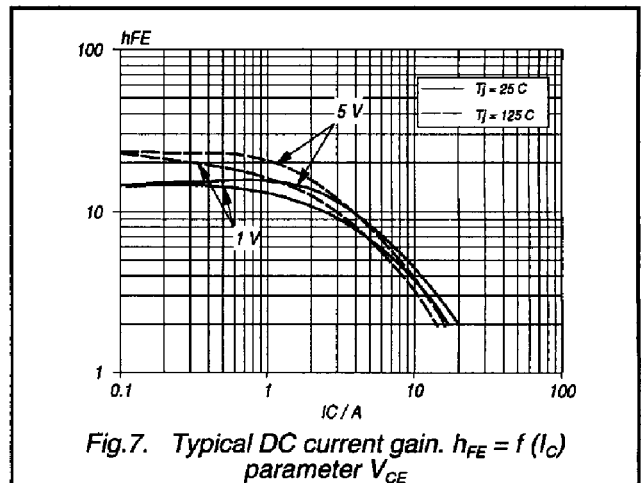

Fig.7. Typical DC current gain. $h_{FE} = f(I_C)$ parameter V_{CE}

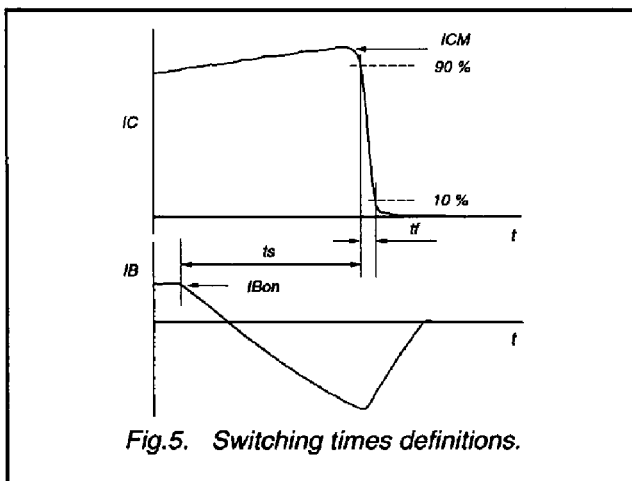

Fig.5. Switching times definitions.

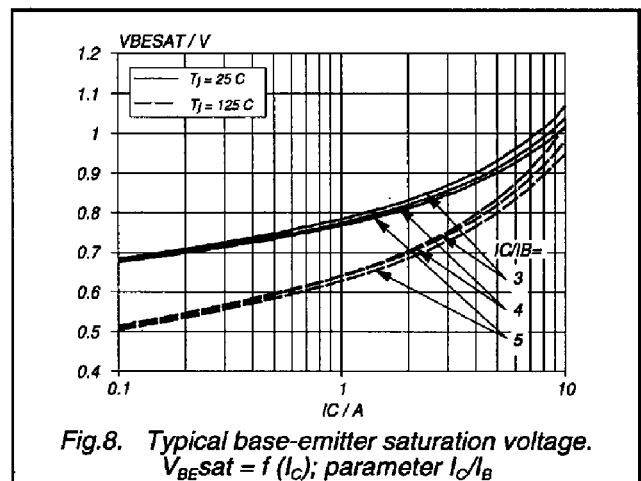
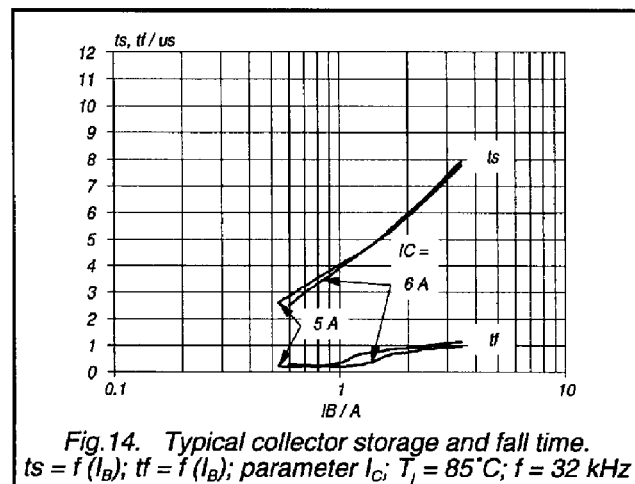
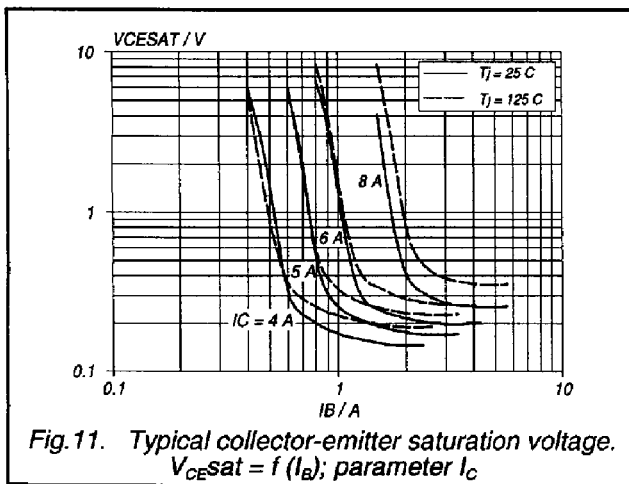
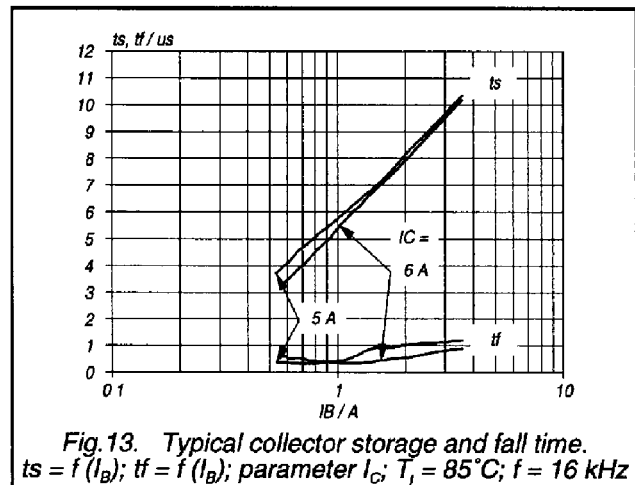
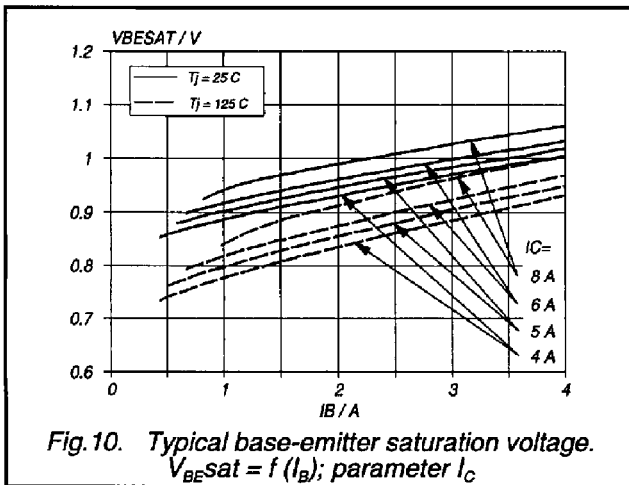
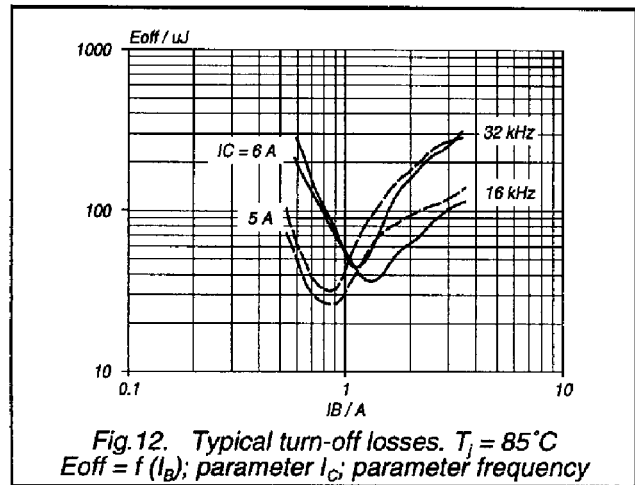
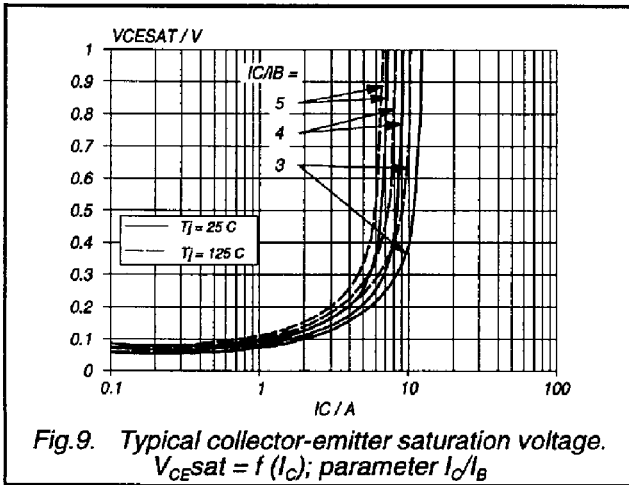

Fig.8. Typical base-emitter saturation voltage. $V_{BEsat} = f(I_C)$; parameter I_C/I_B

Silicon diffused power transistor

BU2520A



7110826 0077588 616

July 1994

183

Rev 1.100

Silicon diffused power transistor

BU2520A

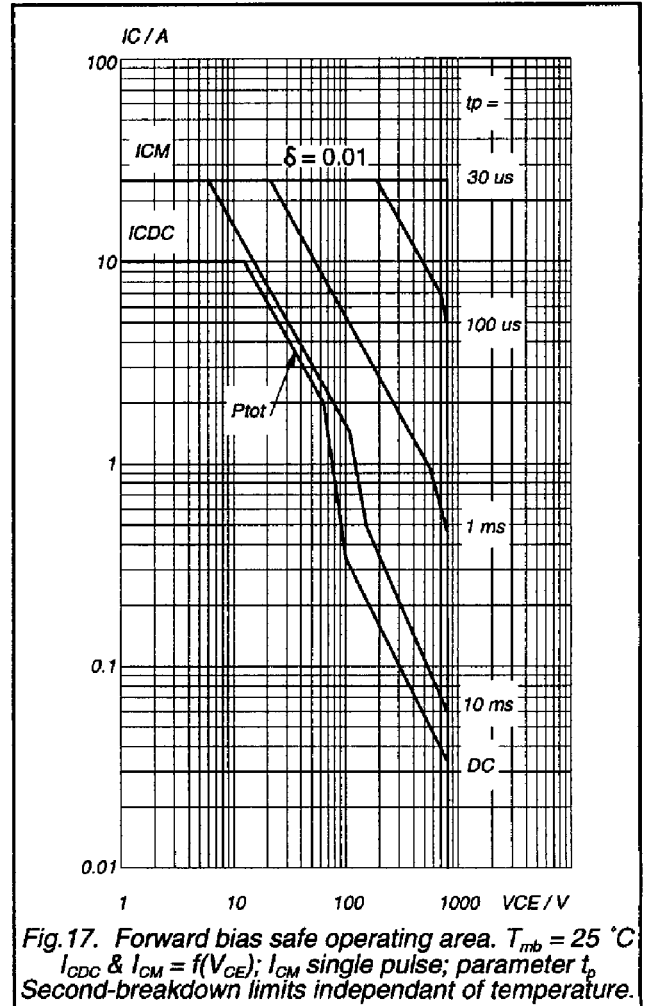
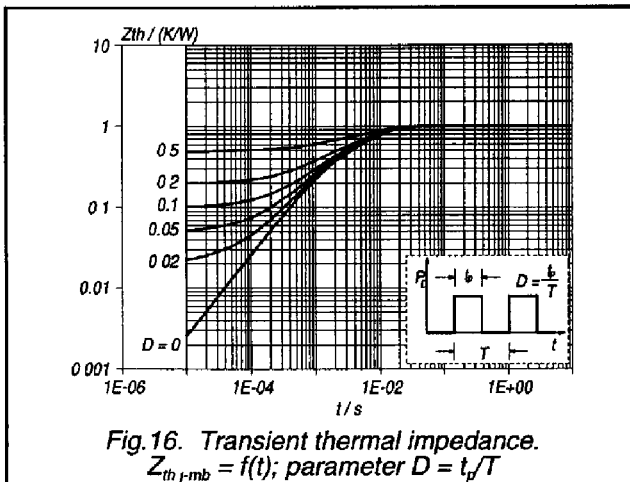
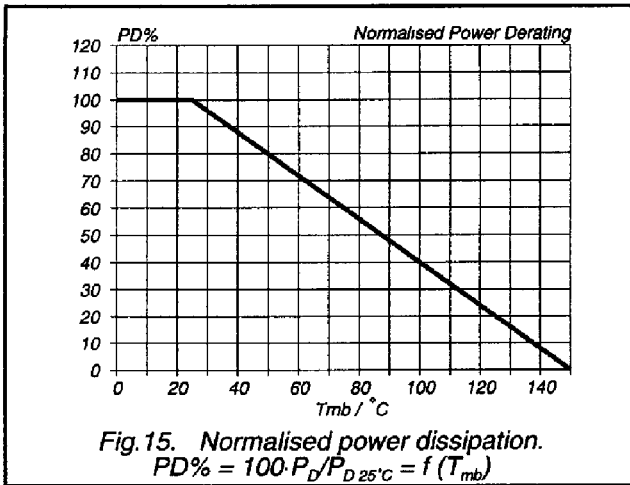

7110826 0077589 552

July 1994

184

Rev 1.100

Silicon diffused power transistor

BU2520A

MECHANICAL DATA

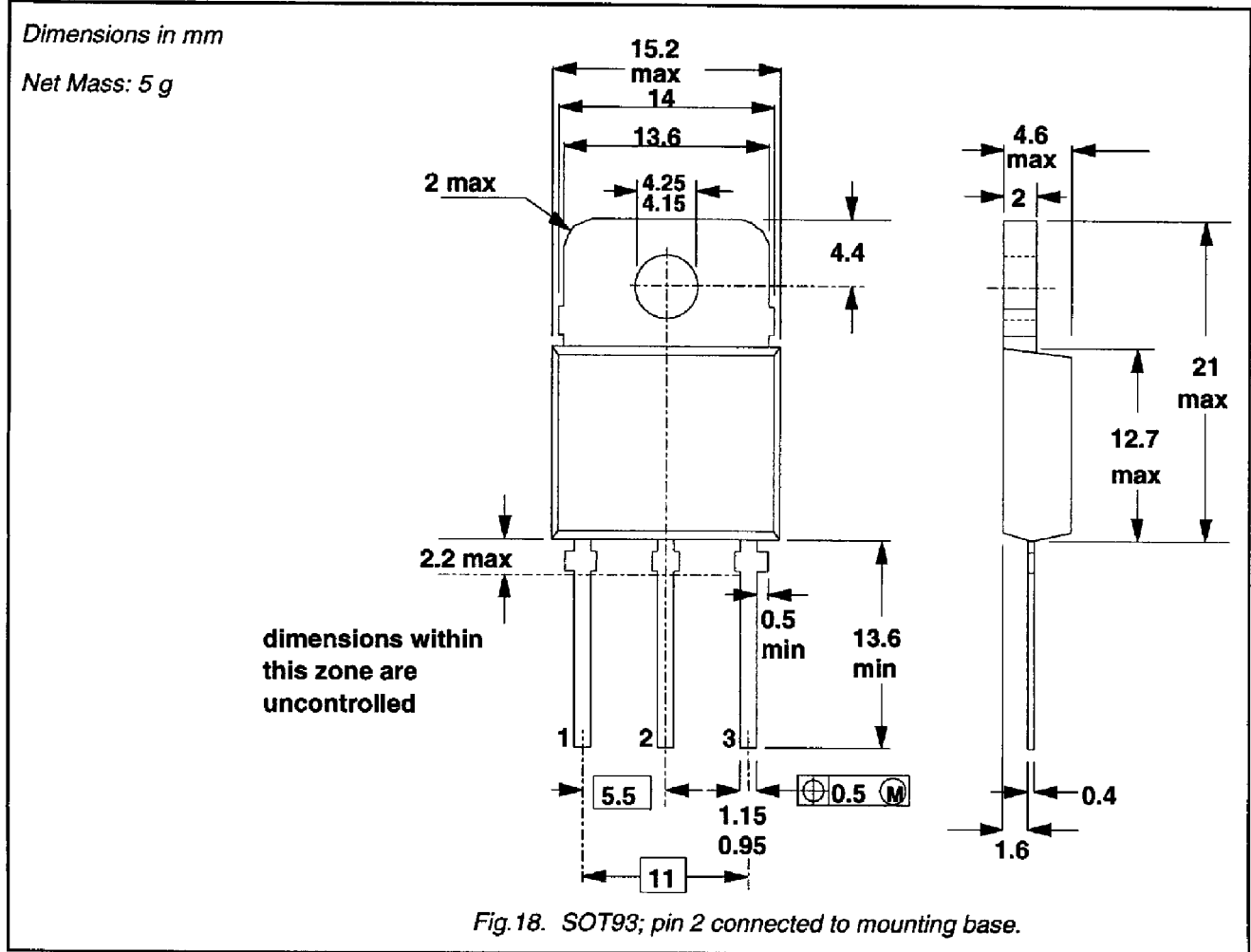

Notes

- Accessories supplied on request: refer to mounting instructions for SOT93 envelope.

7110826 0077590 274

July 1994

185

Rev 1.100