



Frontier Electronics Corp.

667 E. COCHRAN STREET, SIMI VALLEY, CA 93065

TEL: (805) 522-9998 FAX: (805) 522-9989

E-mail: frontiersales@frontierusa.com

Web: <http://www.frontierusa.com>

1A ULTRA FAST RECOVERY RECTIFIER

FUF4001 THRU FUF4007

FEATURES

- PLASTIC PACKAGE HAS UNDERWRITERS LABORATORY FLAMMABILITY CLASSIFICATION 94V-0
- ULTRA FAST RECOVERY TIMES FOR HIGH EFFICIENCY
- LOW FORWARD VOLTAGE, HIGH CURRENT CAPABILITY
- LOW LEAKAGE
- HIGH SURGE CAPABILITY
- HIGH TEMPERATURE SOLDERING GUARANTEED:
260°C 0.375" (9.5mm) LEAD LENGTHS FOR 10 SECONDS AT 5 LBS.(2.3KG)TENSION

MECHANICAL DATA

- CASE: MOLDED PLASTIC, DO41, DIMENSIONS IN INCHES AND (MILLIMETERS)
- TERMINALS: AXIAL LEADS SOLDERABLE PER MIL-STD-202, METHOD 208
- POLARITY: COLOR BAND DENOTES CATHODE END
- MOUNTING POSITION: ANY
- WEIGHT: 0.34 GRAMS

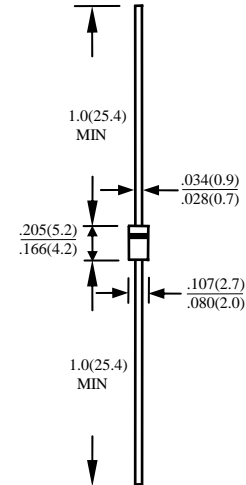

MAXIMUM RATINGS AND ELECTRICAL CHARACTERISTICS RATINGS AT 25°C AMBIENT TEMPERATURE UNLESS OTHERWISE SPECIFIED SINGLE PHASE, HALF WAVE, 60 HZ, RESISTIVE OR INDUCTIVE LOAD. FOR CAPACITIVE LOAD, DERATE CURRENT BY 20%

RATINGS	SYMBOL	FUF4001	FUF4002	FUF4003	FUF4004	FUF4005	FUF4006	FUF4007	UNITS
MAXIMUM RECURRENT PEAK REVERSE VOLTAGE	V_{RRM}	50	100	200	400	600	800	1000	V
MAXIMUM RMS VOLTAGE	V_{RMS}	35	70	140	280	420	560	700	V
MAXIMUM DC BLOCKING VOLTAGE	V_{DC}	50	100	200	400	600	800	1000	V
MAXIMUM AVERAGE FORWARD RECTIFIED CURRENT 0.375"(9.5mm) LEAD LENGTH AT TA=55°C	I_O	1.0							A
PEAK FORWARD SURGE CURRENT, 8.3ms SINGLE HALF SINE-WAVE SUPERIMPOSED ON RATED LOAD	I_{FSM}	30							A
TYPICAL JUNCTION CAPACITANCE (NOTE 1)	C_J	20				15			PF
TYPICAL THERMAL RESISTANCE (NOTE 2)	$R_{\theta ja}$	50							°C/W
STORAGE TEMPERATURE RANGE	T_{STG}	- 55 TO + 150							°C
OPERATING TEMPERATURE RANGE	T_{OP}	- 55 TO + 150							°C

ELECTRICAL CHARACTERISTICS (AT TA=25°C UNLESS OTHERWISE NOTED)

CHARACTERISTICS	SYMBOL	FUF4001	FUF4002	FUF4003	FUF4004	FUF4005	FUF4006	FUF4007	UNITS
MAXIMUM FORWARD VOLTAGE AT I_O DC	V_F	1.3			1.7			V	
MAXIMUM DC REVERSE CURRENT AT TA=25°C	I_R	5							μA
MAXIMUM DC REVERSE CURRENT AT TA=100°C	I_R	50							μA
MAXIMUM REVERSE RECOVERY TIME (NOTE 3)	T_{RR}	50				75			nS

- NOTE: 1. MEASURED AT 1 MHZ AND APPLIED REVERSE VOLTAGE OF 4.0 VOLTS
 2. BOTH LEADS ATTACHED TO HEAT SINK 20x20x1t(mm) COPPER PLATE AT LEAD LENGTH 5mm
 3. REVERSE RECOVERY TEST CONDITIONS: $I_F=0.5A$, $I_R=1.0A$, $I_{RR}=0.25A$

RATINGS AND CHARACTERISTIC CURVE FUF4001 THRU FUF4007

FIG. 1-TEST CIRCUIT DIAGRAM AND REVERSE RECOVERY TIME CHARACTERISTIC

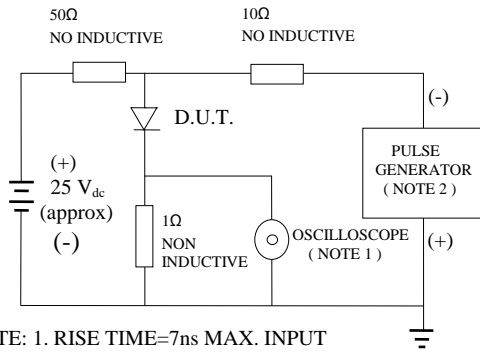

NOTE: 1. RISE TIME=7ns MAX. INPUT IMPEDANCE=1 MOhms 22PF
 2. RISE TIME =10ns MAX. SOURCE IMPEDANCE=50 OHMS

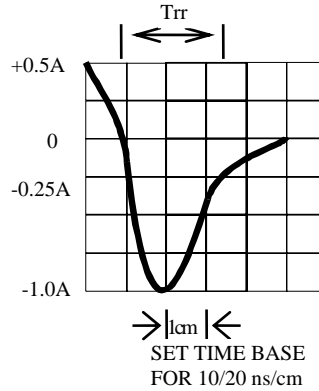

FIG. 2-TYPICAL FORWARD CURRENT DERATING CURVE

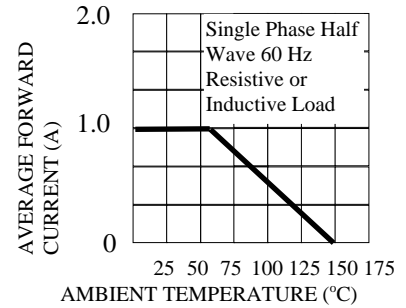

FIG. 3-TYPICAL REVERSE CHARACTERISTICS

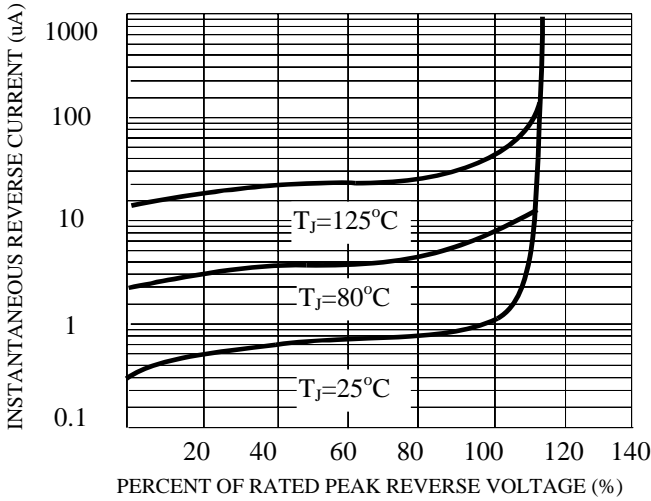

FIG. 4-TYPICAL INSTANTANEOUS FORWARD CHARACTERISTICS

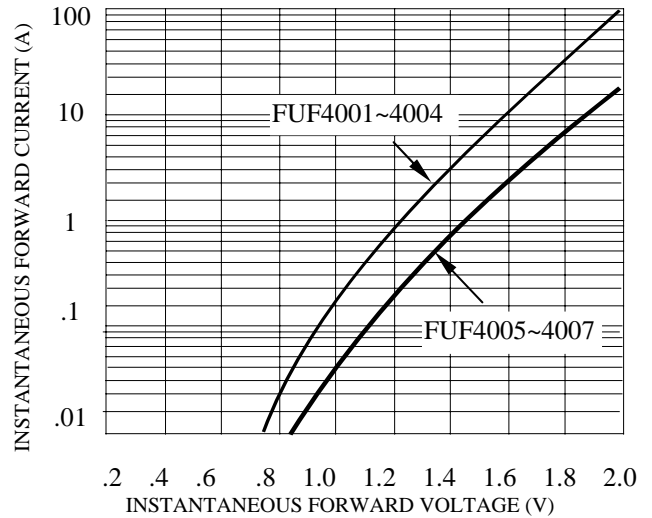

FIG. 5-MAXIMUM NON-REPETITIVE FORWARD SURGE CURRENT

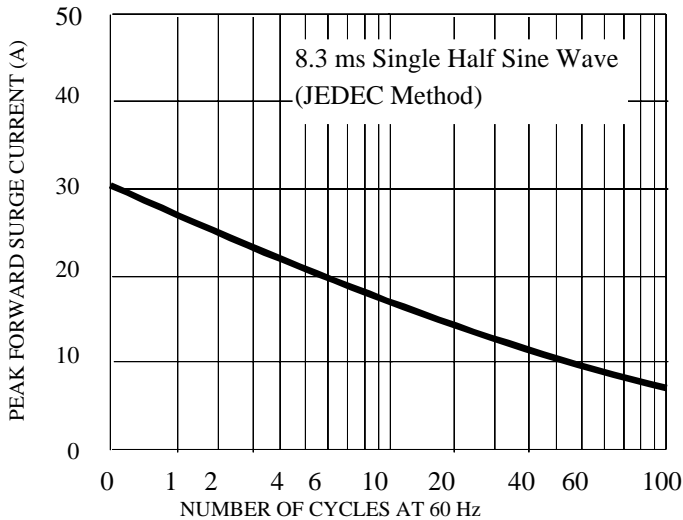

FIG. 6-TYPICAL JUNCTION CAPACITANCE

