

XC9510 Series



Synchronous Step-Down DC/DC Converter with Built-In LDO Regulator In Series Plus Voltage Detector

- ◆ Synchronous Step-Down DC/DC Converter with Built-In LDO Regulator Plus Voltage Detector
- ◆ Step-Down DC/DC Converter's Output Connected In Series with LDO Regulator
- ◆ High Efficiency, Low Noise Regulated Output
- ◆ SOP-8 Package for High Current
- ◆ Small-Footprint
- ◆ Output Current DC/DC: 800mA, VR: 400mA
- ◆ Ceramic Capacitor Compatible (Low ESR capacitors)

GENERAL DESCRIPTION

The XC9510 series consists of a step-down DC/DC converter and a high-speed LDO regulator connected in series with the DC/DC converter's output. A voltage detector is also built-in. A highly efficient, low noise output is possible since the regulator is stepped-down further from the DC/DC output. The DC/DC converter block incorporates a P-channel driver transistor and a synchronous N-channel switching transistor. With an external coil, diode and two capacitors, the XC9510 can deliver output currents up to 800mA at efficiencies over 90%. The XC9510 is designed for use with small ceramic capacitors. A choice of three switching frequencies are available, 300 kHz, 600 kHz, and 1.2 MHz. Output voltage settings for the DC/DC is set-up internally in 100mV steps within the range of 1.6V to 4.0V ($\pm 2.0\%$) and for the VR are set-up internally within the range of 0.9V to 4.0V ($\pm 2.0\%$). For the VD, the range is of 0.9V to 5.0V ($\pm 2.0\%$). The soft start time of the series is internally set to 5ms. With the built-in U.V.L.O. (Under Voltage Lock Out) function, the internal P-channel driver transistor is forced OFF when input voltage becomes 1.4 V or lower. The operational states of the DC/DC and the regulator blocks can be changed by inputting three kinds of voltage level via the CE/MODE pin. The functions of the MODE pin can be selected via the external control pin to switch the DC/DC control mode and the disable pin to shut down the regulator block.

APPLICATIONS

- CD-R / RW, DVD
- HDD
- PDAs, portable communication modem
- Cellular phones
- Palmtop computers
- Cameras, video recorders

FEATURES

- Input Voltage Range** : 2.4V ~ 6.0V
- Low ESR Capacitor** : Ceramic capacitor compatible (Low ESR Capacitors)
- VD Function** : Detects output voltage from the V_{DO}UT pin while sensing either V_{DD}, DC_{OUT}, or VR_{OUT} internally. N-ch open drain output
- <DC/DC Converter Block>**
 - Output Voltage Range** : 1.6V ~ 4.0V (Accuracy $\pm 2\%$)
 - Output Current** : 800mA
 - Controls** : PWM Control, PWM, PWM/PFM Automatic Switching External
 - Oscillation Frequency** : 300kHz, 600kHz, 1.2MHz
- <Regulator Block>**
 - Output Voltage Range** : 0.9V ~ 4.0V (Accuracy $\pm 2\%$)
 - Current Limit** : 600mA
 - Dropout Voltage** : 160mV @ I_{OUT}=200mA (V_{OUT}=2.8V)
 - High Ripple Rejection** : 60dB @ 1kHz (V_{OUT}=2.8V)

TYPICAL APPLICATION CIRCUIT

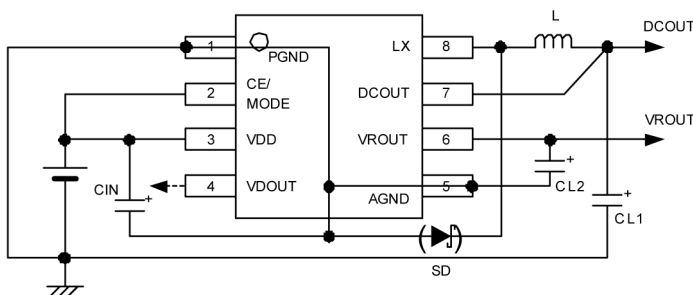

TYPICAL PERFORMANCE CHARACTERISTICS

XC9510Hxxxx
 DC/DC Efficiency (DC_{OUT}: 3.4V, 1.2MHz), VR Efficiency (VR_{OUT}: 3.0V)
 V_{IN}=5.0V, T_{opr}=25°C, L: 4.7 μH (CDRH4D28C)
 C_{IN}: 4.7 μF (ceramic), C_{L1}: 10 μF (ceramic), C_{L2}: 4.7 μF (ceramic)

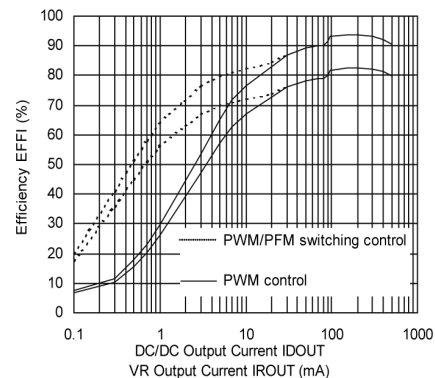

XC9510 Series

PIN CONFIGURATION

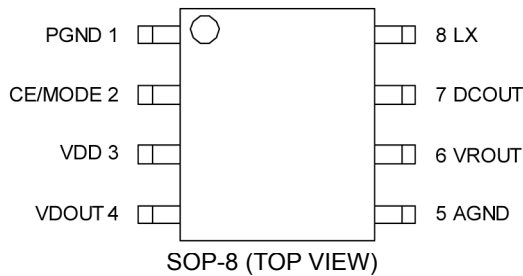

PIN ASSIGNMENT

PIN NUMBER	PIN NAME	FUNCTION
1	PGND	Power Ground
2	CE/MODE	Chip Enable / MODE Switch
3	VDD	Power Supply
4	VDOUT	VD Output
5	AGND	Analog Ground
6	VROUT	VR Output
7	DCOUT	DC/DC Output
8	LX	Switch

PRODUCT CLASSIFICATION

Ordering Information

XC9510①②③④⑤⑥ The input for the voltage regulator block comes from the DC/DC.

DESIGNATOR	DESCRIPTION	SYMBOL	DESCRIPTION
①	Control Methods And The VD Sense Pin	As chart below	: -
②③	Setting Voltage & Specifications	Internal standard	: Setting voltage and specifications of each DC/DC, VR, and VD Based on the internal standard)
④	DC/DC Oscillation Frequency	3	: 300kHz
		6	: 600kHz
		C	: 1.2MHz
⑤	Package	S	: SOP-8
⑥	Device Orientation	R	: Embossed Tape, standard feed
		L	: Embossed Tape, reverse feed

Control Methods, CE/MODE Pin, VDSENSE Pin

SERIES	TYPE	DC/DC CONTROL METHODS	CE="VCEH" LEVEL	CE="VCEM" LEVEL	CE="VCEL" LEVEL	VD SENSE PIN
XC9510	A	PWM Control	-	-	DC/DC: OFF VR: OFF VD: ON	VDD
	B					DCOUT
	C					VROUT
	D					VDD
	E	DCOUT				
	F	VROUT				
	H	PWM, PFM/PWM Manual Switch	PFM / PWM Automatic Switch	PWM Control	DC/DC: OFF VR: OFF VD: ON	VDD
	K					DCOUT
L	VROUT					

■ PACKAGING INFORMATION

● SOP-8

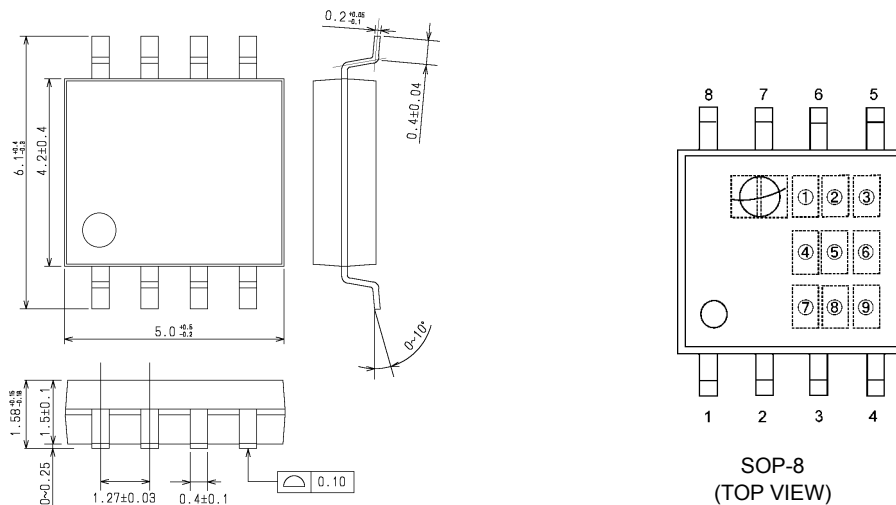

SOP-8
(TOP VIEW)

■ MARKING RULE

● SOP-8

①② Represents product series

MARK		PRODUCT SERIES
①	②	
1	0	XC9510****S*

③ Represents DC/DC control methods, CE/MODE pins and VD sense pin

MARK	DC/DC CONTROL	CE/MODE PIN (H level)	CE/MODE PIN (M level)	CE/MODE PIN (L level)	VD SENSE	PRODUCT SERIES
A	PWM Control	-	-	DC/DC:OFF VR:OFF VD:ON	VDD	XC9510A****S*
B					DCOUT	XC9510B****S*
C					VRout	XC9510C****S*
D					VDD	XC9510D****S*
E					DCOUT	XC9510E****S*
F					VRout	XC9510F****S*
H	PWM,PFM/PWM Manual Switch	PFM/PWM Auto Switch	PWM Control		VDD	XC9510H****S*
K					DCOUT	XC9510K****S*
L					VRout	XC9510L****S*

MARKING RULE (Continued)

④⑤ Represents detect voltage DC/DC, VR and VD

ex)

MARK		DC/DC	VR	VD	PRODUCT SERIES
④	⑤				
1	3	3.3V	1.8V	4.0V	XC9510*13*S*

⑥ Represents oscillation frequency.

MARK	OSCILLATION FREQUENCY	PRODUCT SERIES
3	300kHz	XC9510***3A*
6	600kHz	XC9510***6A*
C	1.2MHz	XC9510***CA*

⑦ Represents last digit of production year.

ex)

MARK	PRODUCTION YEAR
3	2003
4	2004

⑧⑨ Represents production lot number

0 to 9, A to Z reverse character 0 to 9, A to Z repeated (G, I, J, O, Q, W excepted)

Note: No character inversion used

BLOCK DIAGRAM

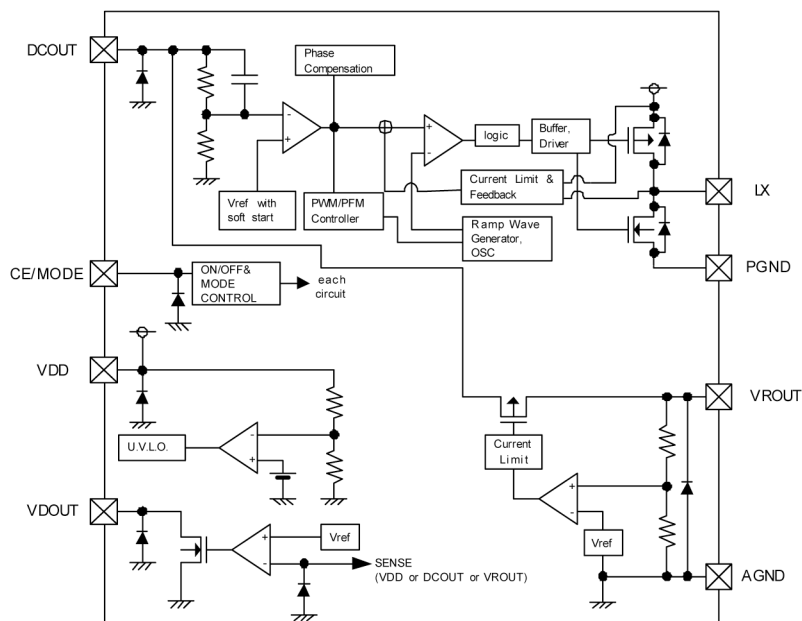

* Diodes shown in the above circuit are protective diodes.

■ ABSOLUTE MAXIMUM RATINGS

Ta = 25°C

PARAMETER		SYMBOL	RATINGS	UNIT
VDD Pin Voltage		VDD	- 0.3 ~ 6.5	V
DCOUT Pin Voltage		DCOUT	- 0.3 ~ VDD + 0.3	V
VRout Pin Voltage		VRout	- 0.3 ~ VDD + 0.3	V
VRout Pin Current		IRout	800	mA
VDOUT Pin Voltage		VDOUT	- 0.3 ~ VDD + 0.3	V
VDOUT Pin Current		IvD	50	mA
Lx Pin Voltage		Lx	- 0.3 ~ VDD + 0.3	V
Lx Pin Current		ILx	±1300	mA
CE/MODE Pin Voltage		CE/MODE	- 0.3 ~ VDD + 0.3	V
Power Dissipation	SOP-8	Pd	650*	mW
Operating Temperature Range		Topr	- 40 ~ + 85	°C
Storage Temperature Range		Tstg	- 55 ~ + 125	°C

(*) When PC board mounted.

ELECTRICAL CHARACTERISTICS

XC9510xxxCSx

Common Characteristics

Topr=25°C

PARAMETER	SYMBOL	CONDITIONS	MIN.	TYP.	MAX.	UNITS	CIRCUIT
Supply Current 1	IDD1	VIN=CE=DCOUT=5.0V	-	250	310	μA	1
Supply Current 2	IDD2	VIN=CE=5.0V, DCOUT=0V	-	300	360	μA	1
Stand-by Current (*1)	ISTB	VIN=6.5V, CE=0V	-	3.0	7.0	μA	1
Input Voltage Range	VIN		2.4	-	6.0	V	-
CE 'H' Level Voltage *XC9510D/E/F	VCEH		VDD-0.3	-	VDD	V	2
CE 'H' Level Voltage *XC9510H/K/L	VCEH		VDD-0.3	-	VDD	V	3
CE 'M' Level Voltage	VCEM		0.6	-	VDD-1.2	V	3
CE 'L' Level Voltage	VCEL		VSS	-	0.25	V	3
CE 'H' Level Current	ICEH		-0.1	-	0.1	μA	1
CE 'L' Level Current	ICEL		-0.1	-	0.1	μA	1

DC/DC Converter (2.2V product)

Topr=25°C

PARAMETER	SYMBOL	CONDITIONS	MIN.	TYP.	MAX.	UNITS	CIRCUIT
Supply Current 1 *XC9510D/E/F	IDD_DC1	VIN=CE=DCOUT=5.0V	-	200	280	μA	1
Supply Current 2 *XC9510D/E/F	IDD_DC2	VIN=CE=5.0V, DCOUT=0V	-	250	330	μA	1
PFM Supply Current 1 *XC9510H/K/L	IDD_PFM1	VIN=CE=DCOUT=5.0V	-	250	310	μA	1
PFM Supply Current 2 *XC9510H/K/L	IDD_PFM2	VIN=CE=5.0V, DCOUT=0V	-	300	360	μA	1
Output Voltage	DCOUT(E)	Connected to the external components, IDOUT=30mA	2.156	2.200	2.244	V	3
Oscillation Frequency	Fosc	Connected to the external components, IDOUT=10mA	1.02	1.20	1.38	MHz	3
Maximum Duty Ratio	MAXDUTY	DCOUT=0V	100	-	-	%	4
Minimum Duty Ratio	MINDUTY	DCOUT=VIN	-	-	0	%	4
PFM Duty Ratio	PFMDUTY	Connected to the external components, No load	21	30	38	%	3
U.V.L.O. Voltage (*2)	VUVLO	Connected to the external components	1.00	1.40	1.78	V	3
LX SW 'High' ON Resistance (*3)	RLXH	DCOUT=0V, LX=VIN-0.05V	-	0.5	0.9	Ω	5
LX SW 'Low' ON Resistance	RLXL	Connected to the external components, VIN=5.0V	-	0.5	0.9	Ω	3
LX SW 'High' Leak Current (*12)	IleakH	VIN=LX=6.0V, CE=0V	-	0.05	1.00	μA	11
LX SW 'Low' Leak Current (*12)	IleakL	VIN=6.0V, LX=CE=0V	-	0.05	1.00	μA	11
Maximum Output Current	I _{max1}	Connected to the external components	800	-	-	mA	3
Current Limit (*9)	I _{lim1}		1.0	1.1	-	A	6
Efficiency (*4)	EFFI	Connected to the external components, IDOUT=100mA	-	90	-	%	3
Output Voltage Temperature Characteristics	$\frac{\Delta DCOUT}{\Delta Topr \cdot DCOUT}$	IDOUT=30mA -40°C ≤ Topr ≤ 85°C	-	±100	-	ppm/ °C	3
Soft-Start Time	TSS	Connected to the external components, CE=0V → VIN, IDOUT=1mA	2	5	10	mS	3
Latch Time (*5, 10)	Tlat	Connected to the external components, VIN=CE=5.0V, Short DCOUT by 1Ω resistor	-	8	25	mS	10

■ ELECTRICAL CHARACTERISTICS (Continued)

XC9510xxxCSx (Continued)

● Regulator (1.8V product)

Topr=25°C

PARAMETER	SYMBOL	CONDITIONS	MIN.	TYP.	MAX.	UNITS	CIRCUIT
Output Voltage	VR _{OUT} (E)	IR _{OUT} =30mA	1.764	1.800	1.836	V	2
Maximum Output Current	I _{max2}		400	-	-	mA	2
Load Regulation	ΔVR _{OUT}	1mA ≤ IR _{OUT} ≤ 100mA	-	15	50	mV	2
Dropout Voltage 1 (*6)	V _{dif 1}	IR _{OUT} =100mA	-	100	200	mV	2
Dropout Voltage 2	V _{dif 2}	IR _{OUT} =200mA	-	200	400	mV	2
Line Regulation	$\frac{\Delta VR_{OUT}}{\Delta V_{IN} \cdot VR_{OUT}}$	IR _{OUT} =30mA VR _{OUT} (T)+1V ≤ VIN ≤ 6V	-	0.05	0.25	%/V	2
Current Limit	I _{lim2}	VR _{OUT} =VR _{OUT} (E) x 0.9	480	600	-	mA	7
Short-Circuit Current	I _{short}	VR _{OUT} =VSS	-	30	-	mA	7
Ripple Rejection Rate	PSRR	VIN={VOUT(T)+1.0} VDC+0.5Vp-pAC, IR _{OUT} =30mA, f=1kHz	-	60	-	dB	12
Output Voltage Temperature Characteristics	$\frac{\Delta VR_{OUT}}{\Delta Topr \cdot VR_{OUT}}$	IR _{OUT} =30mA -40°C ≤ Topr ≤ 85°C	-	±100	-	ppm/ °C	2

● Detector (2.7V product)

PARAMETER	SYMBOL	CONDITIONS	MIN.	TYP.	MAX.	UNITS	CIRCUIT
Detect Voltage	V _{DF} (E)	CE=0V	2.646	2.700	2.754	V	8
Hysteresis Range	V _{HYS}	V _{HYS} =[V _{DR} (E) ^{(*)11} - V _{DF} (E)] / V _{DF} (E) x 100	2	5	8	%	8
VD Output Current	I _{VD}	V _{DOUT} =0.5V, CE=0V	1	-	-	mA	9
Output Voltage Temperature Characteristics	$\frac{\Delta V_{DF}}{\Delta Topr \cdot V_{DF}}$	-40°C ≤ Topr ≤ 85°C	-	±100	-	ppm/ °C	8

Test conditions: Unless otherwise stated:

DC/DC : VIN=3.6V [@ DC_{OUT}:2.2V]

VR: VIN = 2.8V (VIN=VR_{OUT}(T) + 1.0V)

VD: VIN=5.0V

Common conditions for all test items: CE=VIN, MODE=0V

* VR_{OUT}(T) : Setting output voltage

NOTE:

*1 : Including VD supply current (VD operates when in stand-by mode.)

*2 : Including hysteresis operating voltage range.

*3 : ON resistance (Ω) = 0.05 (V) / ILX (A)

*4 : EFFI = { (Output Voltage x Output Current) / (Input Voltage x Input Current) } x 100

*5 : Time until it short-circuits DC_{OUT} with GND through 1Ω of resistance from a state of operation and is set to DC_{OUT}=0V from current limit pulse generating.

6 : V_{dif} = (VIN^{()7} - VR_{OUT1}^{(*)8})

*7 : VIN 1 = The input voltage when VR_{OUT1} appears as input voltage is gradually decreased.

*8 : VR_{OUT1} = A voltage equal to 98% of the output voltage whenever an amply stabilized I_{OUT} {VR_{OUT}(T) + 1.0V} is input.

*9 : Current limit = When VIN is low, limit current may not be reached because of voltage falls caused by ON resistance or serial resistance of coils.

*10: Integral latch circuit=latch time may become longer and latch operation may not work when VIN is 3.0V or more.

*11: V_{DR}(E) = VD release voltage

*12: When temperature is high, a current of approximately 5.0 μA (maximum) may leak.

TEST CIRCUITS

Circuit 1 Supply Current, Stand-by Current, CE Current

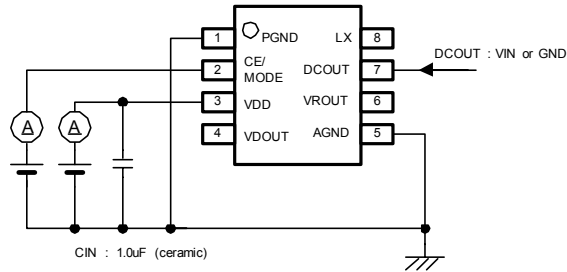

Circuit 2 Output Voltage (VR), Load Regulation, Dropout Voltage, Maximum Output Current, (MODE Voltage)

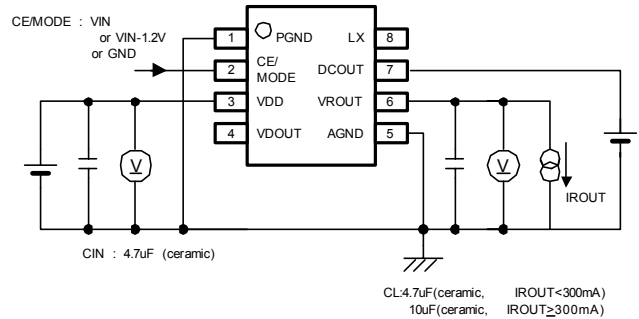

Circuit 3 Output Voltage (DC/DC) Oscillation Frequency, U.V.L.O. Voltage, Soft-start Time, CE Voltage, Maximum Output Current, Efficiency, (PFM Duty Cycle), (MODE Voltage)

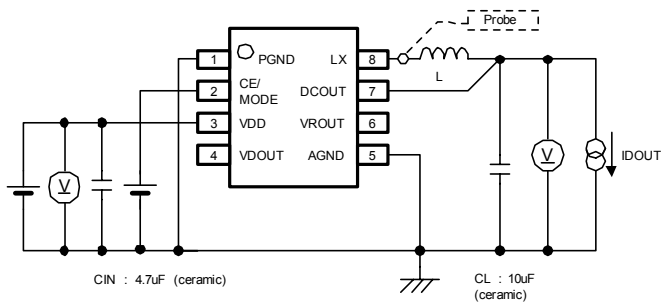

Fosc	L
300kHz	22uH (CDRH6D38, SUMIDA)
600kHz	10uH (CDRH5D28, SUMIDA)
1.2MHz	4.7uH (CDRH4D28C, SUMIDA)

Circuit 4 Minimum Duty Cycle, Maximum Duty Cycle

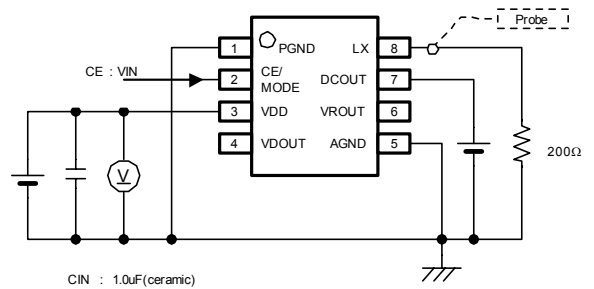

Circuit 5 Lx ON Resistance

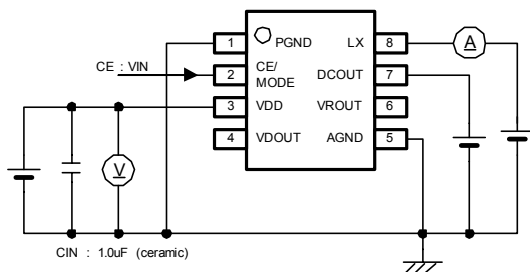

Circuit 6 Current Limit 1 (DC/DC)

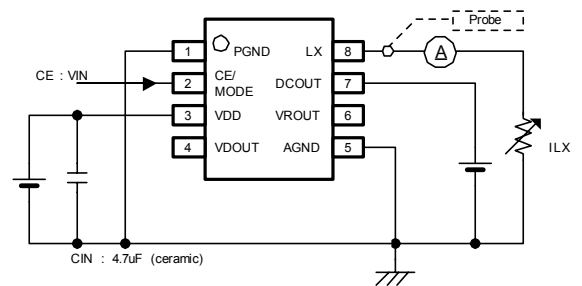

TEST CIRCUITS (Continued)

Circuit 7 Current Limit 2 (VR), Short Circuit Current (VR)

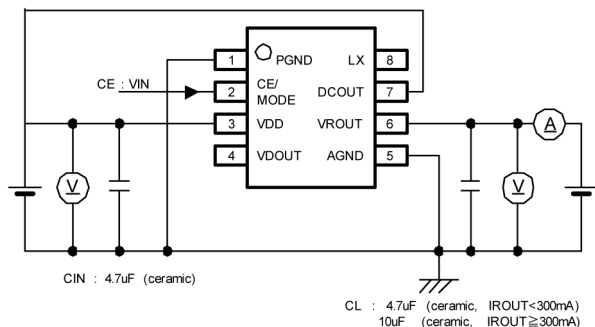

Circuit 8 Detect Voltage, Release Voltage (Hysteresis Range)

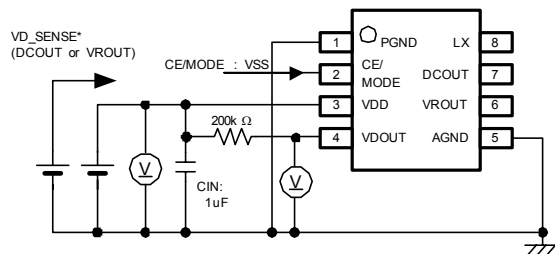

* For the measurement of the VDD_Sense products, the input voltage was controlled.

Circuit 9 VD Output Current

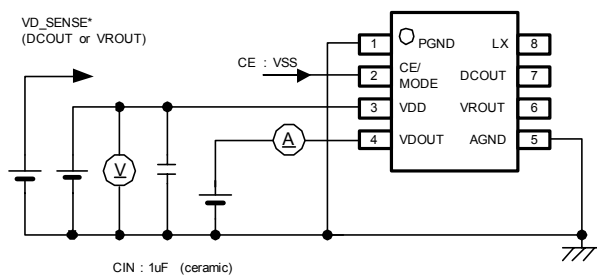

* For the measurement of the VDD_Sense products, the input voltage was controlled.

Circuit 10 Latch Time

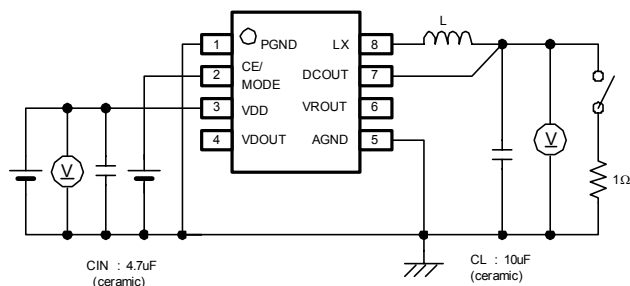

Fosc	L
300kHz	22uH(CDRH6D38, SUMIDA)
600kHz	10uH(CDRH5D28, SUMIDA)
1.2MHz	4.7uH(CDRH4D28C, SUMIDA)

Circuit 11 Off-Leak

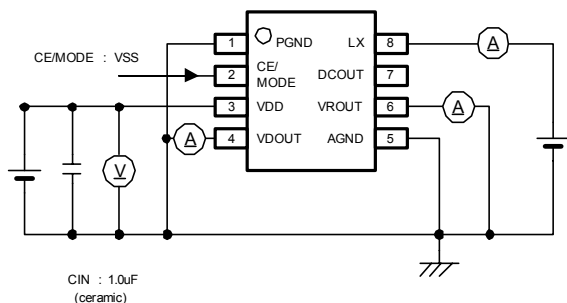

Circuit 12 Ripple Rejection Rate

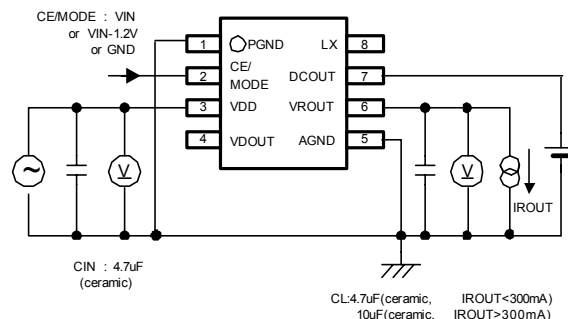

TYPICAL APPLICATION CIRCUIT

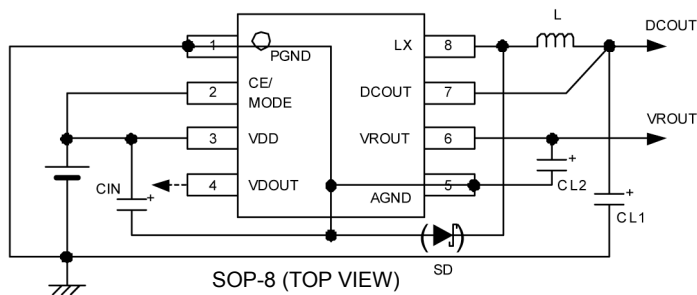

FOSC	L
1.2MHz	4.7 μ H (CDRH4D28C, SUMIDA)
600kHz	10 μ H (CDRH5D28, SUMIDA)
300kHz	22 μ H (CDRH6D28, SUMIDA)

CIN	CL1	CL2 *2	
4.7 μ F (ceramic, TAIYO YUDEN)	10 μ F (ceramic, TAIYO YUDEN)	IROUT<300mA	4.7 μ F (ceramic, TAIYO YUDEN)
		IROUT \geq 300mA	10 μ F (ceramic, TAIYO YUDEN)

*1 The DC/DC converter of the XC9510 series automatically switches between synchronous / non-synchronous. The Schottky diode is not normally needed. However, in cases where high efficiency is required when using the DC/DC converter during in the light load while in non-synchronous operation, please connect a Schottky diode externally.

*2 Please be noted that the recommend value above of the CL2 may be changed depending on the input voltage value and setting voltage value.

OPERATIONAL EXPLANATION

The XC9510 series consists of a synchronous step-down DC/DC converter, a high speed LDO voltage regulator, and a voltage detector. Since the LDO voltage regulator is stepped-down from the DC/DC's output, high efficiency and low noise is possible even at lower output voltages.

●DC/DC Converter

The series consists of a reference voltage source, ramp wave circuit, error amplifier, PWM comparator, phase compensation circuit, output voltage adjustment resistors, driver transistor, synchronous switch, current limiter circuit, U.V.L.O. circuit and others. The series ICs compare, using the error amplifier, the voltage of the internal voltage reference source with the feedback voltage from the VOUT pin through split resistors. Phase compensation is performed on the resulting error amplifier output, to input a signal to the PWM comparator to determine the turn-on time during PWM operation. The PWM comparator compares, in terms of voltage level, the signal from the error amplifier with the ramp wave from the ramp wave circuit, and delivers the resulting output to the buffer driver circuit to cause the Lx pin to output a switching duty cycle. This process is continuously performed to ensure stable output voltage. The current feedback circuit monitors the P-channel MOS driver transistor current for each switching operation, and modulates the error amplifier output signal to provide multiple feedback signals. This enables a stable feedback loop even when a low ESR capacitor, such as a ceramic capacitor, is used, ensuring stable output voltage.

<Reference Voltage Source>

The reference voltage source provides the reference voltage to ensure stable output voltage of the DC/DC converter.

<Ramp Wave Circuit>

The ramp wave circuit determines switching frequency. The frequency is fixed internally and can be selected from 300kHz, 600 kHz and 1.2 MHz. Clock pulses generated in this circuit are used to produce ramp waveforms needed for PWM operation, and to synchronize all the internal circuits.

<Error Amplifier>

The error amplifier is designed to monitor output voltage. The amplifier compares the reference voltage with the feedback voltage divided by the internal split resistors. When a voltage lower than the reference voltage is fed back, the output voltage of the error amplifier increases. The gain and frequency characteristics of the error amplifier output are fixed internally to deliver an optimized signal to the mixer.

■ OPERATIONAL EXPLANATION (Continued)

<PWM/PFM>

The XC9510A to F series are PWM control, while the XC9510H to L series can be automatically switched between PWM control and PWM/PFM control. The PWM of the XC9510A to F series are controlled on a specified frequency from light loads through the heavy loads. Since the frequency is specified, the composition of a noise filter etc. becomes easy. However, the efficiency at the time of the light load may become low.

The XC9510H to L series can switch in any timing between PWM control and PWM/PFM automatic switching control. The series cannot control only PFM mode. If needed, the operation can be set on a specified frequency; therefore, the control of the noise etc. is possible and the high efficiency at the time of the light load during PFM control mode is possible. With the automatic PWM/PFM switching control function, the series ICs are automatically switched from PWM control to PFM control mode under light load conditions. If during light load conditions the coil current becomes discontinuous and on-time rate falls lower than 30%, the PFM circuit operates to output a pulse with 30% of a fixed on-time rate from the Lx pin. During PFM operation with this fixed on-time rate, pulses are generated at different frequencies according to conditions of the moment. This causes a reduction in the number of switching operations per unit of time, resulting in efficiency improvement under light load conditions. However, since pulse output frequency is not constant, consideration should be given if a noise filter or the like is needed. Necessary conditions for switching to PFM operation depend on input voltage, load current, coil value and other factors.

<Synchronous / Non-synchronous>

The XC9510 series automatically switches between synchronous / non-synchronous according to the state of the DC/DC converter.

Highly efficient operations are achievable using the synchronous mode while the coil current is in a continuous state.

The series enters non-synchronous operation when the built-in N-ch switching transistor for synchronous operation is shutdown which happens when the load current becomes low and the operation changes to a discontinuous state.

The IC can operate without an external schottky diode because the parasitic diode in the N-ch switching transistor provides the circuit's step-down operation. However, since V_f of the parasitic diode is a high 0.6V, the efficiency level during non-synchronous operation shows a slight decrease. Please use an external schottky diode if high efficiency is required during light load current.

● Continuous Mode: Synchronous

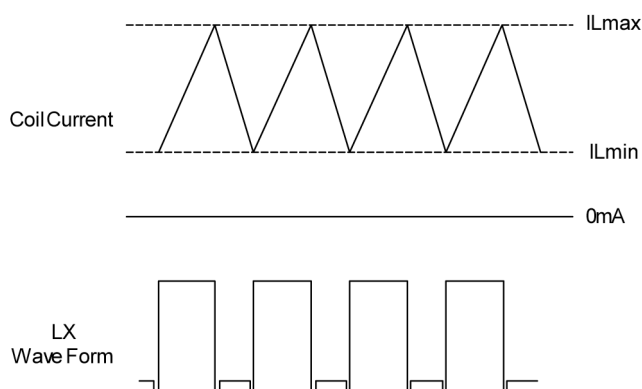

● Discontinuous Mode: Non-Synchronous

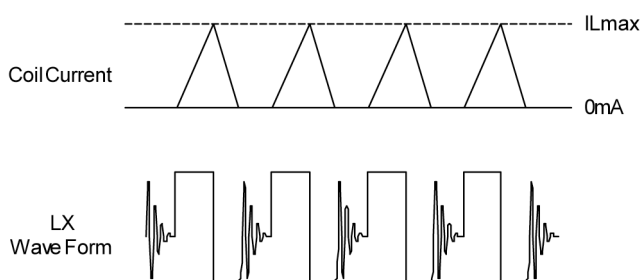

■ OPERATIONAL EXPLANATION (Continued)

<Current Limit>

The current limiter circuit of the XC9510 series monitors the current flowing through the P-channel MOS driver transistor connected to the Lx pin, and features a combination of the constant-current type current limit mode and the operation suspension mode.

- ① When the driver current is greater than a specific level, the constant-current type current limit function operates to turn off the pulses from the Lx pin at any given timing.
- ② When the driver transistor is turned off, the limiter circuit is then released from the current limit detection state.
- ③ At the next pulse, the driver transistor is turned on. However, the transistor is immediately turned off in the case of an over current state.
- ④ When the over current state is eliminated, the IC resumes its normal operation.

The IC waits for the over current state to end by repeating the steps ① through ③. If an over current state continues for 8msec* and the above three steps are repeatedly performed, the IC performs the function of latching the OFF state of the driver transistor, and goes into operation suspension mode. Once the IC is in suspension mode, operations can be resumed by either turning the IC off via the CE/MODE pin, or by restoring power to the VIN pin. The suspension mode does not mean a complete shutdown, but a state in which pulse output is suspended; therefore, the internal circuitry remains in operation. The constant-current type current limit of the XC9510 series can be set at 1.1A.

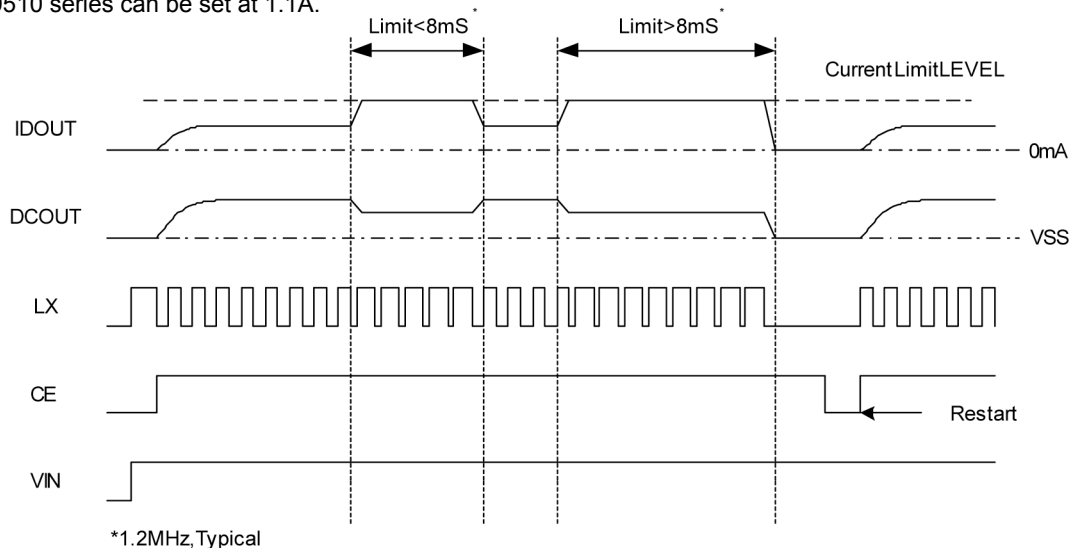

<U.V.L.O. Circuit>

When the VIN pin voltage becomes 1.4 V or lower, the P-channel output driver transistor is forced OFF to prevent false pulse output caused by unstable operation of the internal circuitry. When the VIN pin voltage becomes 1.8 V or higher, switching operation takes place. By releasing the U.V.L.O. function, the IC performs the soft start function to initiate output startup operation. The soft start function operates even when the VIN pin voltage falls momentarily below the U.V.L.O. operating voltage. The U.V.L.O. circuit does not cause a complete shutdown of the IC, but causes pulse output to be suspended; therefore, the internal circuitry remains in operation.

● High Speed LDO Voltage Regulator

The voltage regulator block of the XC9510 series consists of a reference voltage source, error amplifier, and current limiter circuit. The voltage divided by split resistors is compared with the internal reference voltage by the error amplifier. The P-channel MOSFET, which is connected to the VRout pin, is then driven by the subsequent output signal. The output voltage at the VRout pin is controlled and stabilized by a system of negative feedback. A stable output voltage is achievable even if used with low ESR capacitors as a phase compensation circuit is built-in.

<Reference Voltage Source>

The reference voltage source provides the reference voltage to ensure stable output voltage of the regulator.

<Error Amplifier>

The error amplifier compares the reference voltage with the signal from VRout, and the amplifier controls the output of the P-ch driver transistor.

<Current Limit Circuit>

The voltage regulator block includes a combination of a constant current limiter circuit and a foldback circuit. When the load current reaches the current limit level, the current limiter circuit operates and the output voltage of the voltage regulator block drops. As a result of this drop in output voltage, the foldback circuit operates, output voltage drops further and the load current decreases. When the VRout and GND pin are shorted, the load current of about 30mA flows.

■ OPERATIONAL EXPLANATION (Continued)

● Voltage Detector

The detector block of the XC9510 series detects output voltage from the VDOUT pin while sensing either VDD, DCOUT, or VRout internally. (N-channel Open Drain Type)

< CE / MODE Pin Function >

The operation of the XC9510 series' DC/DC converter block and voltage regulator block will enter into the shut down mode when a low level signal is input to the CE/MODE pin. During the shut down mode, the current consumption occurs only in the detector and is $3.0 \mu\text{A}$ (TYP.), with a state of high impedance at the Lx pin and DCOUT pin. The IC starts its operation by inputting a high level signal or a middle level signal to the CE/MODE pin. The input to the CE/MODE pin is a CMOS input and the sink current is $0 \mu\text{A}$ (TYP.). The operation of the XC9510D to F series' voltage detector block will enter into stand-by mode when a high level signal is input to the CE/MODE pin. The voltage regulator block will operate when a middle level signal is input. But when a low level signal is input, the voltage regulator block will enter into stand-by mode. With the XC9510H to L series control can be PWM control when the CE/MODE pin is 'M' level and PWM/PFM automatic switching control when the CE/MODE pin is 'H' level.

■ NOTES ON USE

● Application Information

1. The XC9510 series is designed for use with ceramic output capacitors. If, however, the potential difference between dropout voltage or output current is too large, a ceramic capacitor may fail to absorb the resulting high switching energy and oscillation could occur on the output. If the input-output potential difference is large, connect an electrolytic capacitor in parallel to compensate for insufficient capacitance.
2. Spike noise and ripple voltage arise in a switching regulator as with a DC/DC converter. These are greatly influenced by external component selection, such as the coil inductance, capacitance values, and board layout of external components. Once the design has been completed, verification with actual components should be done.
3. When the difference between VIN and VOUT is large in PWM control, very narrow pulses will be outputted, and there is the possibility that some cycles may be skipped completely.
4. When the difference between VIN and VOUT is small, and the load current is heavy, very wide pulses will be outputted and there is the possibility that some cycles may be skipped completely: in this case, the Lx pin may not go low at all.

● DC/DC Waveform (3.3V, 1.2MHz)

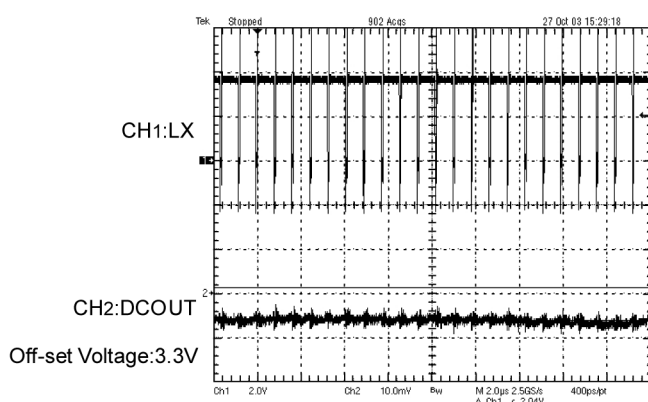

< External Components >
L: $4.7 \mu\text{H}$ (CDRH4D28C, SUMIDA)
CIN: $4.7 \mu\text{F}$ (ceramic)
CL: $10 \mu\text{F}$ (ceramic)

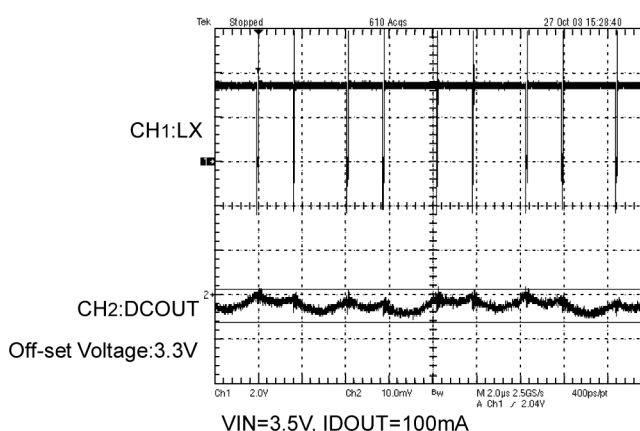

< External Components >
L: $4.7 \mu\text{H}$ (CDRH4D28C, SUMIDA)
CIN: $4.7 \mu\text{F}$ (ceramic)
CL: $10 \mu\text{F}$ (ceramic)

■ NOTES ON USE (Continued)

● Application Information (Continued)

- The IC's DC/DC converter operates in synchronous mode when the coil current is in a continuous state and non-synchronous mode when the coil current is in a discontinuous state. In order to maintain the load current value when synchronous switches to non-synchronous and vice versa, a ripple voltage may increase because of the repetition of switching between synchronous and non-synchronous. When this state continues, the increase in the ripple voltage stops. To reduce the ripple voltage, please increase the load capacitance value or use a schottky diode externally. When the current used becomes close to the value of the load current when synchronous switches to non-synchronous and vice versa, the switching current value can be changed by changing the coil inductance value. In case changes to coil inductance are to values other than the recommended coil inductance values, verification with actual components should be done.

$$I_{cs} = (V_{IN} - DC_{OUT}) \times \text{OnDuty} / (L \times F_{osc})$$

I_{cs} : Switching current from synchronous rectification to non-synchronous rectification
 OnDuty: OnDuty ratio of P-ch driver transistor (=step down ratio : DC_{OUT} / V_{IN})
 L: Coil inductance value
 F_{osc} : Oscillation frequency
 ID_{OUT} : The DC/DC load current
 (the sum of the DC/DC's and the regulator's load if the regulator has load.)

- When the XC9510H to L series operates in PWM/PFM automatic switching control mode, the reverse current may become quite high around the load current value when synchronous switches to non-synchronous and vice versa (also refer to no. 5 above). Under this condition, switching synchronous rectification and non-synchronous rectification may be repeated because of the reverse current, and the ripple voltage may be increased to 100mV or more. The reverse current is the current that flows in the PGND direction through the N-ch driver transistor from the coil. The conditions which cause this operation are as follows.

$$\text{PFM Duty} < \text{Step down ratio} = DC_{OUT} / V_{IN} \times 100 (\%)$$

PFM Duty: 30% (TYP.)

Please switch to PWM control via the MODE function in cases where the load current value of the DC/DC converter is close to synchronous.

● DC/DC Waveform (1.8V, 600kHz) @ $V_{IN}=6.0V$

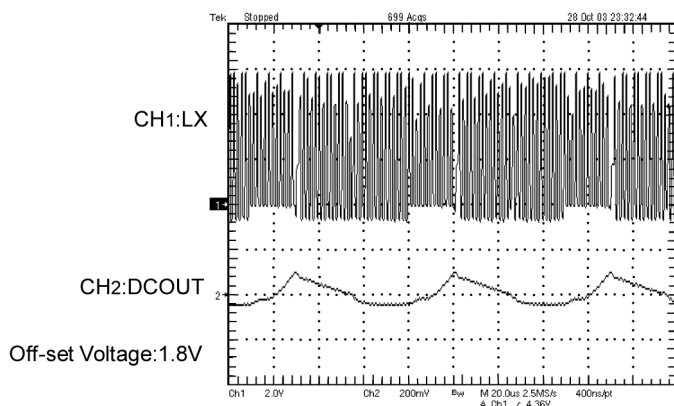

$V_{IN}=6.0V, ID_{OUT}=50mA$

< External Components >

L: $10 \mu H$ (CDRH5D28C, SUMIDA)

CIN: $4.7 \mu F$ (ceramic)

CL: $10 \mu F$ (ceramic)

Step down ratio : $1.8V / 6.0V = 30\%$ <PFM Duty 31%>

■ NOTES ON USE (Continued)

● Application Information (Continued)

- With the DC/DC converter of the IC, the peak current of the coil is controlled by the current limit circuit. Since the peak current increases when dropout voltage or load current is high, current limit starts operating, and this can lead to instability. When peak current becomes high, please adjust the coil inductance value and fully check the circuit operation. In addition, please calculate the peak current according to the following formula:

$$\text{Peak current: } I_{pk} = (V_{IN} - DC_{OUT}) \times \text{OnDuty} / (2 \times L \times F_{osc}) + ID_{OUT}$$

- When the peak current, which exceeds limit current flows within the specified time, the built-in driver transistor is turned off (the integral latch circuit). During the time until it detects limit current and before the built-in transistor can be turned off, the current for limit current flows; therefore, care must be taken when selecting the rating for the coil or the Schottky diode.
- When V_{IN} is low, limit current may not be reached because of voltage falls caused by ON resistance or serial resistance of the coil.
- In the integral latch circuit, latch time may become longer and latch operation may not work when V_{IN} is 3.0V or more.
- Use of the IC at voltages below the recommended voltage range may lead to instability.
- This IC and the external components should be used within the stated absolute maximum ratings in order to prevent damage to the device.
- Since the DC/DC converter and the regulator of the XC9510 series are connected in series, the sum of the output current (ID_{OUT}) of the DC/DC and the output current (IR_{OUT}) of the VR makes the current flows inside the DC/DC converter. Please be careful of the power dissipation when in use. Please calculate power dissipation by using the following formula.

$$P_d = P_{dDC/DC} + P_{dVR}$$

DC/DC power dissipation (when in synchronous operation) : $P_{dDC/DC} = ID_{OUT}^2 \times RON$

VR power dissipation: $P_{dVR} = (DC_{OUT} - VR_{OUT}) \times IR_{OUT}$

RON : ON resistance of the built-in driver transistor to the DC/DC (= $0.5\Omega <TYP.>$)

$$RON = R_{pon} \times P\text{-chOnDuty} / 100 + R_{non} \times (1 - P\text{-chOnDuty} / 100)$$

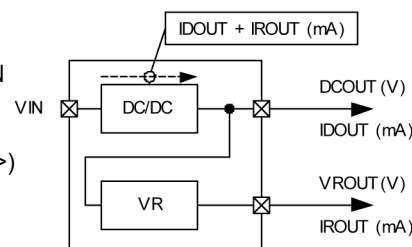

- The voltage detector circuit built-in the XC9510 series internally monitor the V_{DD} pin voltage, the DC/DC output pin voltage and VR output pin voltage. For the XC9510B/C/E/F/K/L series, which voltage detector circuit monitors the DC/DC output pin voltage and the VR output pin voltage, please determine the detect voltage value (VDF) by the following equation.

$$VDF \leq (\text{Setting voltage on both the } DC_{OUT} \text{ voltage and the } VR_{OUT} \text{ voltage}) \times 85\%^*$$

* An assumed value of tolerance among the DC_{OUT} voltage, the VR_{OUT} voltage, and the VD release voltage (The VD detect voltage and hysteresis range).

■NOTES ON USE (Continued)

●Instructions on Pattern Layout

1. In order to stabilize V_{IN} 's voltage level, we recommend that a by-pass capacitor (C_{IN}) be connected as close as possible to the V_{DD} & AGND pins. This IC is the composite IC of the DC/DC converter and regulator. Fluctuation of the V_{IN} 's voltage level causes mutual interference.
2. Please mount each external component as close to the IC as possible.
3. Wire external components as close to the IC as possible and use thick, short connecting traces to reduce the circuit impedance.
4. Make sure that the PCB GND traces are as thick as possible, as variations in ground potential caused by high ground currents at the time of switching may result in instability of the DC/DC converter and have adverse influence on the regulator output.
5. If using a Schottky diode, please connect the anode side to the AGND pin through C_{IN} . Characteristic degradation caused by the noise may occur depending on the arrangement of the Schottky diode.

<SOP-8 Recommended pattern layout>

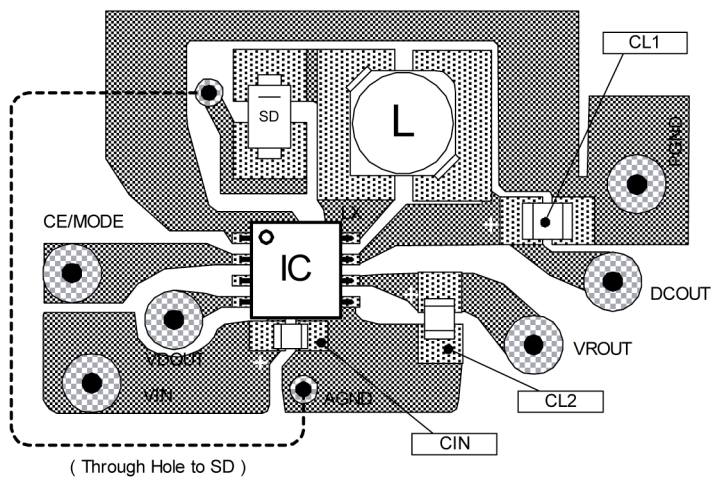

TYPICAL PERFORMANCE CHARACTERISTICS

(A) DC/DC CONVERTER

(1) Efficiency vs. Output Current

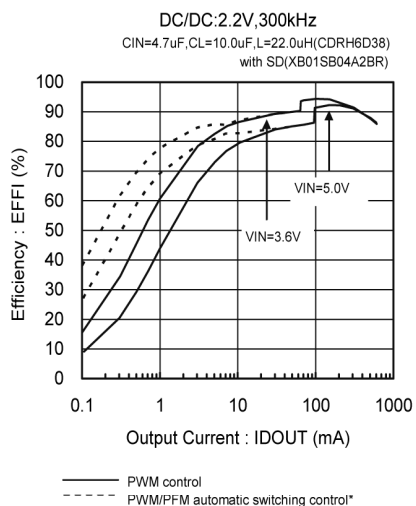
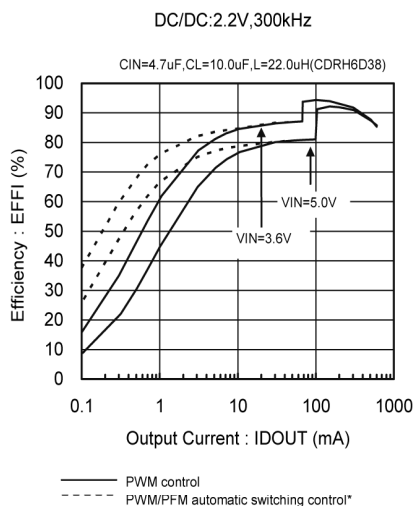
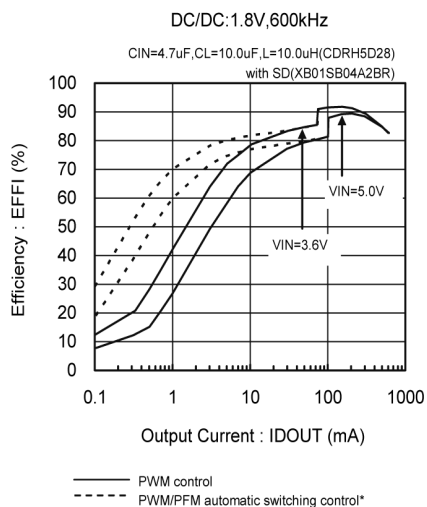
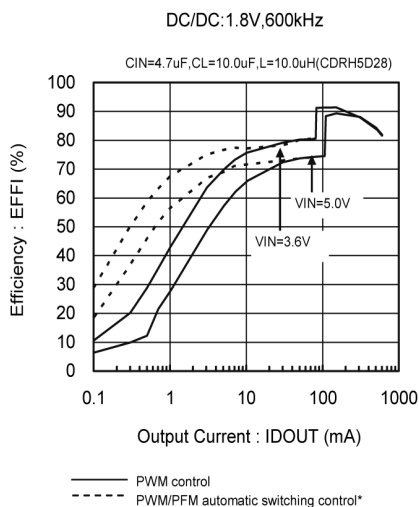
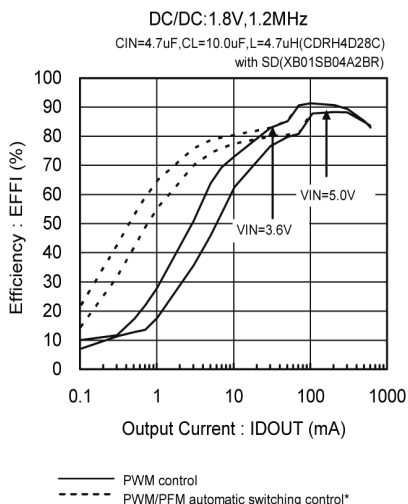
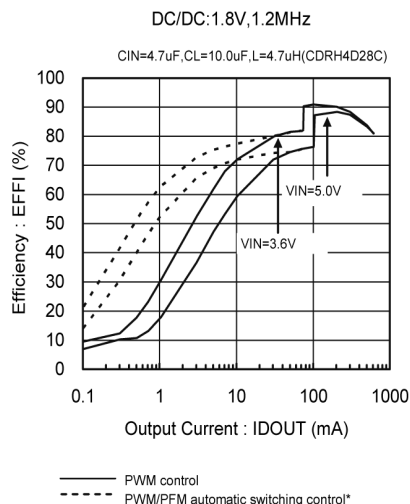

*XC9510H/K/L series only

TYPICAL PERFORMANCE CHARACTERISTICS (Continued)

(A) DC/DC CONVERTER (Continued)

(2) Output Voltage vs. Output Current

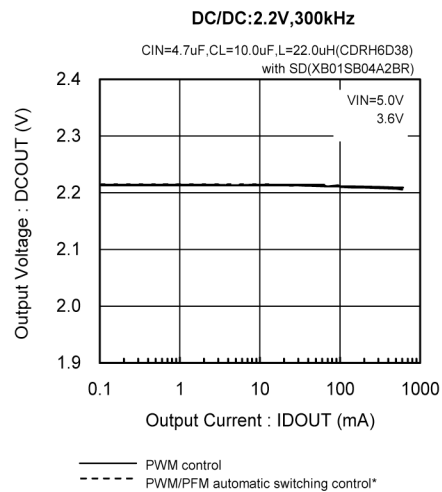
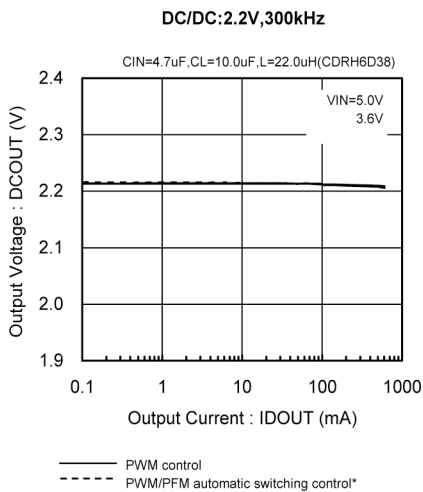
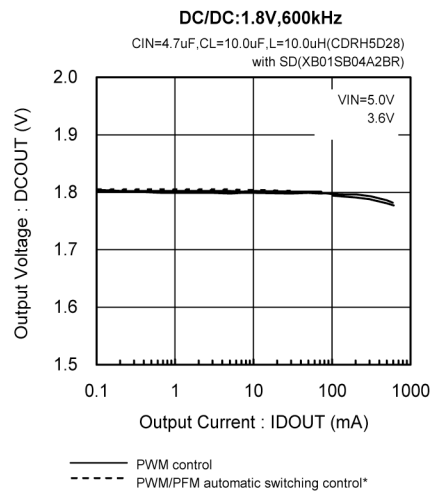
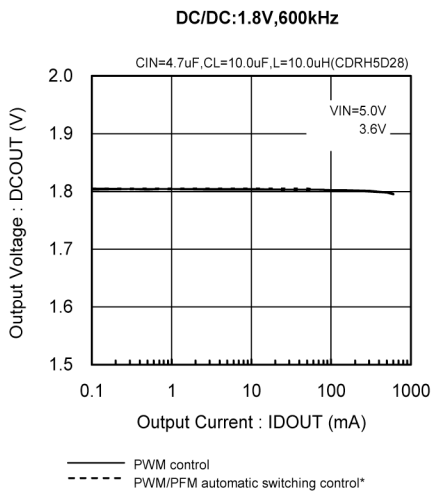
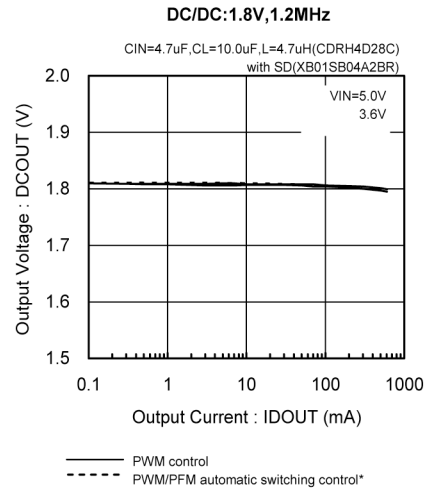
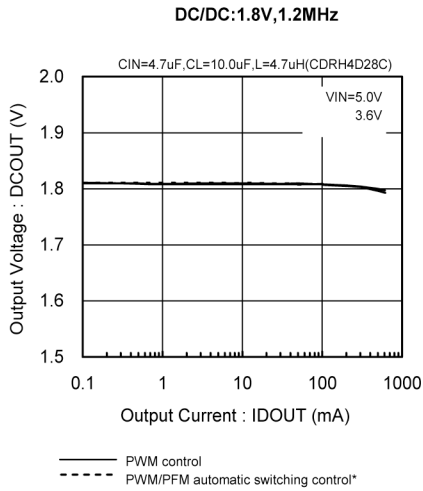

*XC9510H/K/L series only

■ TYPICAL PERFORMANCE CHARACTERISTICS (Continued)

(A) DC/DC CONVERTER (Continued)

(3) Output Voltage vs. Ripple Voltage

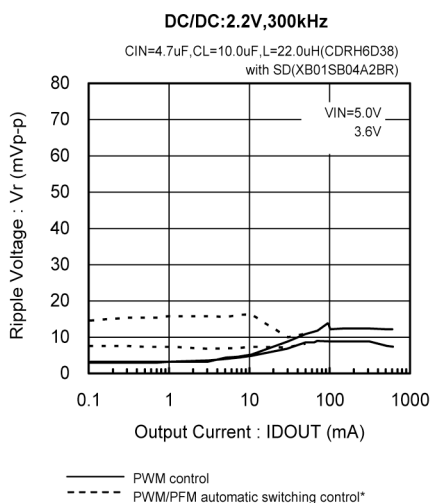
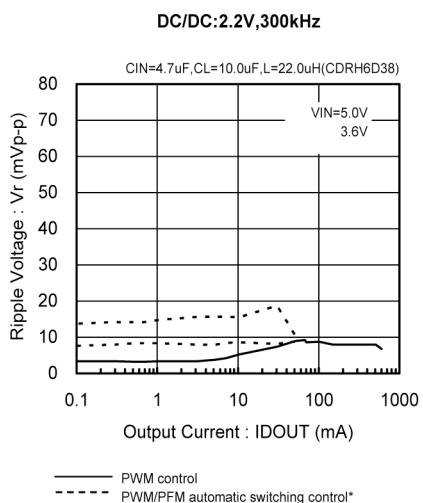
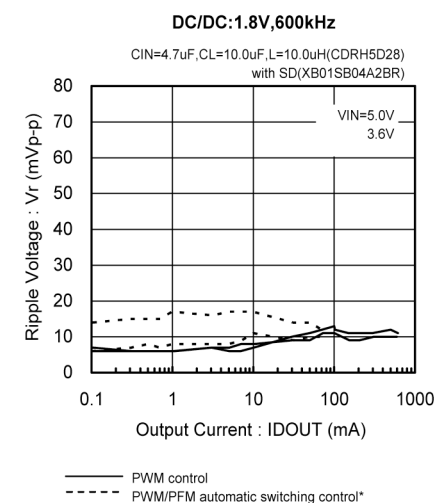
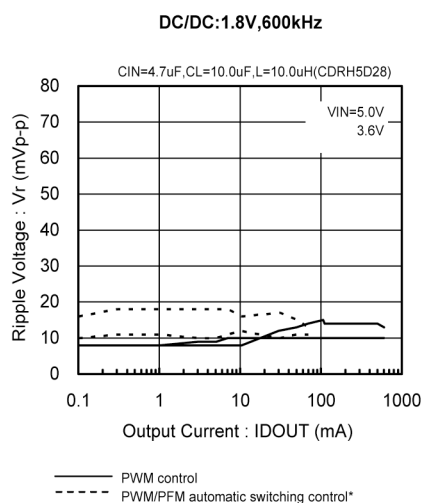
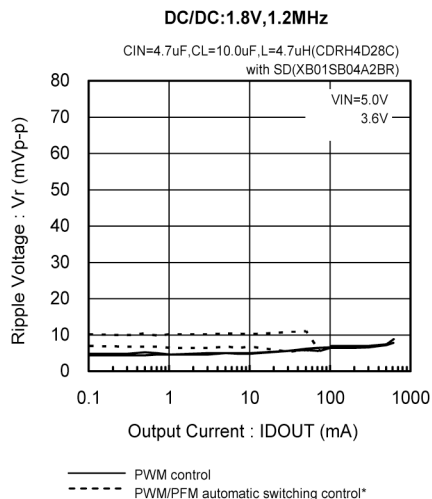
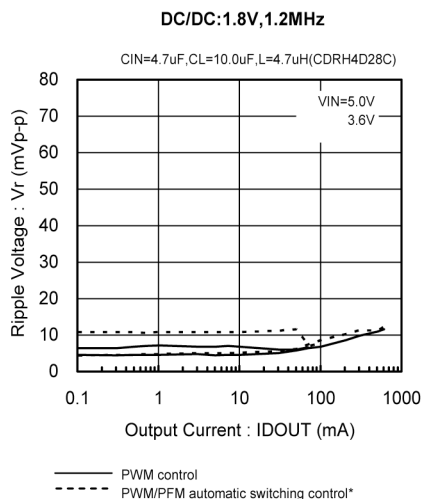

*XC9510H/K/L series only

■ TYPICAL PERFORMANCE CHARACTERISTICS (Continued)

(A) DC/DC CONVERTER (Continued)

(4) Output Voltage vs. Ambient Temperature

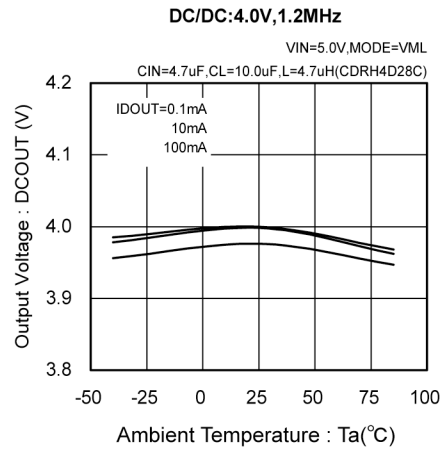
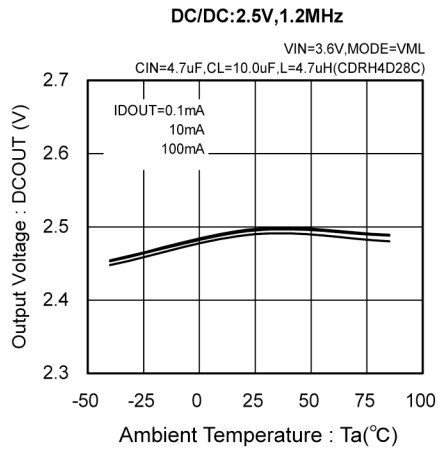

(5) Soft Start Time vs. Ambient Temperature

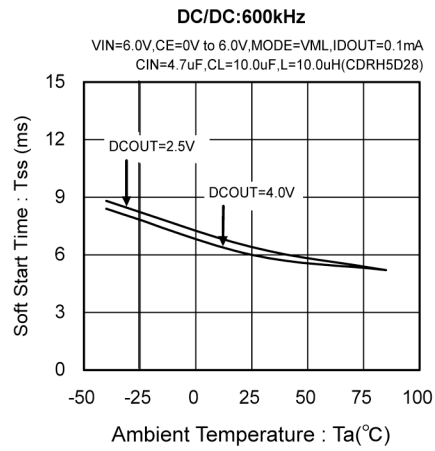
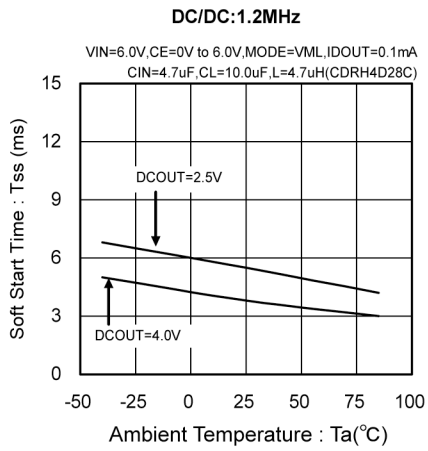

■ TYPICAL PERFORMANCE CHARACTERISTICS (Continued)

(A) DC/DC CONVERTER (Continued)

(6) DC/DC Supply Current vs. Ambient Temperature(VR:Shutdown)*

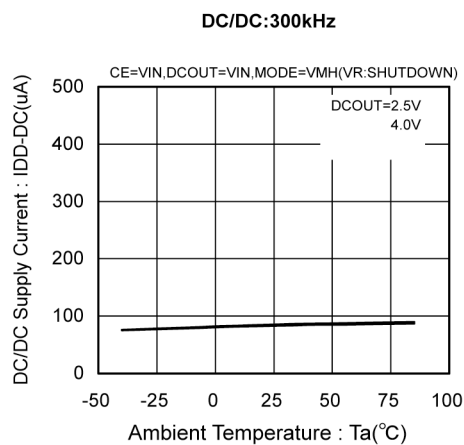
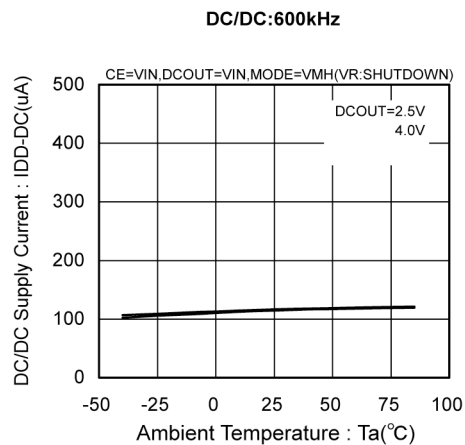
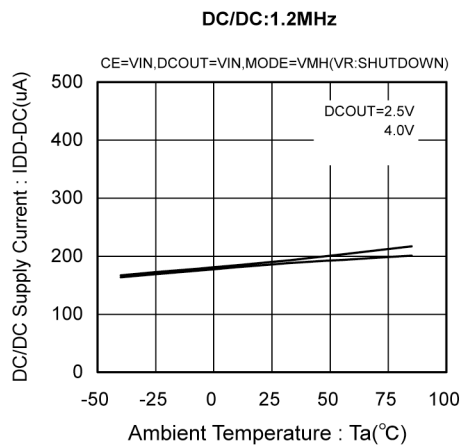

*XC9510D/E/F series only

■ TYPICAL PERFORMANCE CHARACTERISTICS (Continued)

(A) DC/DC CONVERTER (Continued)

(7) LX P-ch/N-ch On Resistance vs. Input Voltage

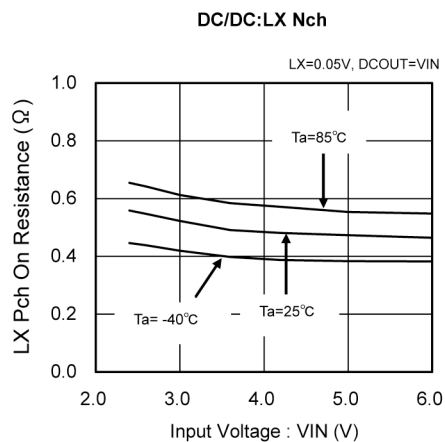
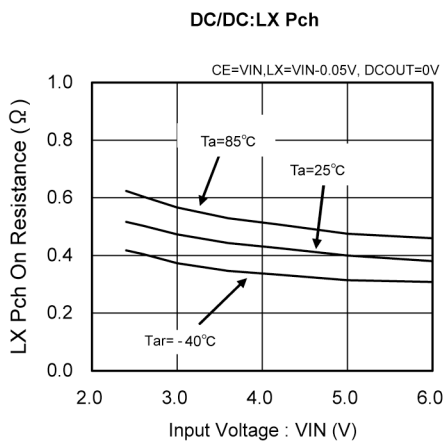

(8) Oscillation Frequency vs. Ambient Temperature

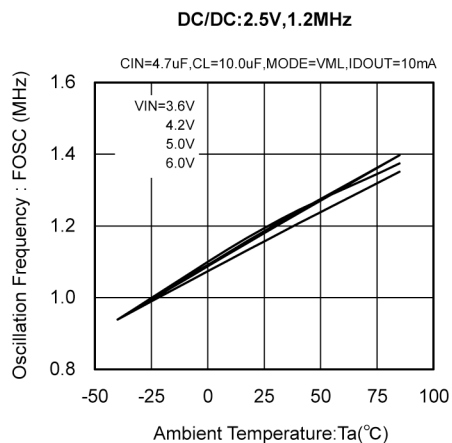

(9) U.V.L.O. Voltage vs. Ambient Temperature

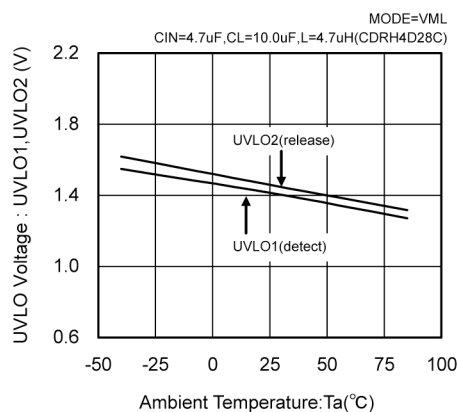

TYPICAL PERFORMANCE CHARACTERISTICS (Continued)

(A) DC/DC CONVERTER (Continued)

(10-2) DC/DC Load Transient Response (*DCOUT:3.3V FOSC:1.2MHz)

(a) PWM Control

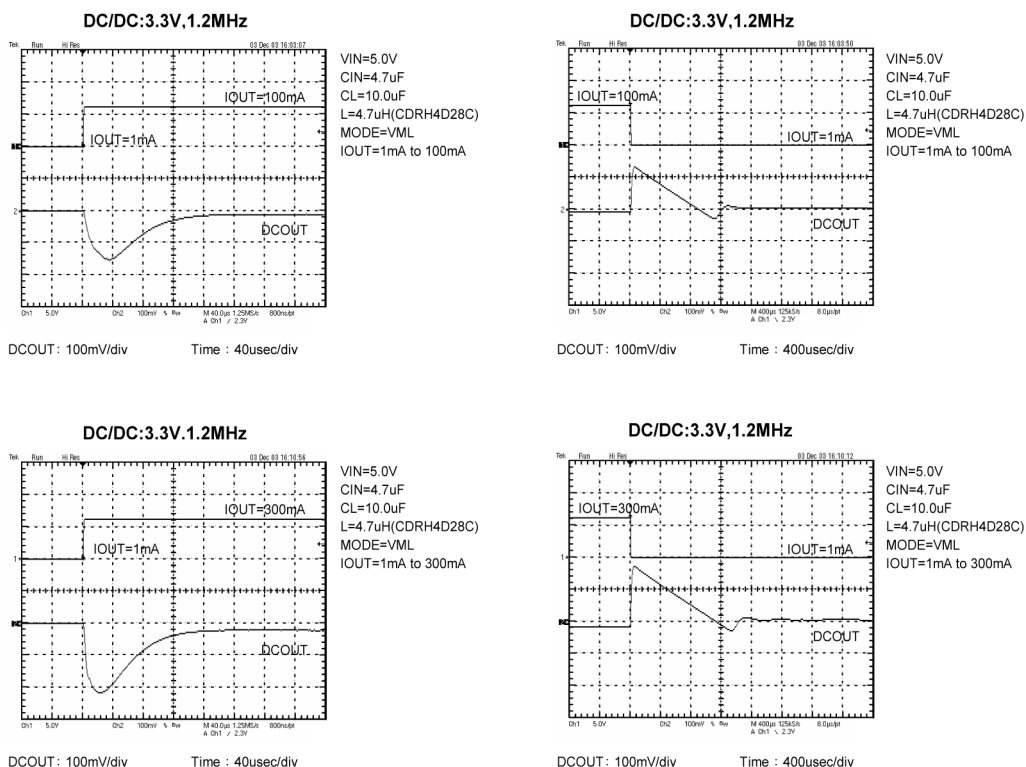

(b) PWM/PFM Automatic Switching Control* (*XC9510H/K/L Series Only)

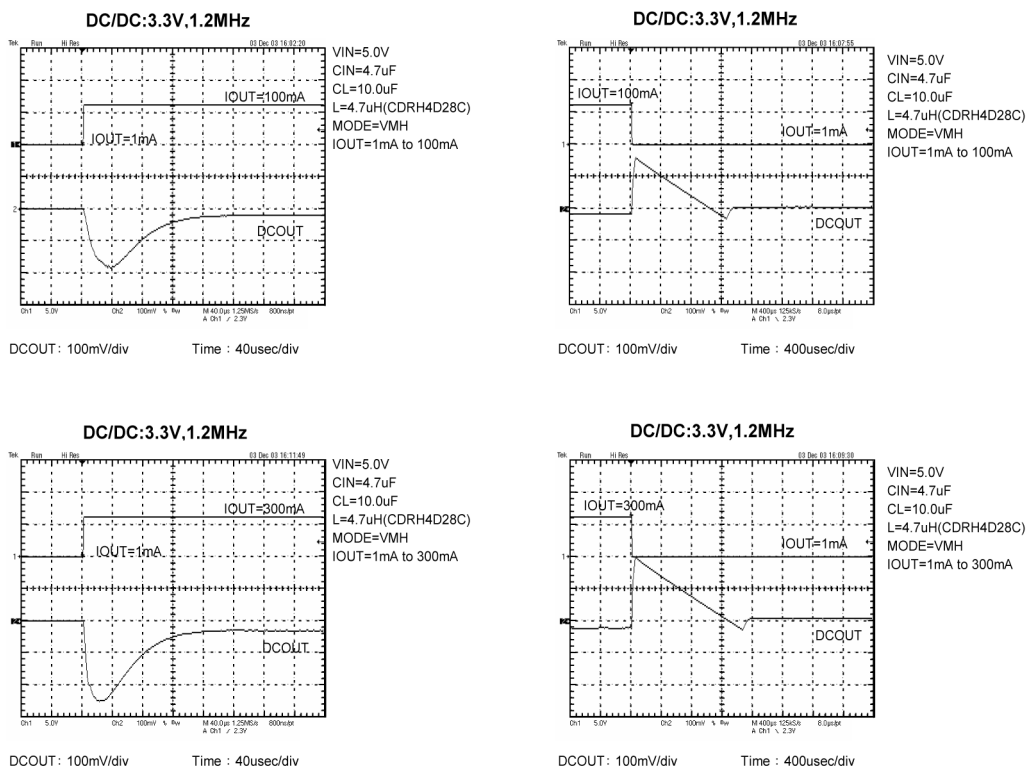

TYPICAL PERFORMANCE CHARACTERISTICS (Continued)

(A) DC/DC CONVERTER (Continued)

(10-3) DC/DC Load Transient Response (*DCOUT:1.8V FOSC:600kHz)

(a) PWM Control

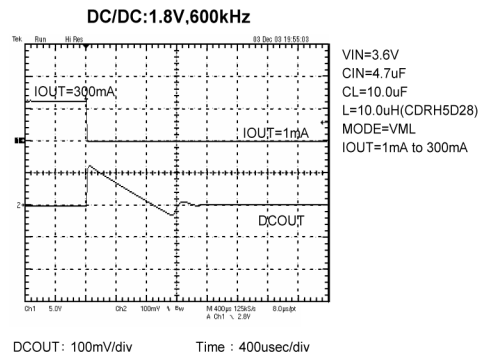
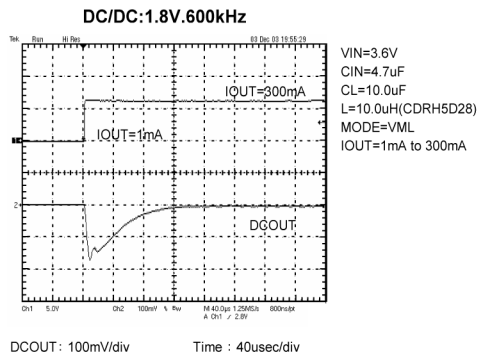
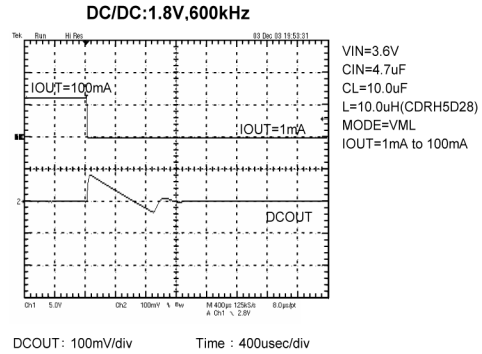
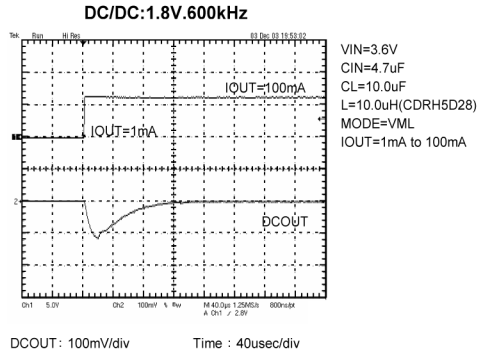

(b) PWM/PFM Automatic Switching Control* (*XC9510H/K/L Series Only)

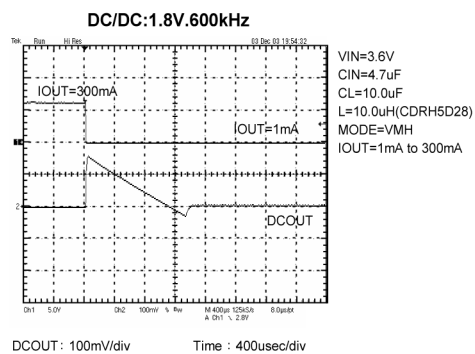
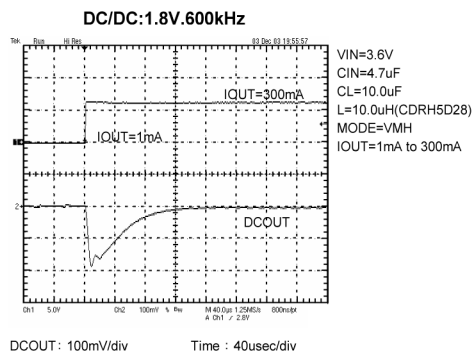
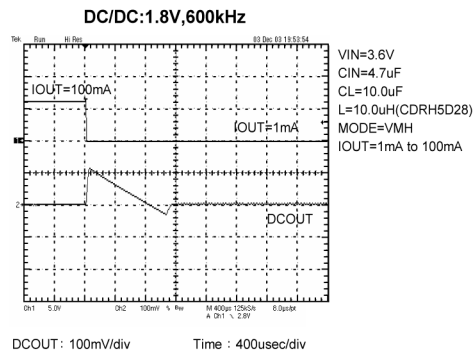
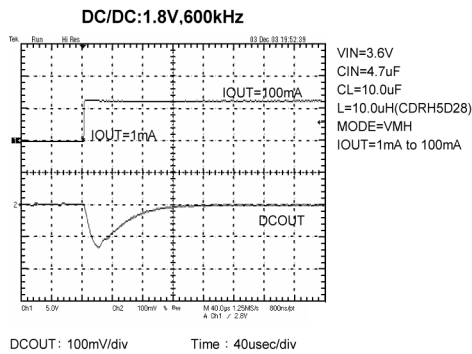

TYPICAL PERFORMANCE CHARACTERISTICS (Continued)

(A) DC/DC CONVERTER (Continued)

(10-4) DC/DC Load Transient Response (*DCOUT:3.3V FOSC:600kHz)

(a) PWM control

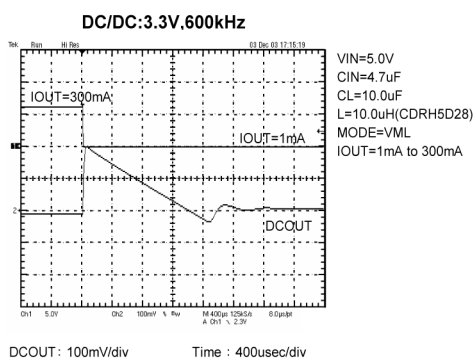
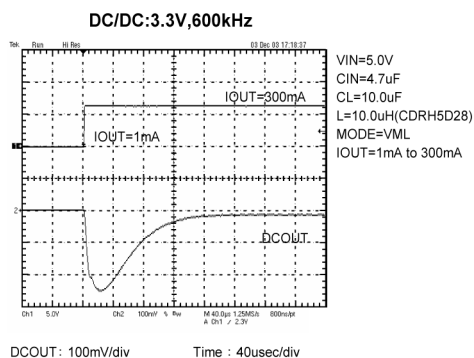
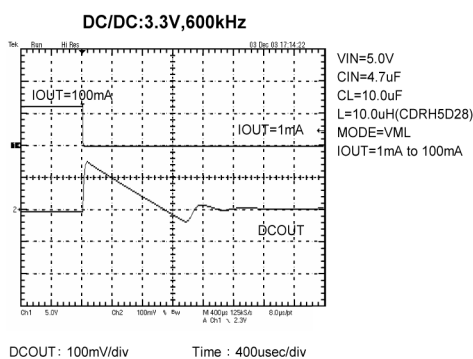
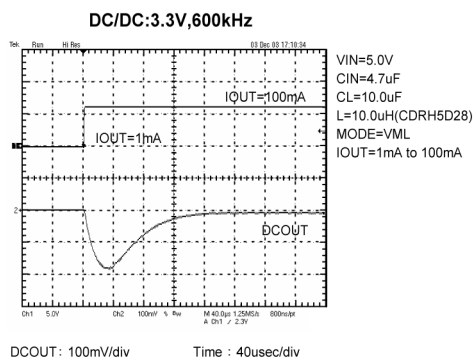

(b) PWM/PFM Automatic Switching Control* (*XC9510H/K/L Series Only)

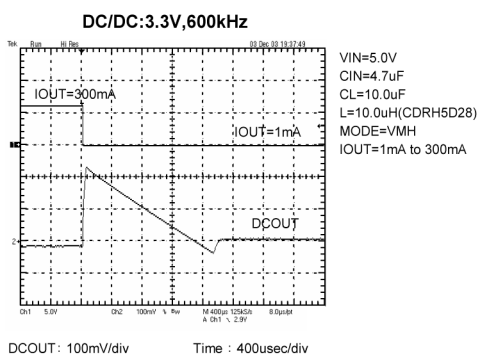
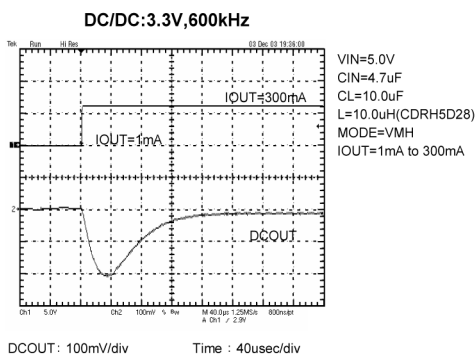
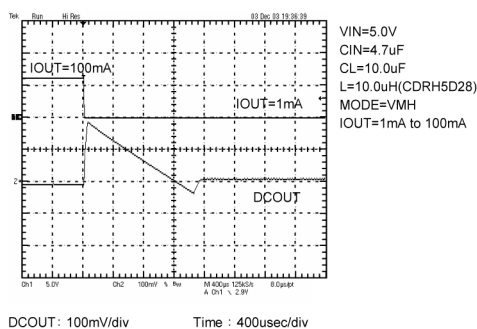
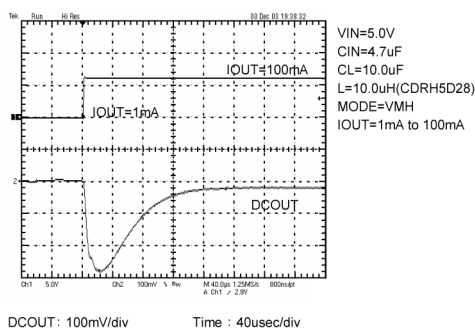

■ TYPICAL PERFORMANCE CHARACTERISTICS (Continued)

(B) VOLTAGE REGULATOR

(1) Output Voltage vs. Input Voltage

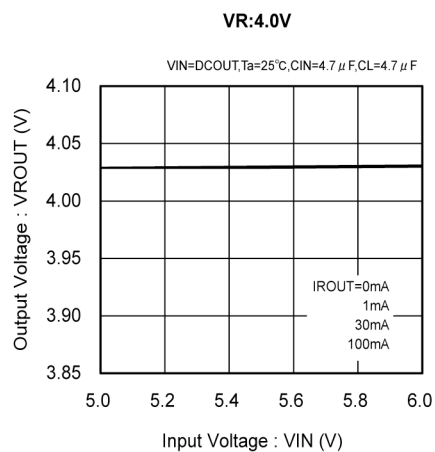
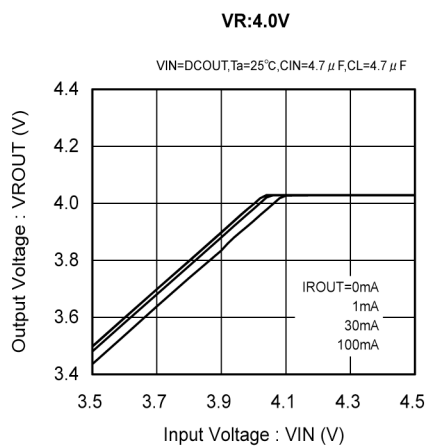
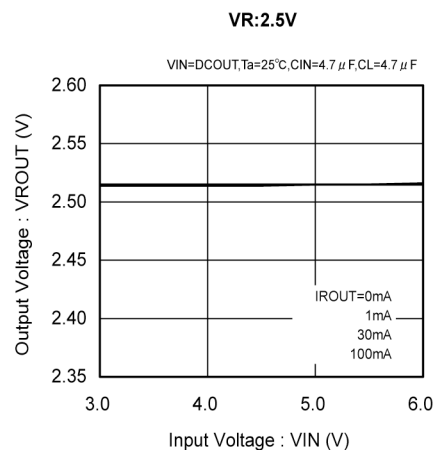
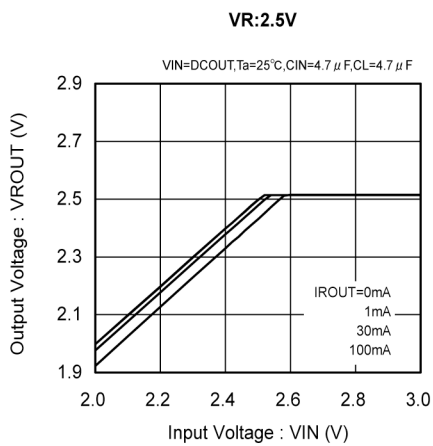
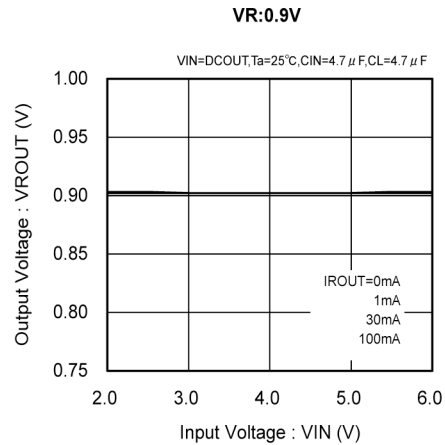
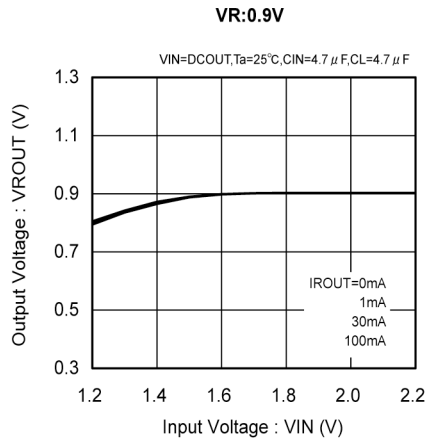

■ TYPICAL PERFORMANCE CHARACTERISTICS (Continued)

(B) VOLTAGE REGULATOR (Continued)

(2) Output Voltage vs. Output Current (Current Limit)

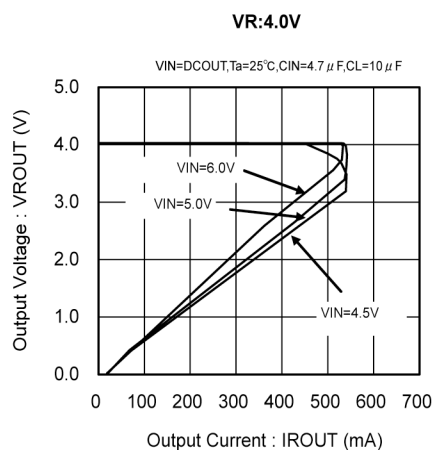
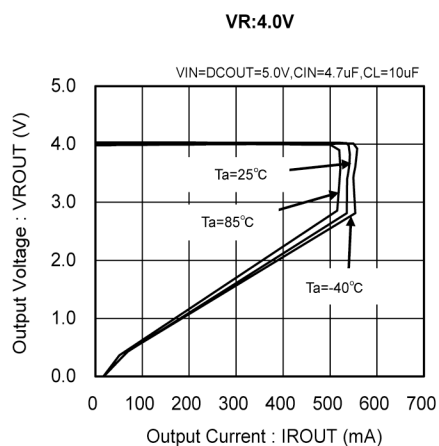
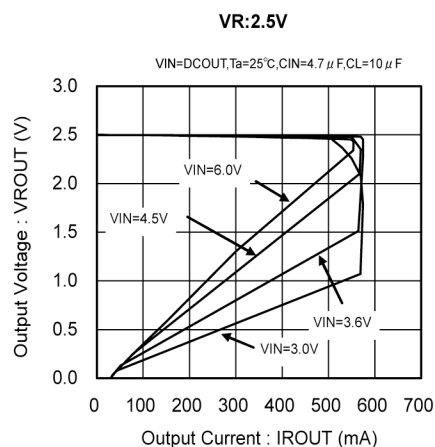
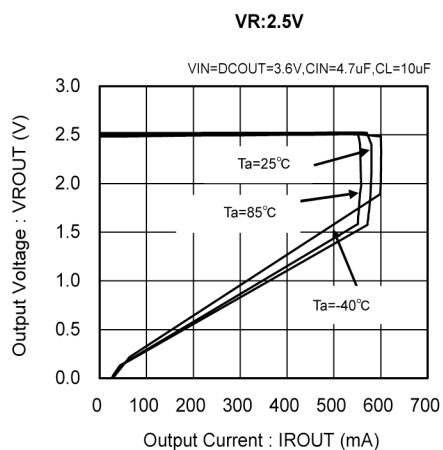
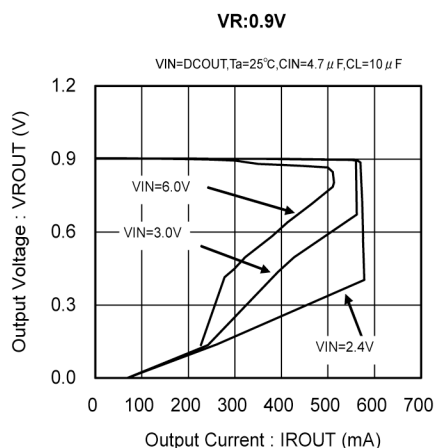
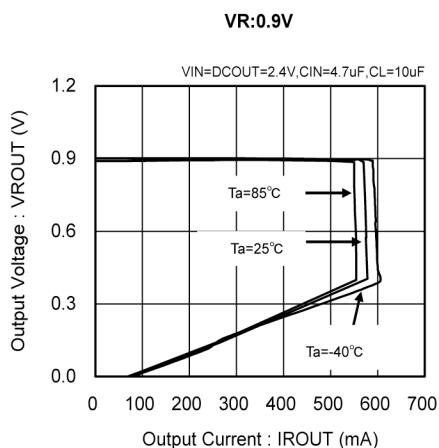

■ TYPICAL PERFORMANCE CHARACTERISTICS (Continued)

(B) VOLTAGE REGULATOR (Continued)

(3) Dropout Voltage vs. Output Current

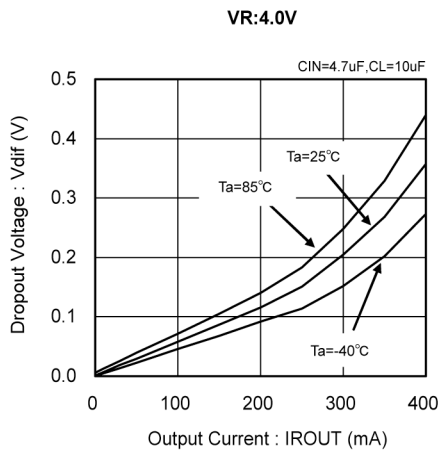
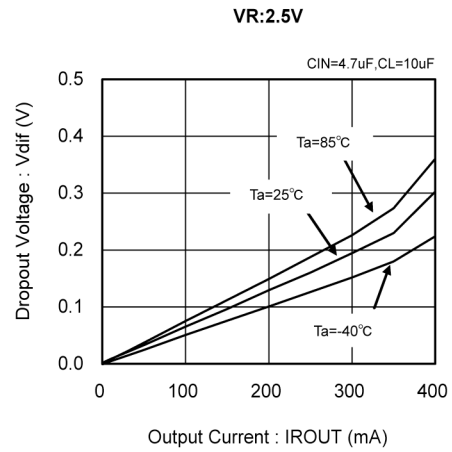
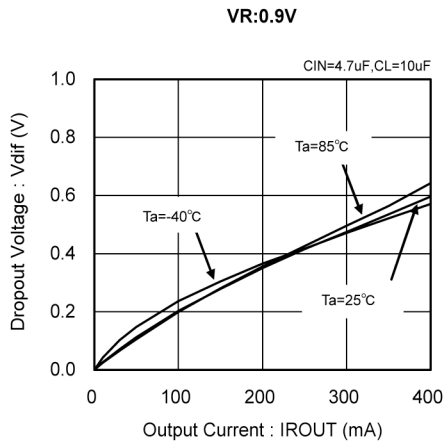

■ TYPICAL PERFORMANCE CHARACTERISTICS (Continued)

(B) VOLTAGE REGULATOR (Continued)

(4) Output Voltage vs. Output Current

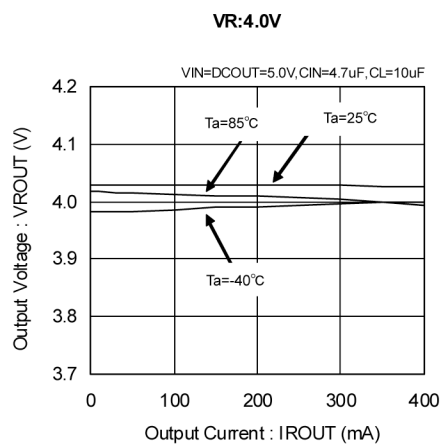
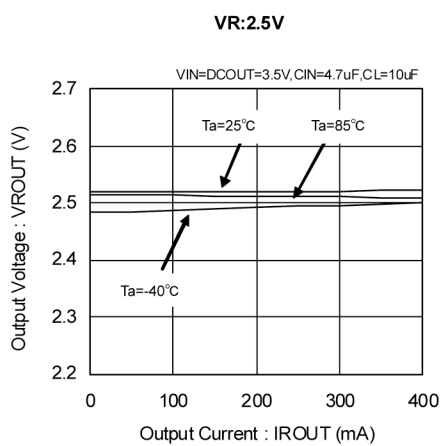
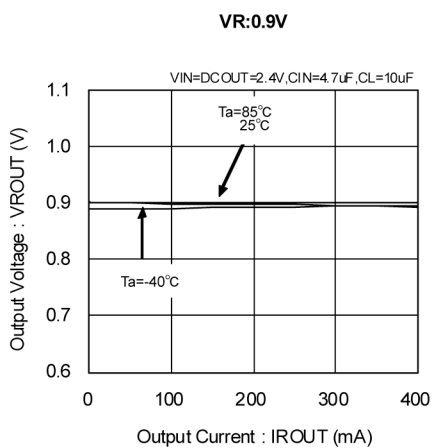

■ TYPICAL PERFORMANCE CHARACTERISTICS (Continued)

(B) VOLTAGE REGULATOR (Continued)

(5) Output Voltage vs. Ambient Temperature

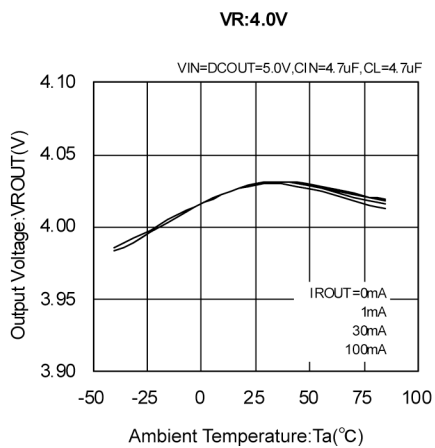
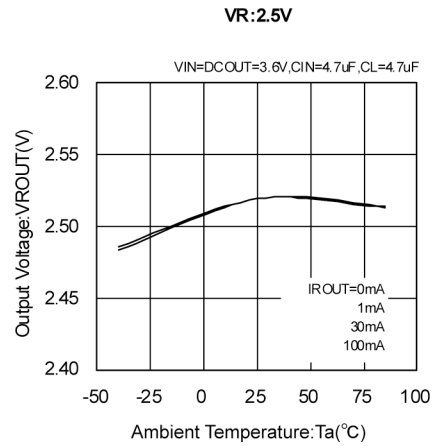
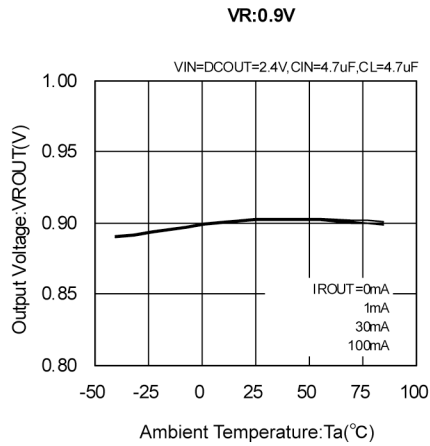

■ TYPICAL PERFORMANCE CHARACTERISTICS (Continued)

(B) VOLTAGE REGULATOR (Continued)

(6) Ripple Rejection Ratio vs. Ripple Frequency

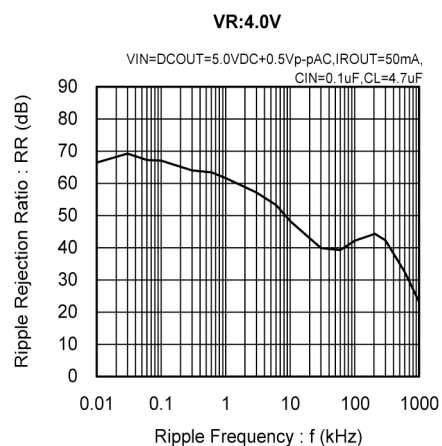
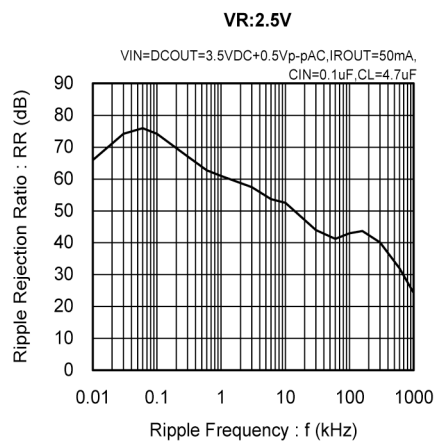
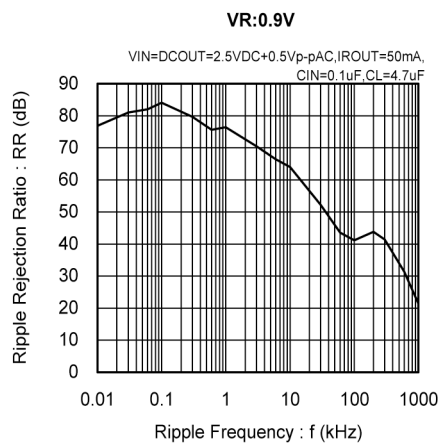

■ TYPICAL PERFORMANCE CHARACTERISTICS (Continued)

(B) VOLTAGE REGULATOR (Continued)

(7) VR LOAD TRANSIENT RESPONSE

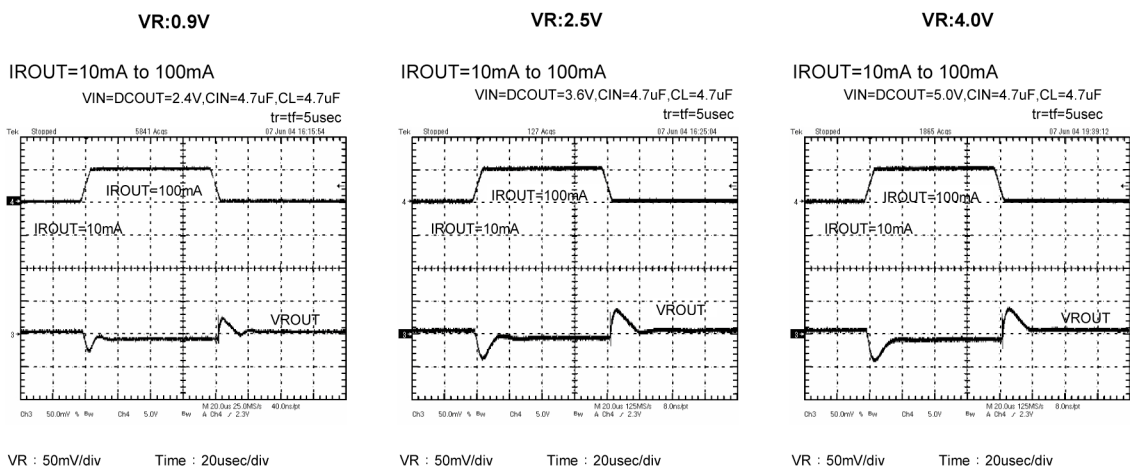
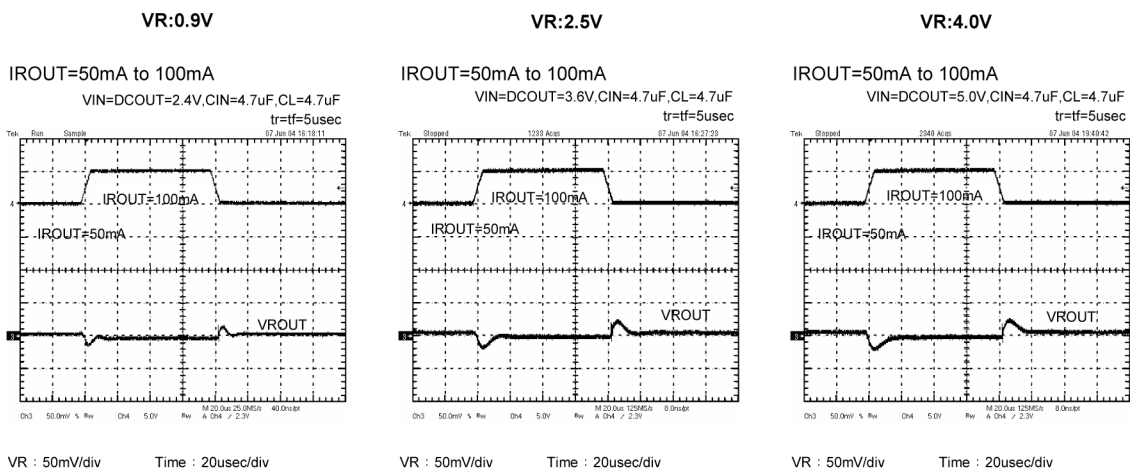
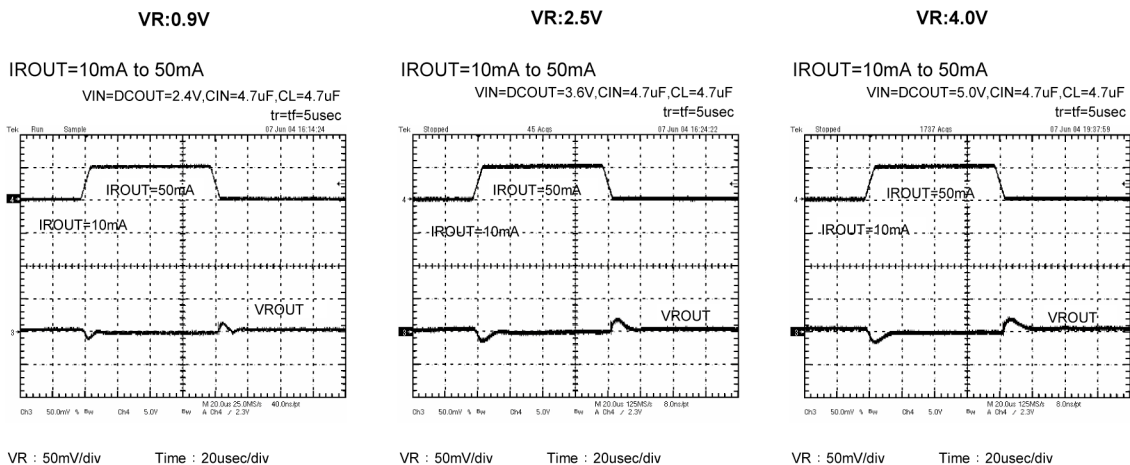

■ TYPICAL PERFORMANCE CHARACTERISTICS (Continued)

(C) VOLTAGE DETECTOR

(1) Output Current vs. Input Voltage

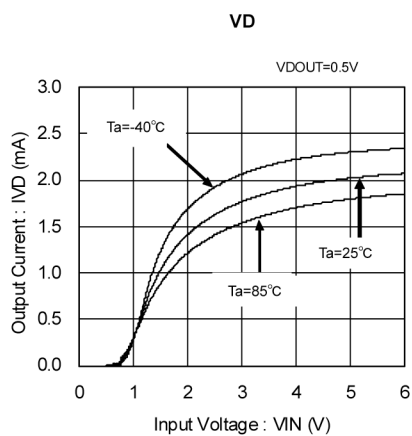

(2) Detect Voltage vs. Input Voltage

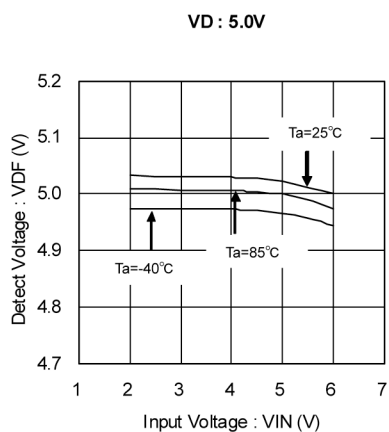
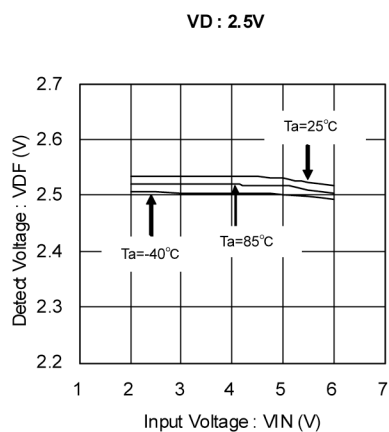
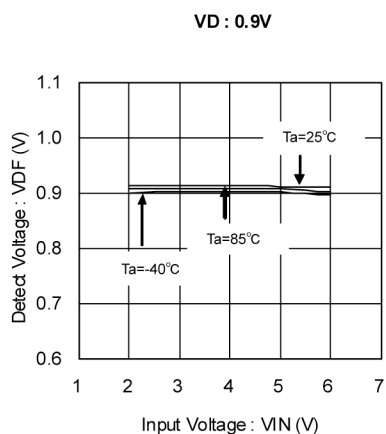

■ TYPICAL PERFORMANCE CHARACTERISTICS (Continued)

(C) VOLTAGE DETECTOR (Continued)

(3) Detect Voltage, Release Voltage vs. Ambient Temperature

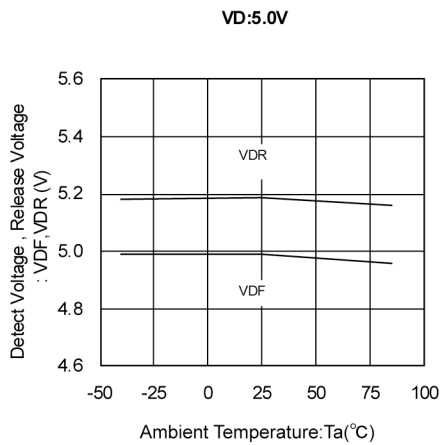
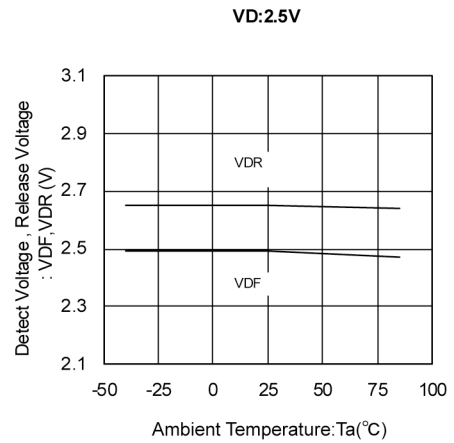
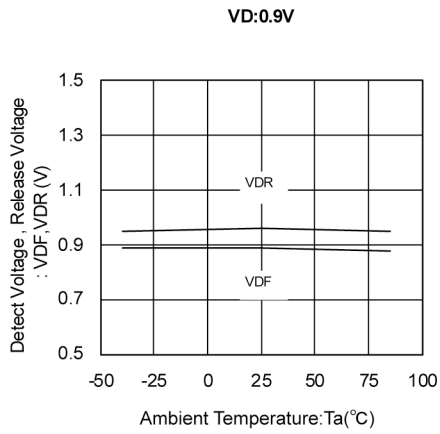

■ TYPICAL PERFORMANCE CHARACTERISTICS (Continued)

(D) COMMON

(1) Supply Current vs. Ambient Temperature (DC/DC & VR & VD)

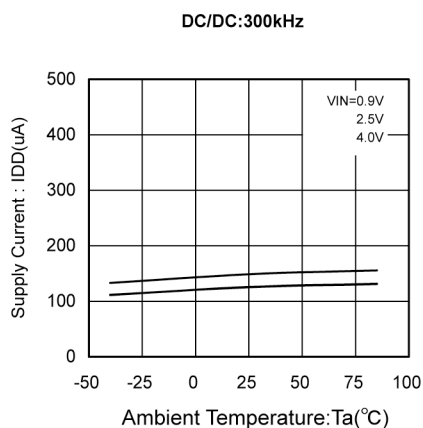
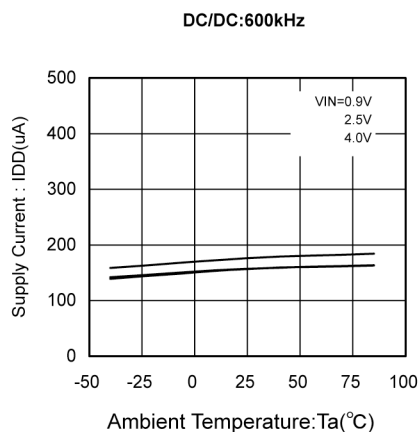
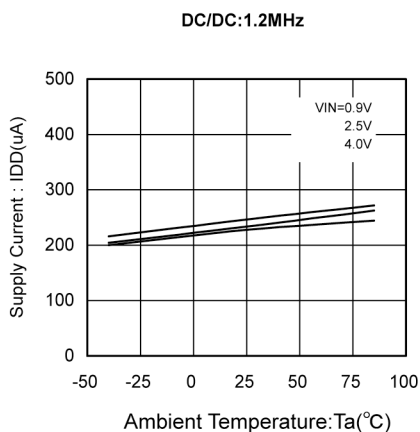

(2) Shutdown Current vs. Input Voltage

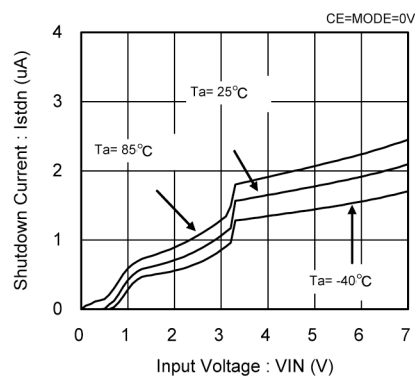

(3) Shutdown Current vs. Ambient Temperature

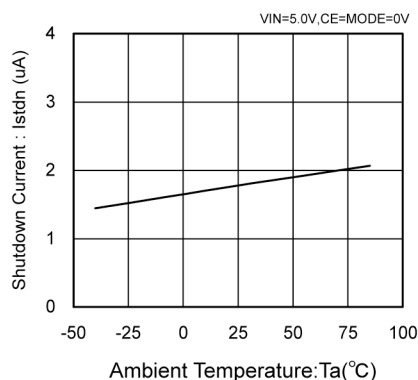

■ TYPICAL PERFORMANCE CHARACTERISTICS (Continued)

(D) COMMON (Continued)

(4) CE/MODE Pin Threshold Voltage*

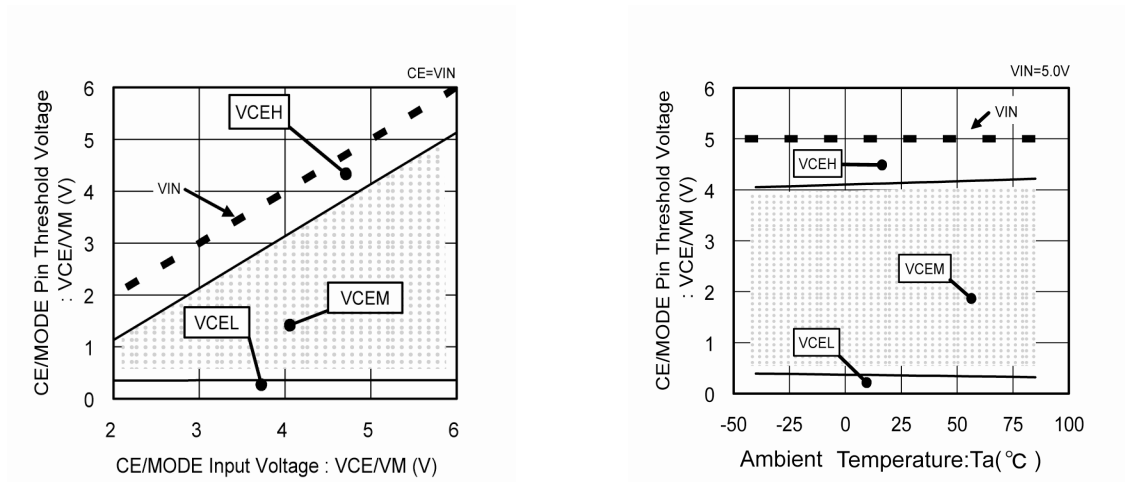

* Control Methods, CE/MODE Pin, VDSENSE Pin

SERIES	TYPE	DC/DC CONTROL METHODS	CE="VCEH" LEVEL	CE="VCEM" LEVEL	CE="VCEL" LEVEL	VD SENSE PIN
XC9510	A	PWM Control	-	-	DC/DC: OFF VR: OFF VD: ON	V _{DD}
	B					DC _{OUT}
	C					VR _{OUT}
	D					V _{DD}
	E					DC _{OUT}
	F					VR _{OUT}
H	PWM, PFM/PWM Manual Switch	PFM / PWM Automatic Switch	PWM Control	DC/DC: OFF VR: OFF VD: ON	V _{DD}	
K					DC _{OUT}	
L					VR _{OUT}	