

4850 N

# AC axial compact fan



## ebm-papst St. Georgen GmbH & Co. KG

Hermann-Papst-Straße 1

D-78112 St. Georgen

Phone +49 7724 81-0

Fax +49 7724 81-1309

info2@de.ebmpapst.com

www.ebmpapst.com

## Nominal data

Type	4850 N	
Phase		1~
Nominal voltage	VAC	230
Frequency	Hz	50
Speed	min <sup>-1</sup>	1800
Power input	W	10.0
Min. ambient temperature	°C	-10
Max. ambient temperature	°C	70
Air flow	m <sup>3</sup> /h	100
Sound power level	B	4.4
Sound pressure level	dB(A)	32

ml = max. load · me = max. efficiency · fa = running at free air · cs = customer specs · cu = customer unit  
Subject to alterations



## Technical features

<b>General description</b>	<p>AC voltage fan with external rotor shaded-pole motor. Protected from overload by impedance protection.</p> <p>Fan housing and fan impeller made of metal.</p> <p>Inlet over bars. Rotational direction clockwise looking at rotor. Types 4890 N and 4840 N air exhaust over bars.</p> <p>Electrical connection to 2 flat plugs 3.0 x 0.5 mm.</p> <p>Impeller with 3 or 5 blades, see note for fan type.</p> <p>Optionally available:</p> <p>variants with reinforced mounting flanges and single strands that are brought out.</p> <p>Fan housing with grounding lugs with M4 and UNC thread.</p> <p>Mass 550 g.</p> <p>Please note our new ACmaxx series. With identical fastening dimensions and voltages, this series achieves higher energy efficiency.</p>
<b>Mass</b>	0.550 kg
<b>Dimensions</b>	119 x 119 x 38 mm
<b>Material of impeller</b>	Metal
<b>Housing material</b>	Metal
<b>Direction of air flow</b>	Inlet over bars
<b>Direction of rotation</b>	Right, looking at rotor
<b>Bearing</b>	Sintec sleeve bearing system
<b>Lifetime L10 at 40 °C</b>	57500 h
<b>Lifetime L10 at maximum temperature</b>	27500 h
<b>Connection line</b>	2 flat plugs 3.0 x 0.5 mm. Housing with grounding lugs for screw M4 and UNC.
<b>Motor protection</b>	Protected from overload using impedance protection
<b>Approval</b>	VDE, CSA, UL, CE

## Product drawing

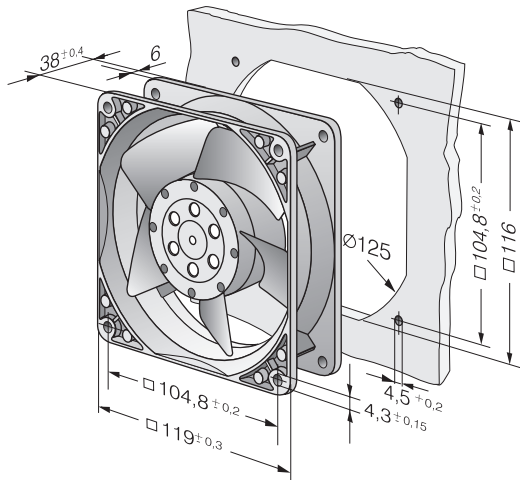

## Charts: Air flow

