



JEWEL HILL ELECTRONIC CO.,LTD.

SPECIFICATIONS FOR  
LCD MODULE

Model No.           **JH162A**          

Rm. 618,6/F., 501 Shangbu Industrial District, HuaqiangNorthRoad, Shenzhen, China

TEL: (86)-755-83362489 83246948      FAX: (86)-755-83246948

E-mail: [jhlcd@21cn.com](mailto:jhlcd@21cn.com) & [lcdzhou@public.szptt.net.cn](mailto:lcdzhou@public.szptt.net.cn)

# REVISION RECORD

Date	Ref. Page	Rev. No.	Revision Items	Prepared	Checked & Approved

## CONTENTS

1. General Specifications-----	1
- - - - -	
2. Mechanical Diagram-----	2
- - - - -	
3. LCD Module Number System-----	3
- - - - -	
4. Absolute Maximum Ratings-----	4
- - - - -	
5. Electrical Characteristics-----	4
- - - - -	
6. Interface Pin Function-----	5
- - - - -	
7. Circuit Block Diagram-----	6
- - - - -	
8. Interface Timing Chart-----	6
- - - - -	
9. Character Generator ROM Map-----	8
- - - - -	
10. Instruction Code-----	9
- - - - -	
11. Optical Characteristics-----	1 0
- - - - -	
12. Backlight Characteristics-----	1 2
- - - - -	
13. Reliability Test-----	1 3
- - - - -	
14. Quality Level-----	1 4
- - - - -	
15. Inspection specification-----	1 5
- - - - -	
16. Precautions for Use of LCD Modules-----	2 0
- - - - -	

## 1. General Specifications:

Display fonts: 16 X 2

Display type: STN

Display color: YELLOW-GREEN

Polarizer mode: TRANSFLECTIVE

View angle: 6 O'CLOCK

Driving method: 1/16 DUTY , 1/5 BIAS

Backlight: LED

Data transfer: 8 / 4 BIT PARALLEL

Operating temperature: -10 -- 60

Storage temperature: -20 -- 70

Dot matrix: 16 CHARACTER X 2 LINES

Dot size: 0.55 X 0.5 mm

Dot pitch: 0.6 X 0.55 mm

Assy. Type: COB

Weight:

2. Mechanical diagram:

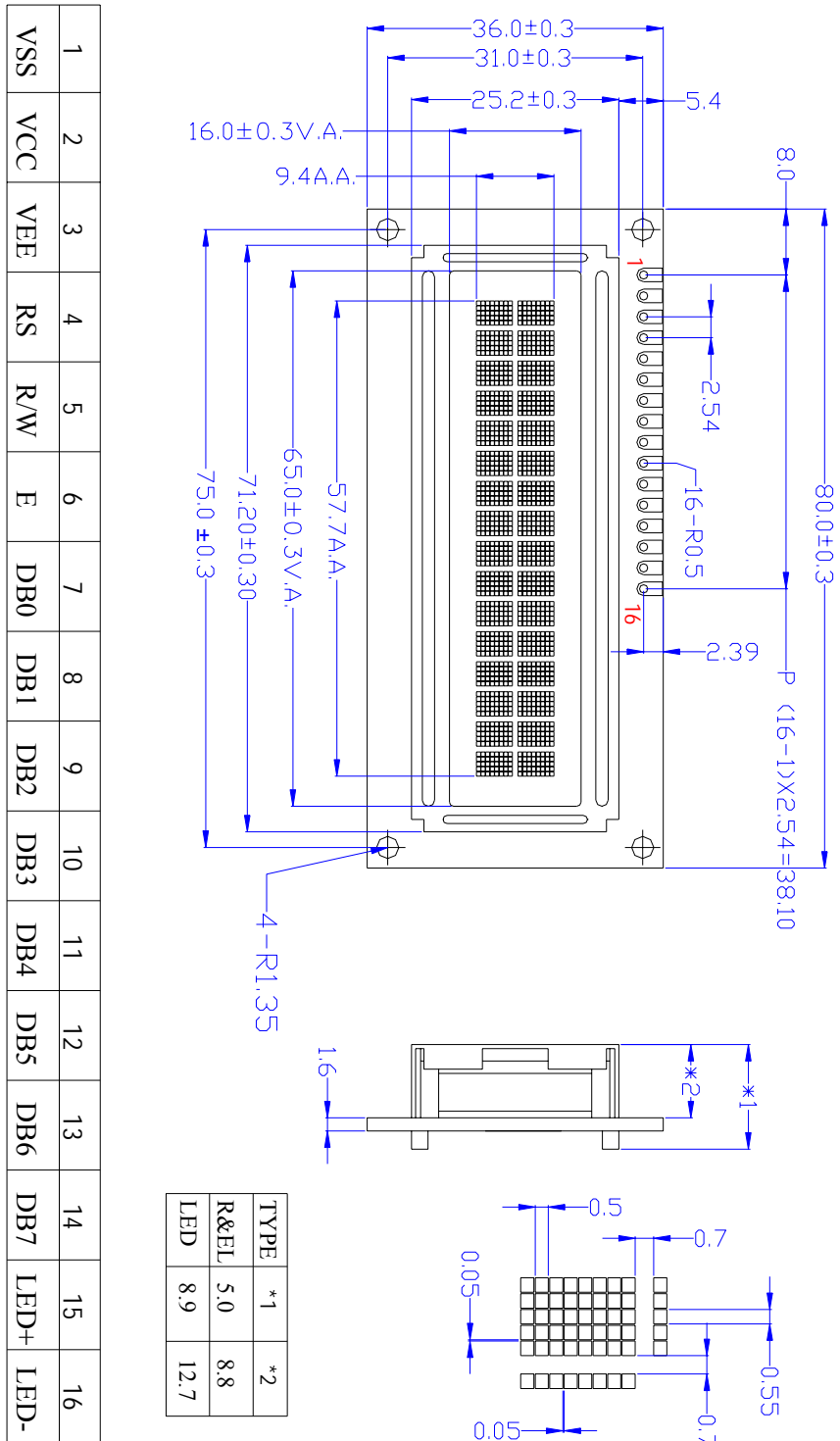
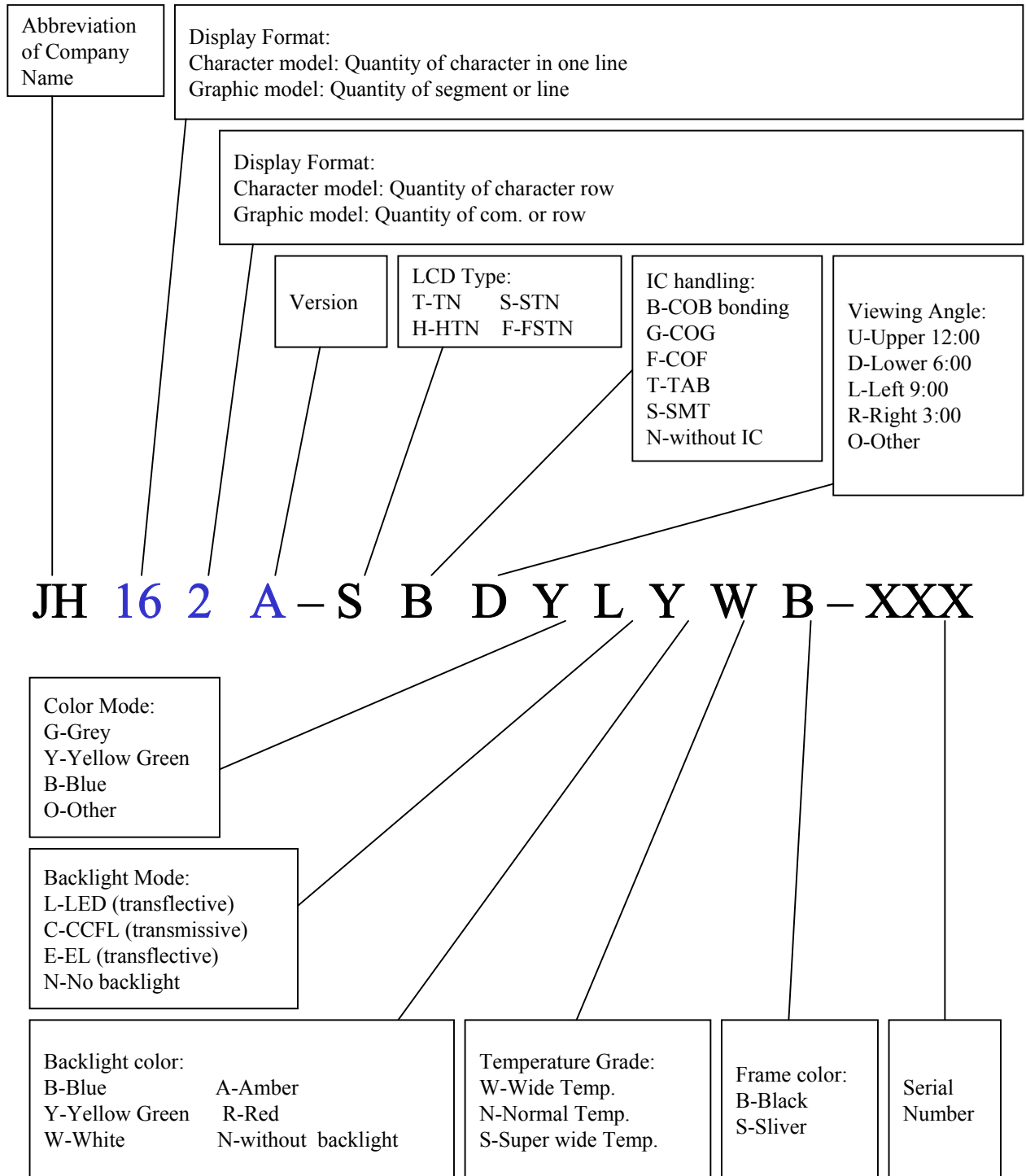

Fig 1

### 3. LCD Module Number System:



#### 4. Absolute Maximum Ratings:

Item	Symbol	Min.	Max.	Unit	Remark
Power Supply Voltage	$V_{DD}-V_{SS}$	-0.3	7.0	V	
LCD Driving Voltage	$V_{LCD}$	-0.3	13.0	V	
Operating Temperature Range	$T_{OP}$	-0	+0		No Condensation
Storage Temperature Range	$T_{ST}$	-20	+70		No Condensation

#### 5. Electrical Characteristics:

( $V_{DD}=5.0V \pm 10\%$ ,  $V_{SS}=0V$ ,  $T_a=25$  )

Item	Symbol	Min.	Typ.	Max.	Unit
Supply voltage(Logic)	$V_{DD}-V_{SS}$	4.5	5.0	5.5	V
Input high voltage (LCD Drive)	$V_{LCD}$	--	4.7	--	V
Input Signal Voltage	High $V_{IH}$ ( $V_{DD} = 5.0$ )	$0.7 V_{DD}$	--	$V_{DD} + 0.3$	V
	Low $V_{IL}$ ( $V_{DD} = 5.0$ )	-0.3	--	$0.2 V_{DD}$	V
Supply current (Logic)	$I_{DD}$ ( $V_{DD}-V_{SS} = 5.0$ )	--	1.5	--	mA
Supply current (LCD Drive)	$I_{EE}$	--	0.4	--	mA
Supply current (LED Drive)	$I_{LED}$	--	--	157.4	mA

**6. Interface Pin Function:**

Pin No.:	Symbol	Level	Description
1	V <sub>SS</sub>	0V	Ground
2	V <sub>CC</sub>	5.0V	Power supply voltage for logic and LCD(+)
3	V <sub>EE</sub>	0.3V	Power supply voltage LCD(-)
4	RS	H/L	Selects registers(H: Data L: Instruction)
5	R/W	H/L	Selects read or write
6	E	H/L	Starts data read/write
7	DB0	H/L	Data bit0
8	DB1	H/L	Data bit1
9	DB2	H/L	Data bit2
10	DB3	H/L	Data bit3
11	DB4	H/L	Data bit4
12	DB5	H/L	Data bit5
13	DB6	H/L	Data bit6
14	DB7	H/L	Data bit7
15	BL+	4.2 V	Back light power supply voltage( + )
16	BL-	0 V	Back light power supply voltage( - )



7. Circuit Block Diagram:

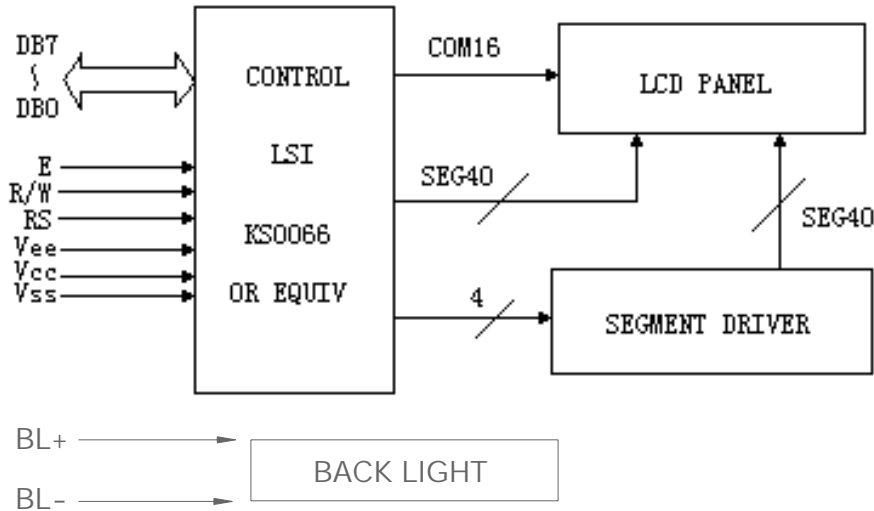

Fig 2

8. Interface Timing Chart

AC Characteristics ( $V_{DD}=4.5V\sim 5.5V$ ,  $T_a=-30 \sim +85$  )

Mode	Characteristic	Symbol	Min.	Typ.	Max.	Unit
Write Mode (Refer to fig 3)	E Cycle Time	$t_C$	500	-	-	ns
	E Rise / Fall Time	$t_R, t_F$	-	-	20	
	E Pulse Width ( High, Low)	$t_W$	230	-	-	
	R/W and RS Setup Time	$t_{SU1}$	40	-	-	
	R/W and RS Hold Time	$t_{H1}$	10	-	-	
	Data Setup Time	$t_{SU2}$	80	-	-	
	Data Hold Time	$t_{H2}$	10	-	-	
Read Mode (Refer to fig 4)	E Cycle Time	$t_C$	500	-	-	ns
	E Rise / Fall Time	$t_R, t_F$	-	-	20	
	E Pulse Width ( High, Low)	$t_W$	230	-	-	
	R/W and RS Setup Time	$t_{SU}$	40	-	-	
	R/W and RS Hold Time	$t_H$	10	-	-	
	Data Output Delay Time	$t_D$	-	-	120	
	Data Hold Time	$t_{DH}$	5	-	-	

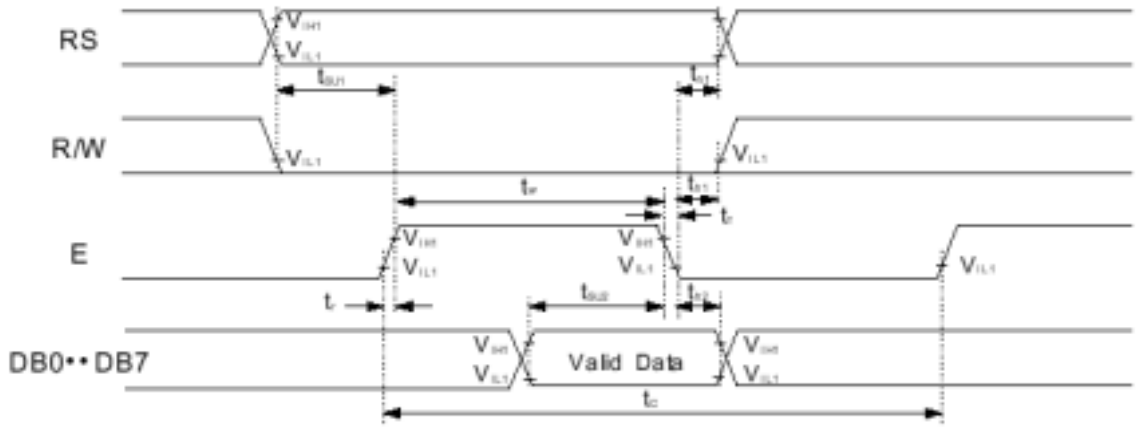

Fig 3: Write Mode

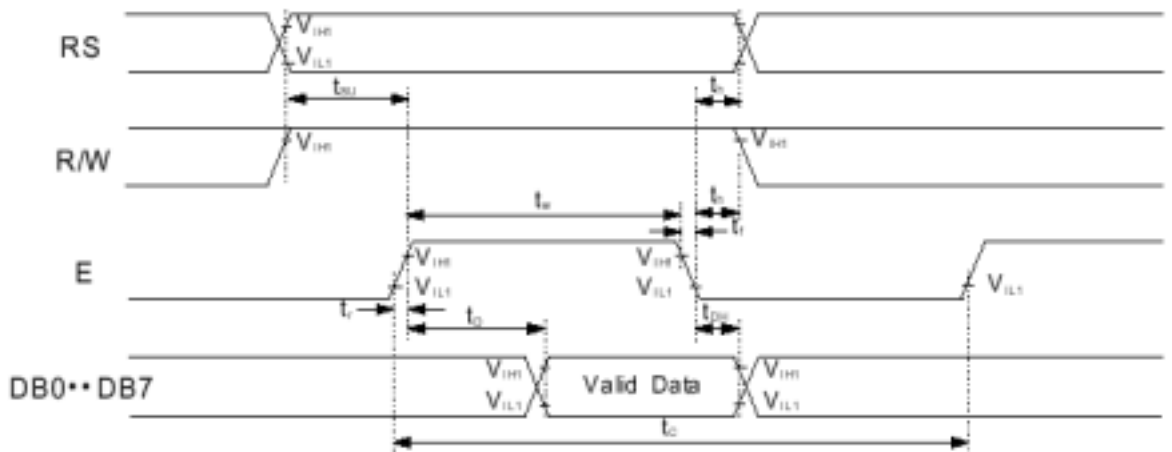

Fig 4: Read Mode

9. Character Generator ROM Map:

HIGHER 4BIT LOWER 4BIT	MSB 0000	0010	0011	0100	0101	0110	0111	1000	1001	1010	1011	1100	1101	1110	1111
LSB XXXX0000	CG RAM (1)		0	a	P	`	P			-	9	ε	α	ρ	
XXXX0001	(2)	!	1	A	Q	a	9			μ	7	4	ä	q	
XXXX0010	(3)	"	2	B	R	b	r			Γ	ι	υ	×	ρ	θ
XXXX0011	(4)	#	3	C	S	c	s			∩	ウ	テ	ε	ε	ω
XXXX0100	(5)	\$	4	D	T	d	t			√	ι	ト	ト	μ	Ω
XXXX0101	(6)	%	5	E	U	e	u			•	オ	ナ	1	ε	ü
XXXX0110	(7)	&	6	F	V	f	v			ヲ	カ	ニ	ヨ	ρ	Σ
XXXX0111	(8)	'	7	G	W	g	w			フ	チ	ヌ	ラ	g	π
XXXX1000	(1)	(	8	H	X	h	x			イ	ウ	ホ	リ	フ	又
XXXX1001	(2)	)	9	I	Y	i	y			ウ	ケ	ル	ル	'	γ
XXXX1010	(3)	*	:	J	Z	j	z			エ	コ	ハ	レ	j	〒
XXXX1011	(4)	+	;	K	[	k	[			オ	サ	ヒ	ロ	×	ア
XXXX1100	(5)	,	<	L	¥	l	l			カ	シ	フ	フ	φ	ア
XXXX1101	(6)	-	=	M	]	m	]			ユ	ズ	ハ	レ	÷	
XXXX1110	(7)	.	>	N	^	n	→			ヨ	セ	ホ	°	ñ	
XXXX1111	(8)	/	?	O	_	o	←			ウ	ソ	マ	°	ö	■

10. Instruction Code:

Instruction	Code										Description	E-Cycle f <sub>osc</sub> =270kHz
	RS	R/W	DB7	DB6	DB5	DB4	DB3	DB2	DB1	DB0		
Clear Display	0	0	0	0	0	0	0	0	0	1	Write "20H" to DDRAM and set DDRAM to "00H" from AC	1.53ms
Return Home	0	0	0	0	0	0	0	0	1	-	Set DDRAM address to "00H" from AC and return cursor to its original position if shifted. The contents of DDRAM are not changed.	1.53ms
Entry Mode	0	0	0	0	0	0	0	1	I/D	S/H	Assign cursor moving direction and enable the shift of entire display	39μs
Display ON/OFF Control	0	0	0	0	0	0	1	D	C	B	Set display(D), cursor(C), and blinking of cursor(B) on/off control bit	39μs
Cursor or Display Shift	0	0	0	0	0	1	S/C	R/L	-	-	Set cursor moving and display shift control bit, and the direction, without changing of DDRAM data	39μs
Function Set	0	0	0	0	1	D	N	F	-	-	Set interface data length(DL), numbers of display line(N: 2-line/1-line) and, display font type(F:5*11/5*8)	39μs
Set CGRAM Address	0	0	0	1	AC5	AC4	AC3	AC2	AC1	AC0	Set CGRAM address in address counter(AC)	39μs
Set DDRAM Address	0	0	1	AC6	AC5	AC4	AC3	AC2	AC1	AC0	Set DDRAM address in address counter(AC)	39μs
Read Busy Flag and Address	0	1	BF	AC6	AC5	AC4	AC3	AC2	AC1	AC0	Whether during internal operation or not can be known by reading BF. The contents of address counter can also be read	0μs
Write Data to RAM	1	0	D7	D6	D5	D4	D3	D2	D1	D0	Write data into internal RAM(DDRAM/CGRAM)	43μs
Read Data from Ram	1	1	D7	D6	D5	D4	D3	D2	D1	D0	Read data from internal RAM(DDRAM/CGRAM)	43μs

**NOTE:** When an MPU program with checking the Busy Flag(DB7) is made, it must be necessary 1/2Fosc for executing the next instruction by the falling edge of the 'E' signal after the Busy Flag (DB7) goes to "Low"

## 11. Optical Characteristics

### A. Optical Characteristics

Ta = 25

Item	Symbol	Condition	Min.	Typ.	Max.	Unit
Viewing Angle	x	Cr 2	y=0 °	-35 -- 20		Deg
	y					
Contrast Ratio	Cr	x=0 ° y=0 °	4.0	-	-	
Response Time	Turn on	y=0 ° x=0	-	-	250	ms
	Turn off		T <sub>off</sub>	-	-	

### B. Definition of Optical Characteristics

#### a. Definition of Viewing Angle

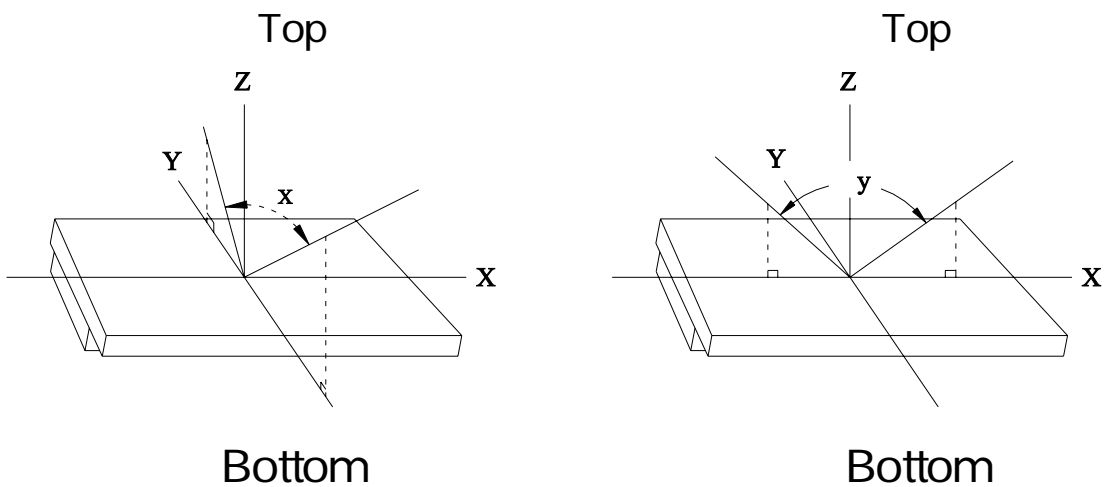

Fig 5

**b. Definition of Contrast Ratio**

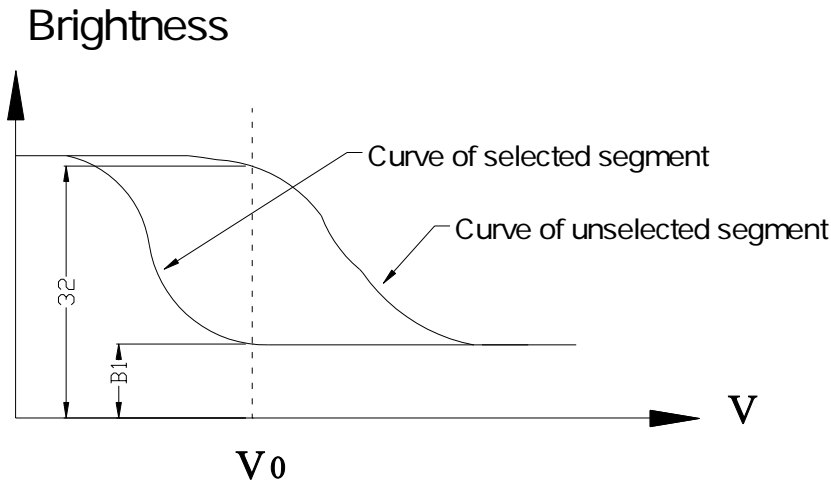

Fig 6

$$\text{Contrast Ratio} = B_2/B_1 = \frac{\text{selected state brightness}}{\text{selected state brightness}}$$

Measuring Conditions:

- 1) Ambient Temperature: 25
- 2) Frame frequency: 64Hz

**c. Definition of Response time**

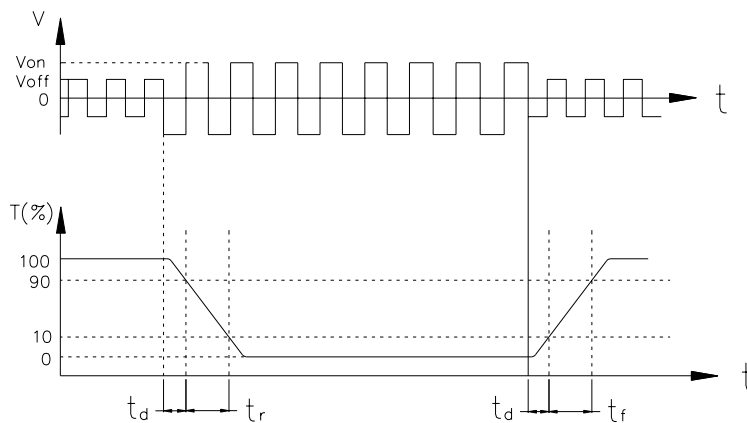

Fig 7

Turn on time:  $t_{on} = t_d + t_r$

Turn off time:  $t_{off} = t_d + t_f$

Measuring Conditions:

- 1) Operating Voltage: 4.7 V
- 2) Frame frequency: 64Hz

## 12. Backlight Characteristics:

### LED Backlight

#### i) Feature

- Long life expectancy of >100,000 hours.
- Simple brightness adjustment.
- This is the most popular choice of backlight.

#### ii) Electrical and optical data

			Per Segment			Unit	Condition
			Min.	Typ.	Max.		
Forward Voltage		$V_F$	3.8	4.2	4.5	V	$I_F=10MA$
Reverse Current		$I_R$	--	--	100	$\mu A$	$V_R=4VA$
Peak Wavelength	Green	P	--	565	--	nm	$I_F=10MA$
	Yellow		--	585	--		
	Red		--	635	--		

#### iii) Maximum ratings at 25

Each LED segment consists of 2 LED chips in series

	Symbol	Maximum Value
Forward Current	$I_F$	15MA
Pulse Current, 10% duty, 1ms pulse width	$I_{FP}$	50MA
Reverse Voltage	$V_R$	4.0V
Power Dissipation	P	45MVV
Operating Temperature	$T_{OP}$	-20 -----+70
Storage Temperature	$T_{ST}$	-30 -----+80

### 13. Reliability Test:

#### a. Content of Reliability Test

No.	Test Item	Content of Test	Test Condition
1	High Temperature Storage	Endurance test applying the high storage temperature for a long time	70 96H
2	Low Temperature Storage	Endurance test applying the low storage temperature for a long time	-20 96H
3	High Temperature Operation	Endurance test applying the electric stress (voltage & current) and the thermal stress to the element for a long time	60 96H
4	Low Temperature Operation	Endurance test applying the electric stress under low temperature for a long time	-10 96H
5	High Temperature / Humidity Storage	Endurance test applying the high temperature and high humidity storage for a long time	40 / 90%RH 96H
6	Temperature Cycle	Endurance test applying the low and high temperature cycle -20    25    60    25 30min 5min 30min 5min ----- 1 Cycle	-20 / 60 10 cycles
7	Vibration Test (package state)	Endurance test applying the vibration during transportation	10Hz~150Hz 50m/s <sup>2</sup> 40min
8	Shock Test (package state)	Endurance test applying the shock during transportation	Half-sine wave 100m/s <sup>2</sup> 11ms
9	Atmospheric Pressure Test	Endurance test applying the atmospheric pressure during transportation by air	40 kPa 16H



b. Failure Judgment Criterion

Criterion Item	Test Item No.									Failure Judgment Criterion
	1	2	3	4	5	6	7	8	9	
Basic Specification	√	√	√	√	√	√	√	√	√	Out of the basic specification
Electrical Specification	√	√	√	√	√					Out of the electrical specification
Mechanical Specification							√	√		Out of the mechanical specification
Optical Characteristic	√	√	√	√	√	√			√	Out of the optical specification
Note	For test item refer to 13-a									
Remark	Basic specification = Optical specification + Mechanical specification									



14. Quality Level:

Examination or Test	At Ta=25 (unless otherwise stated)	Inspection				
		Min.	Max.	Unit	IL	AQL
External Visual Inspection	Under normal illumination and eyesight condition, the distance between eyes and LCD is 25cm.	See Inspection A			II	Major 1.0 Minor 2.5
Display Defects	Under normal illumination and eyesight condition, display on inspection.	See Inspection B			II	Major 1.0 Minor 2.5
Note: Major defects: Open segment or common, Short, Serious damages, Leakage Minor defects: Others Sampling standard conforms to GB2828						

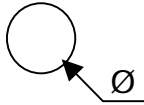
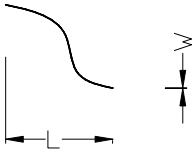
15. Inspection specification

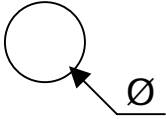
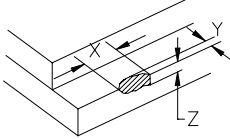
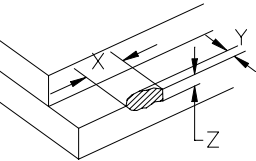
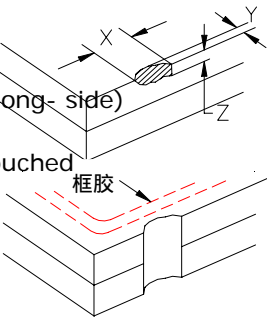
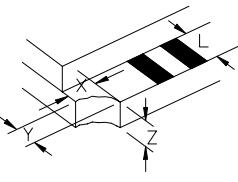
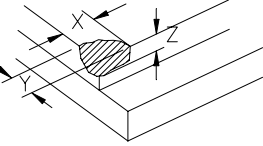
NO	Item	Criterion	AQL											
01	Electrical Testing	1.1 Missing vertical, horizontal segment, segment contrast defect. 1.2 Missing character, dot or icon. 1.3 Display malfunction. 1.4 No function or no display. 1.5 Current consumption exceeds product specifications. 1.6 LCD viewing angle defect. 1.7 Mixed product types. 1.8 Contrast defect.	1.0											
02	Black or white Spots on LCD (display only)	2.1 White and black spots on display $\leq 0.25\text{mm}$ , no more than three white or black spots present. 2.2 Densely spaced: No more than two spots or lines within 3mm	2.5											
03	LCD black spots, white spots.	3.1 Round type: As following drawing  <table border="1" data-bbox="678 1145 1160 1353"> <thead> <tr> <th>Positive mode</th> <th>ACC qty.</th> </tr> </thead> <tbody> <tr> <td><math>\varnothing &lt; 0.2\text{mm}</math></td> <td>Ignoring</td> </tr> <tr> <td><math>0.2\text{mm} \leq \varnothing \leq 0.5\text{mm}</math></td> <td>3</td> </tr> <tr> <td><math>\varnothing &gt; 0.5\text{mm}</math></td> <td>0</td> </tr> </tbody> </table>	Positive mode	ACC qty.	$\varnothing < 0.2\text{mm}$	Ignoring	$0.2\text{mm} \leq \varnothing \leq 0.5\text{mm}$	3	$\varnothing > 0.5\text{mm}$	0	2.5			
	Positive mode	ACC qty.												
$\varnothing < 0.2\text{mm}$	Ignoring													
$0.2\text{mm} \leq \varnothing \leq 0.5\text{mm}$	3													
$\varnothing > 0.5\text{mm}$	0													
Contamination (non-display)	3.2 Line type: (As following drawing)  <table border="1" data-bbox="694 1450 1176 1711"> <thead> <tr> <th>Length</th> <th>Width</th> <th>ACC qty.</th> </tr> </thead> <tbody> <tr> <td><math>\leq 25\text{mm}</math></td> <td><math>\leq 0.02\text{mm}</math></td> <td>Ignoring</td> </tr> <tr> <td><math>\leq 25\text{mm}</math></td> <td><math>&gt; 0.02\text{mm}</math> <math>\leq 0.05\text{mm}</math></td> <td>3</td> </tr> <tr> <td><math>\geq 25\text{mm}</math></td> <td><math>&gt; 0.05\text{mm}</math></td> <td>0</td> </tr> </tbody> </table>	Length	Width	ACC qty.	$\leq 25\text{mm}$	$\leq 0.02\text{mm}$	Ignoring	$\leq 25\text{mm}$	$> 0.02\text{mm}$ $\leq 0.05\text{mm}$	3	$\geq 25\text{mm}$	$> 0.05\text{mm}$	0	2.5
Length	Width	ACC qty.												
$\leq 25\text{mm}$	$\leq 0.02\text{mm}$	Ignoring												
$\leq 25\text{mm}$	$> 0.02\text{mm}$ $\leq 0.05\text{mm}$	3												
$\geq 25\text{mm}$	$> 0.05\text{mm}$	0												

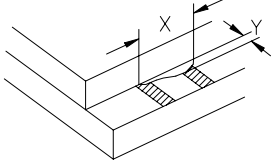
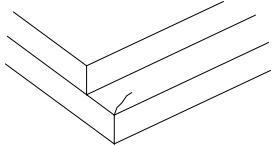
NO	ITEM	CRITERIA	AQL								
04	Polarizer bubbles	 <table border="1" data-bbox="711 410 1193 623"> <thead> <tr> <th>Positive mode</th> <th>ACC qty.</th> </tr> </thead> <tbody> <tr> <td><math>\varnothing &lt; 0.3\text{mm}</math></td> <td>Ignoring</td> </tr> <tr> <td><math>0.3\text{mm} \leq \varnothing \leq 0.5\text{mm}</math></td> <td>3</td> </tr> <tr> <td><math>\varnothing &gt; 0.5\text{mm}</math></td> <td>0</td> </tr> </tbody> </table>	Positive mode	ACC qty.	$\varnothing < 0.3\text{mm}$	Ignoring	$0.3\text{mm} \leq \varnothing \leq 0.5\text{mm}$	3	$\varnothing > 0.5\text{mm}$	0	2.5
Positive mode	ACC qty.										
$\varnothing < 0.3\text{mm}$	Ignoring										
$0.3\text{mm} \leq \varnothing \leq 0.5\text{mm}$	3										
$\varnothing > 0.5\text{mm}$	0										
05	Scratches	Follow NO.3 LCD black spots, white spots, contamination	2.5								
06	Chipped glass	 <p>1. <math>x \leq 1/8(\text{Length of the long-side})</math> 2. <math>y \leq 1/2 \text{ Pin Width}</math> 3. <math>z \leq 0.5\text{mm}</math></p>  <p>1. <math>x \leq 1/8 \text{ Length of the long-side}</math> 2. <math>y \leq 1/3L</math> ( L: Width of the long-side) 3. <math>z \leq 0.5\text{mm}</math></p>  <p>1. <math>x \leq 1/8(\text{Length of the long-side})</math> 2. The adhesive is untouched 3. Ignoring Z</p>  <p>1. <math>x \leq 1/8(\text{Length of the long-side})</math> (x without touching the long-side) 2. <math>y \leq 3/4 \text{ Pin width}</math> 3. Ignoring Z</p>  <p>1. <math>x \leq 1/8(\text{Length of the long-side})</math> 2. The adhesive is untouched 3. Ignoring Z</p>	2.5								

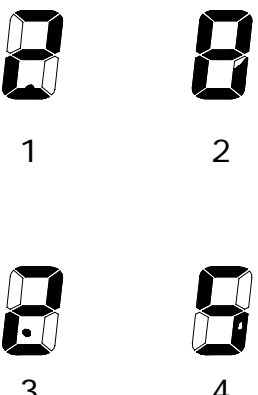
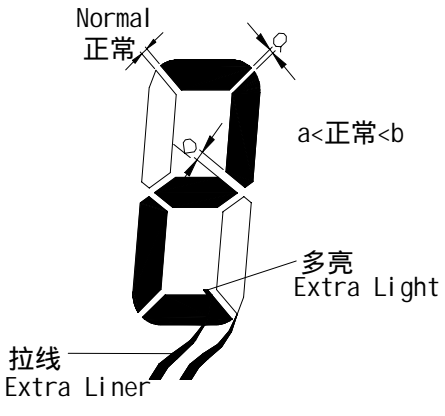
No	Item	Criterion	AQL								
06	Glass Crack	 <p>1. x Ignoring the length 2. y &gt; 1/3 Width of</p>	2.5								
		 <p>Any crack</p>	2.5								
07	Contrast ratio uneven	 <p>Pale(in viewing angle ) Under viewing angle</p>	2.5								
		 <p>Display “2” (in viewing angle or crosswalk)</p>	2.5								
08	Spot	 <p>1. Extra light 2. Partial segment missing 3. Light spot 4. Black spot</p> <table border="1" data-bbox="853 1191 1192 1398"> <thead> <tr> <th>Positive mode</th> <th>ACC qty.</th> </tr> </thead> <tbody> <tr> <td><math>\varnothing &lt; 0.1\text{mm}</math></td> <td>Ignoring</td> </tr> <tr> <td><math>0.1\text{mm} &lt; \varnothing &lt; 0.2\text{mm}</math></td> <td>3</td> </tr> <tr> <td><math>\varnothing &gt; 0.2\text{mm}</math></td> <td>0</td> </tr> </tbody> </table>	Positive mode	ACC qty.	$\varnothing < 0.1\text{mm}$	Ignoring	$0.1\text{mm} < \varnothing < 0.2\text{mm}$	3	$\varnothing > 0.2\text{mm}$	0	2.5
Positive mode	ACC qty.										
$\varnothing < 0.1\text{mm}$	Ignoring										
$0.1\text{mm} < \varnothing < 0.2\text{mm}$	3										
$\varnothing > 0.2\text{mm}$	0										
09	Segment deformation	 <p>1. Extra liner REJ 2. <math>b-a &gt; 0.2\text{mm}</math> <math>a/b \leq 4/5\text{mm}</math> REJ 3. <math>\varnothing \leq 0.2\text{mm}</math> Up to 3 ACC</p>	2.5								

No	Item	Criterion	AQL
10	Cracked glass	The LCD with extensive crack is not acceptable.	2.5
11	Backlight elements	11.1 Illumination source flickers when lit.	1.0
		11.2 Spots or scratches that appear when lit must be judged using LCD spot, lines and contamination standards.	2.5
		11.3 Backlight does n't light or color is wrong.	1.0
12	Bezel	12.1 Bezel may not have rust, be deformed or have fingerprints, stains or other contamination.	2.5
		12.2 Bezel must comply with job specifications.	1.0
13	PCB, COB	13.1 COB seal may not have pin holes larger than 0.2mm or contamination.	2.5
		13.2 COB seal surface may not have pinholes through to the IC.	2.5
		13.3 The height of the COB should not exceed the height indicated in the assembly diagram.	1.0
		13.4 There may not be more than 2mm of sealant outside the seal area on the PCB. And there should be no more than three places.	2.5
		13.5 No oxidation or contamination on PCB terminals.	2.5
		13.6 Parts on PCB must be the same as on the production characteristic chart. There should be no wrong parts, missing parts or excess parts.	1.0
		13.7 The jumper on the PCB should conform to the product characteristic chart.	1.0
		13.8 If solder gets on bezel tab pads, LED pad, zebra pad or screw hole pad, make sure it is smoothed down.	2.5
14	Soldering	14.1 No unmelted solder paste may be present on the PCB.	2.5
		14.2 No cold solder joints, missing solder connections, oxidation or icicle.	2.5
		14.3 No residue or solder balls on PCB.	2.5
		14.4 No short circuits in components on PCB.	1.0

No	Item	Criterion	AQL
15	General appearance	15.1 No oxidation, contamination, curves or, bends on interface Pin (OLB) of TCP.	2.5
		15.2 No cracks on interface pin (OLB) of TCP.	1.0
		15.3 No contamination, solder residue or solder balls on product.	2.5
		15.4 The IC on the TCP may not be damaged, circuits.	2.5
		15.5 The uppermost edge of the protective strip on the interface pin must be present or look if it cause the in interface pin to sever.	2.5
		15.6 The residual rosin or tin oil of soldering (component or chip component ) is not burned into brown or black color.	2.5
		15.7 Sealant on top of the ITO circuit has not hardened.	2.5
		15.8 Pin type must match type in specification sheet.	1.0
		15.9 LCD pin loose or missing pins.	1.0
		15.10 Product packaging must the same as specified on packaging specification sheet.	1.0
		15.11 Product dimension and structure must conform to product specification sheet.	1.0
		15.12 The appearance of Heat Seal should not admit any dirt and break.	

## 16. Precautions For Use Of LCD Modules

### A. Liquid Crystal Display Modules (LCM)

#### a. Mechanical Considerations

LCM are assembled and adjusted with a high degree of precision. Avoid excessive shocks and do not make any alterations or modifications. The following should be noted.

- .) Do not tamper in any way with the tabs on the metal frame.
- .) Do not modify the PCB by drilling extra holes, changing its outline, moving its components or modifying its pattern.
- .) Do not touch the elastomer connector (conductive rubber), especially when inserting an EL panel.
- .) When mounting a LCM make sure that the PCB is not under any stress such as bending or twisting. Elastomer contacts are very delicate and missing pixels could result from slight dislocation of any of the elements.
- .) Avoid pressing on the metal bezel, otherwise the elastomer connector could be deformed and lose contact, resulting in missing pixels.

#### b. Static Electricity

LCM contains CMOS LSI's and the same precaution for such devices should apply, namely:

- .) The operator should be grounded whenever he comes into contact with the module. Never touch any of the conductive parts such as the LSI pads, the copper leads on the PCB and the interface terminals with any part of the human body.

- .) The modules should be kept in antistatic bags or other containers resistant to static for storage.
  - .) Only properly grounded soldering irons should be used.
  - .) If an electric screw driver is used it should be well grounded and shielded from commutator sparks.
  - .) The normal static prevention measures should be observed for work clothes and working benches; for the latter conductive(rubber)mat is recommended.
  - .) Since dry air is inductive to statics, a relative humidity of 50 – 60% is recommended.
- c. Soldering**
- .) Solder only to the I/O terminals.
  - .) Use only soldering irons with proper grounding and no leakage.
  - .) Soldering temperature is  $280 \pm 10$  .
  - .) Soldering time: 3 to 4 seconds.
  - .) Use eutectic solder with resin flux fill.
  - .) If flux is used. The LCD surface should be covered to avoid flux spatters. Flux residue should be removed afterwards.
  - .) Use proper de-soldering methods(e.e. suction type desoldering irons) to remove lead wires from the I/O terminal when necessary. Do not repeat the soldering / desoldering process more than three times as the pads and plated through holes may be damaged.



---

## B. Operation

- .) The viewing angle can be adjusted by varying the LCD driving voltage  $V_o$ .
- .) Driving voltage should be kept within specified range, excess voltage shortens display life.
- .) Response time increases with decrease in temperature.
- .) Display may turn black or dark Blue at temperatures above its operational range; this is however not destructive and the display will return to normal once the temperature falls back to range.
- .) Mechanical disturbance during operation (such as pressing on the viewing area) may cause the segments to appear “fractured”. They will recover once the display is turned off.
- .) Condensation at terminals will cause malfunction and possible electrochemical reaction. Relative humidity of the environment should therefore be kept below 60%.

## C. Storage

- .) LCD's should be kept in sealed polyethylene bags while LCM's should use antistatic ones. If properly sealed, there is no need for desiccant.
- .) Store in dark places and do not expose to sunlight or fluorescent light. Keep the temperature between 0 and 35 and the relative humidity low. Please consult JEWEL HILL for other storage requirements.

## D. Safety

If any fluid leaks out of a damaged glass cell, wash off any human part that comes into contact with soap and water. Never swallow the fluid. The toxicity is extremely low but caution should be exercised at all times.