

SHINDENGEN

Schottky Rectifiers (SBD)

SBD Bridges

D4SBS4

40V 4A

FEATURES

- Thin Single In-Line Package
- SBD Bridge
- Low VF

APPLICATION

- Switching power supply
- Home Appliances, Office Equipment
- Telecommunication, Factory Automation

OUTLINE DIMENSIONS

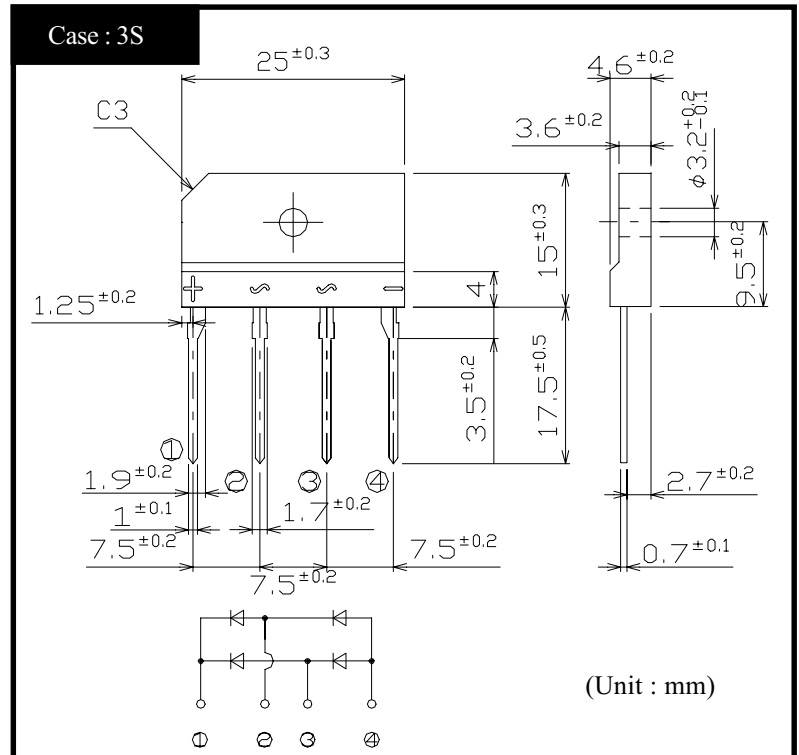

RATINGS

● Absolute Maximum Ratings (If not specified Tc=25°C)

Item	Symbol	Conditions	Ratings	Unit
Storage Temperature	Tstg		-55~150	°C
Operating Junction Temperature	Tj		150	°C
Maximum Reverse Voltage	V _{RM}		40	V
Repetitive Peak Surge Reverse Voltage	V _{RRSM}	Pulse width 0.5ms, duty 1/40	45	V
Average Rectified Forward Current	I _O	50Hz sine wave, R-load With heatsink Tc=116°C	4	A
		50Hz sine wave, R-load Without heatsink Ta=33°C	2.3	
Peak Surge Forward Current	I _{FSM}	50Hz sine wave, Non-repetitive 1cycle peak value, Tj=25°C	60	A
Repetitive Peak Surge Reverse Power	P _{RRSM}	Pulse width 10 μs, Rating of per diode, Tj=25°C	160	W
Dielectric Strength	Vdis	Terminals to case, AC 1 minute	2	kV
Mounting Torque	TOR	(Recommended torque: 0.5N·m)	0.8	N·m

● Electrical Characteristics (If not specified Tc=25°C)

Item	Symbol	Conditions	Ratings	Unit
Forward Voltage	V _F	IF=2A, Pulse measurement, Rating of per diode	Max.0.55	V
Reverse Current	I _R	VR=V _{RM} , Pulse measurement, Rating of per diode	Max.2	mA
Junction Capacitance	Cj	f=1MHz, VR=10V, Rating of per arm	TYP 95	pF
Thermal Resistance	θ _{jc}	junction to case With heatsink	Max.5.5	°C/W
	θ _{jl}	junction to lead Without heatsink	Max.6	
	θ _{ja}	junction to ambient Without heatsink	Max.40	

D4SBS4

Forward Voltage

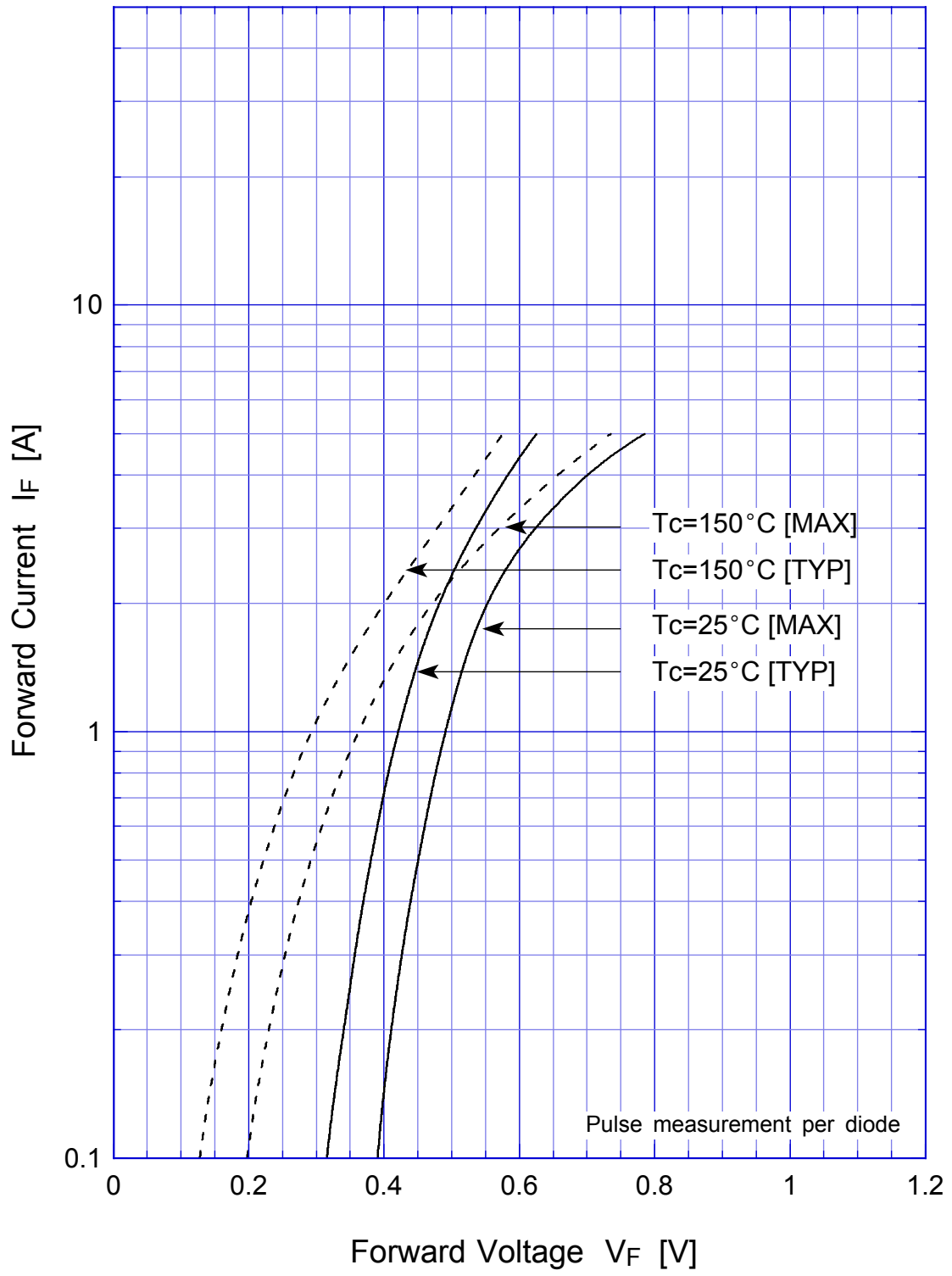

D4SBS4 Junction Capacitance

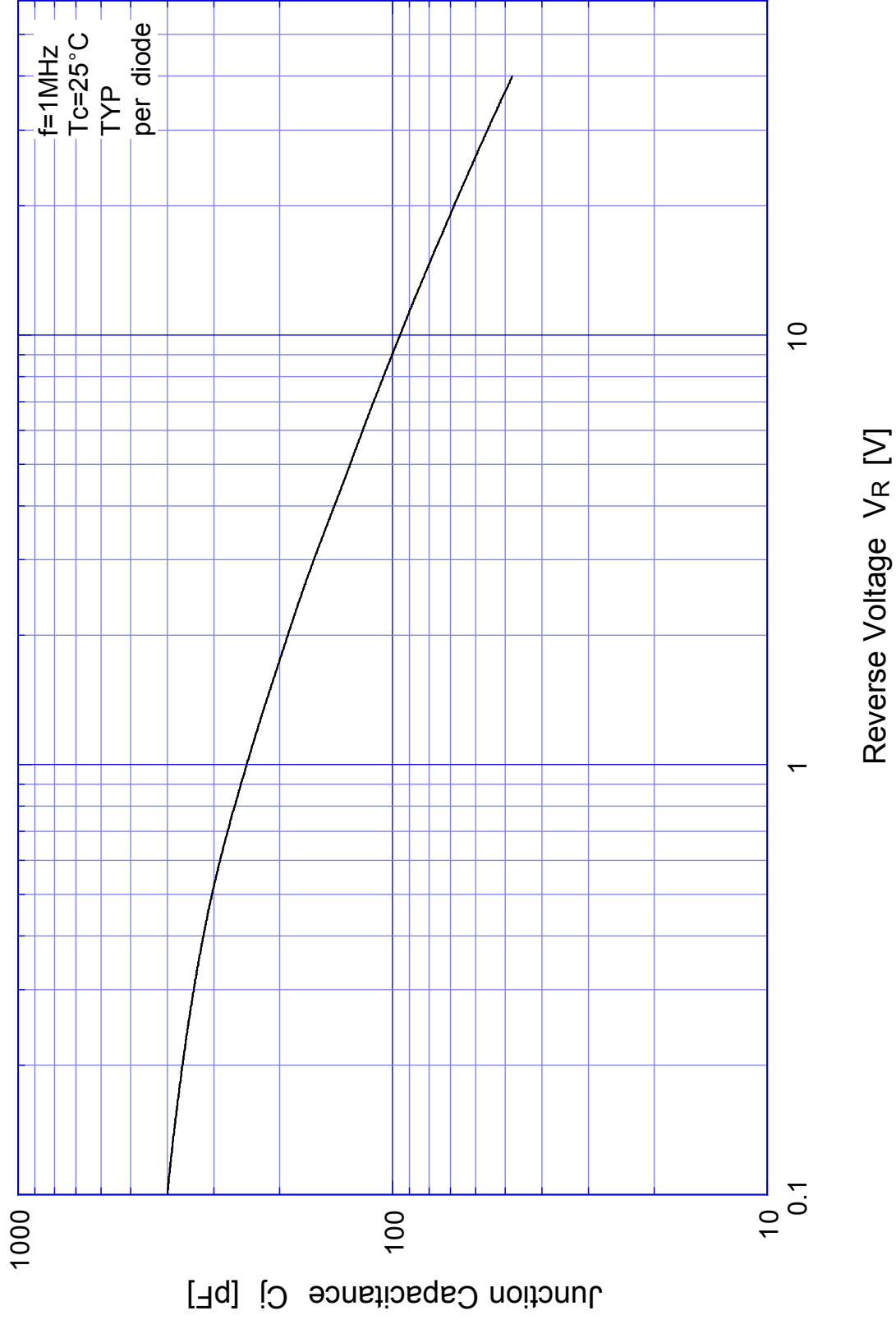

D4SBS4

Reverse Current

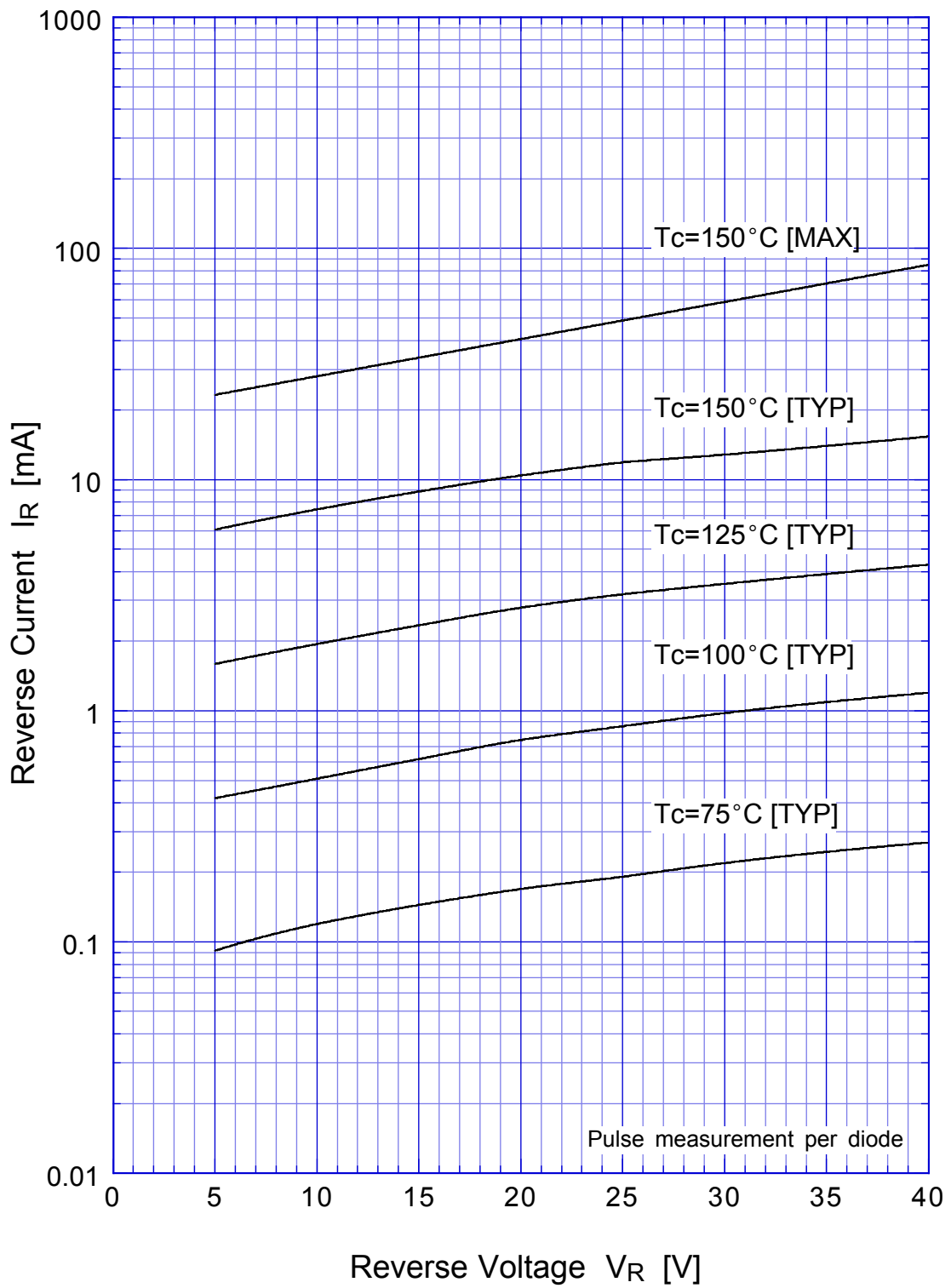

D4SBS4 Reverse Power Dissipation

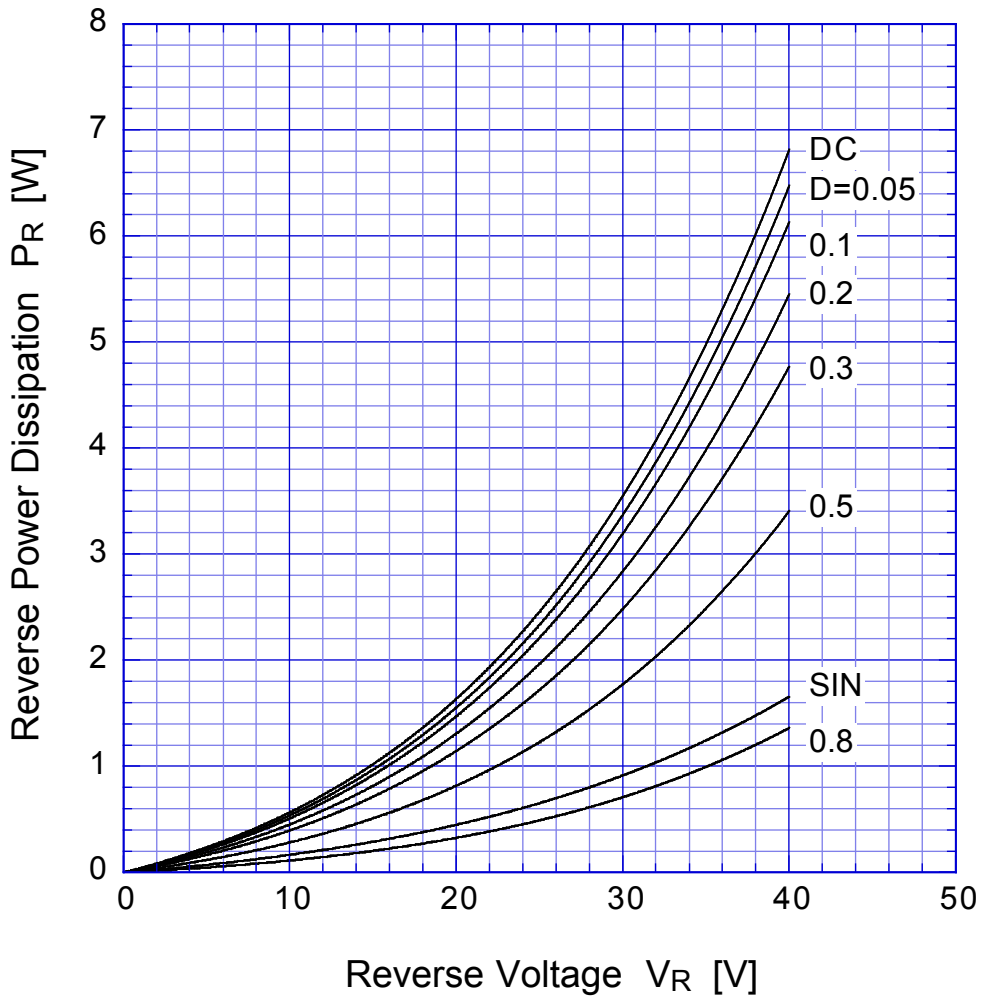

$T_j = 150^\circ\text{C}$

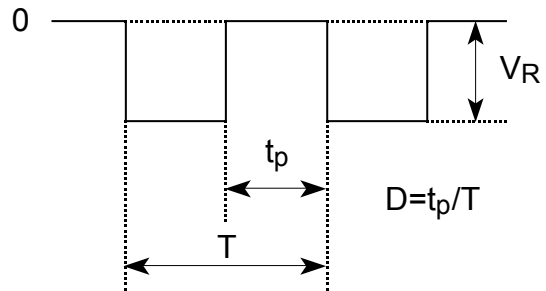

D4SBS4 Forward Power Dissipation

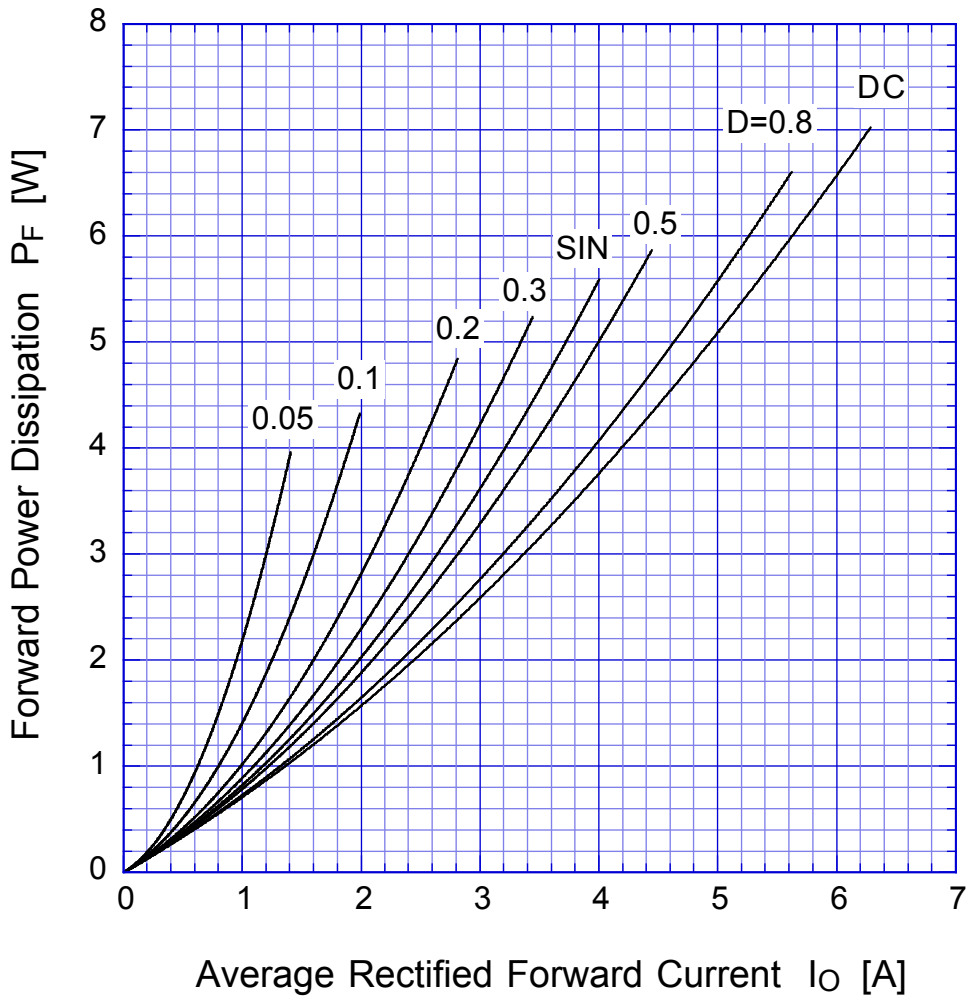

$T_j = 150^\circ\text{C}$

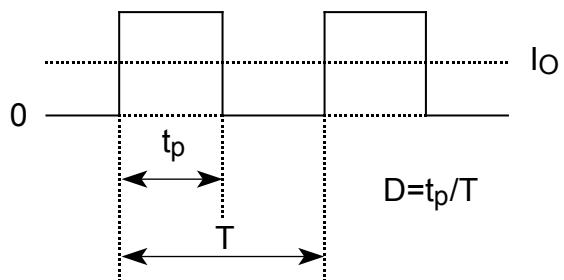

D4SBS4

Derating Curve

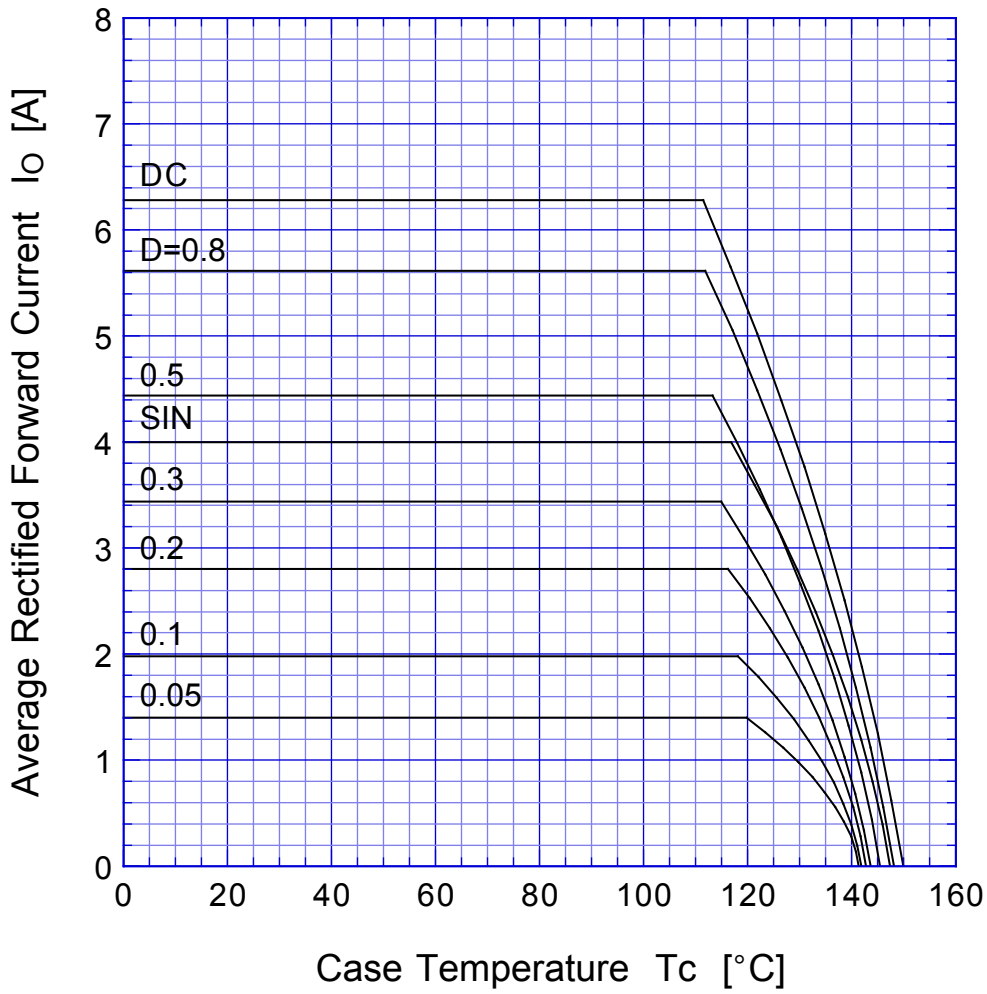

$V_R = 20V$



D4SBS4

Derating Curve

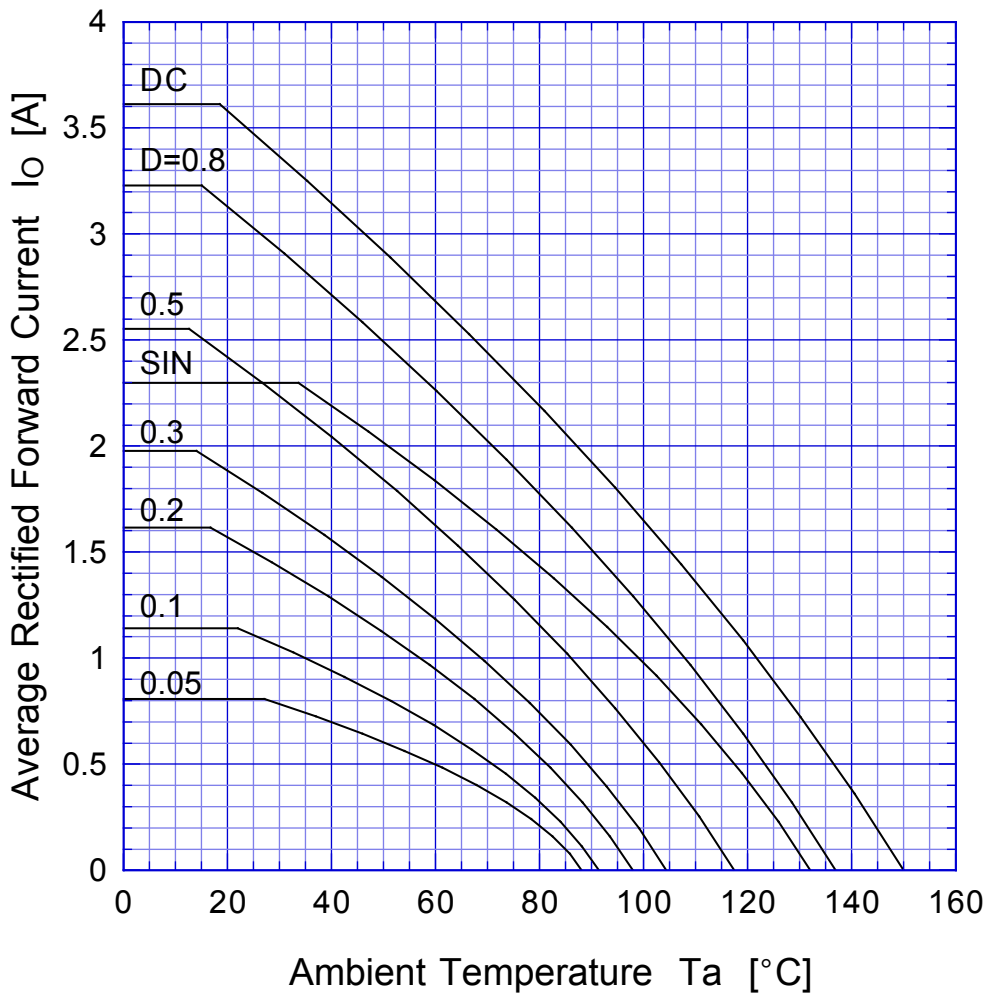

$V_R = 20V$

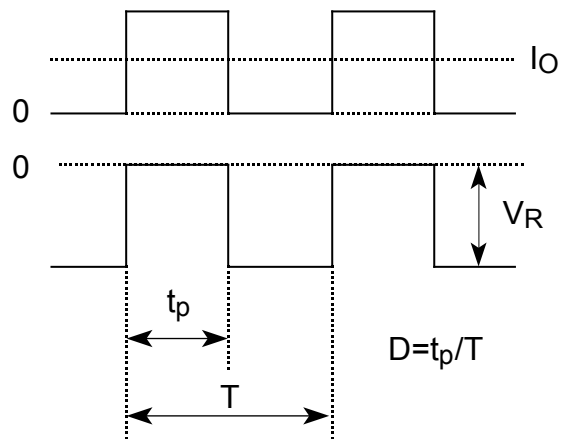

D4SBS4

Peak Surge Forward Capability

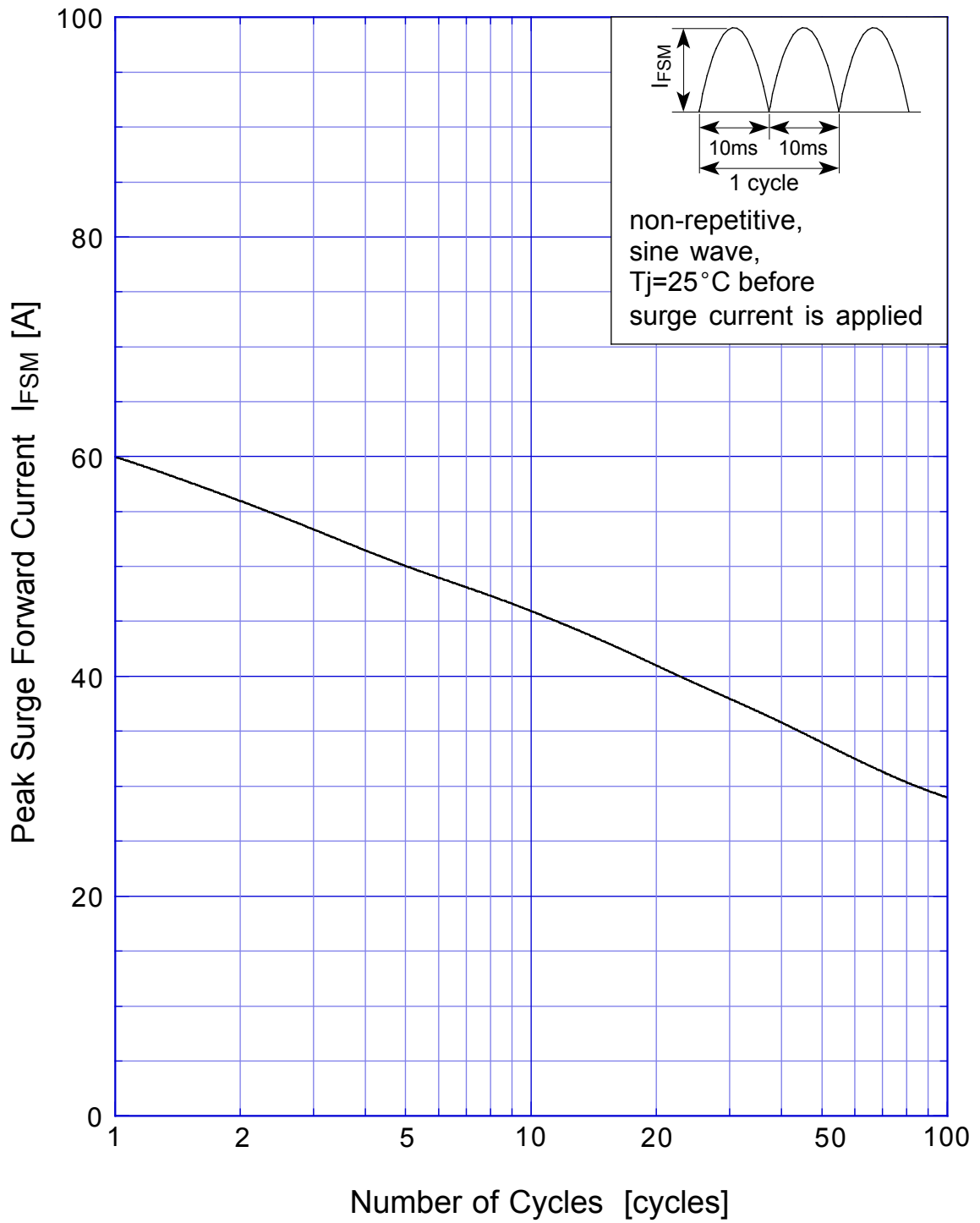

SBD Repetitive Surge Reverse Power Derating Curve

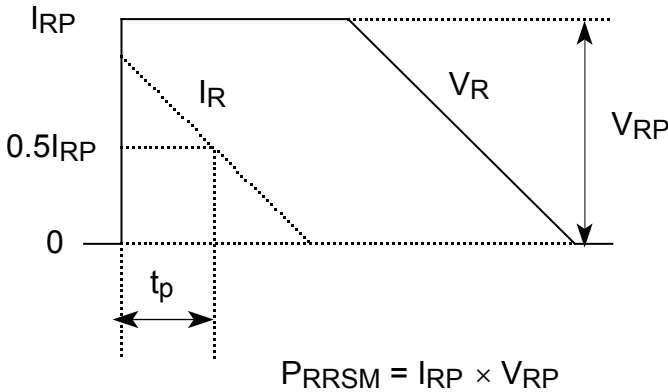
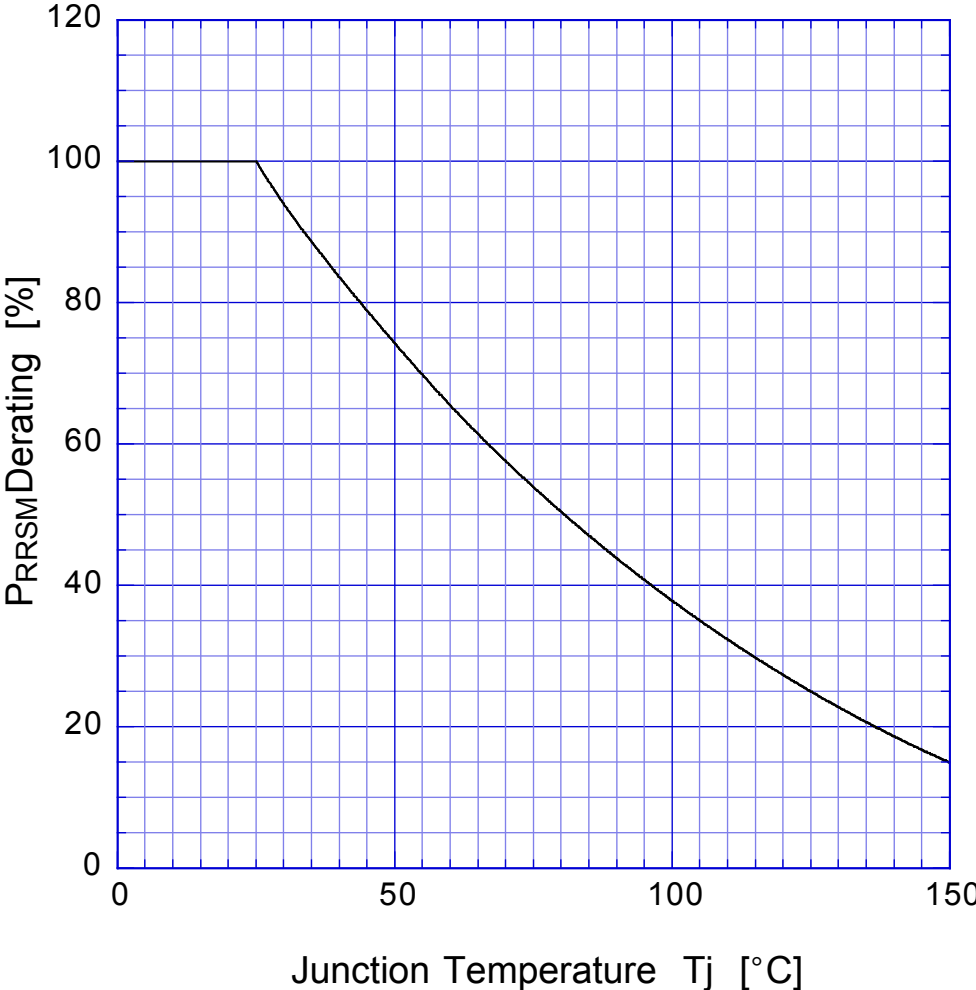

SBD

Repetitive Surge Reverse Power Capability

