

General Description

The AOC2802 uses advanced trench technology to provide excellent $R_{SS(ON)}$, low gate charge and operation with gate voltages as low as 2.5V while retaining a 12V $V_{GS(MAX)}$ rating. It is ESD protected. This device is suitable for use as a uni-directional or bi-directional load switch, facilitated by its common-drain configuration.

Features

V_{SS}	20V
I_D (at $V_{GS}=4.5V$)	6A
$R_{SS(ON)}$ (at $V_{GS}=4.5V$)	< 34m Ω
$R_{SS(ON)}$ (at $V_{GS}=4.0V$)	< 35m Ω
$R_{SS(ON)}$ (at $V_{GS}=3.1V$)	< 43m Ω
$R_{SS(ON)}$ (at $V_{GS}=2.5V$)	< 54m Ω



WLCSP 1.57x1.57_4

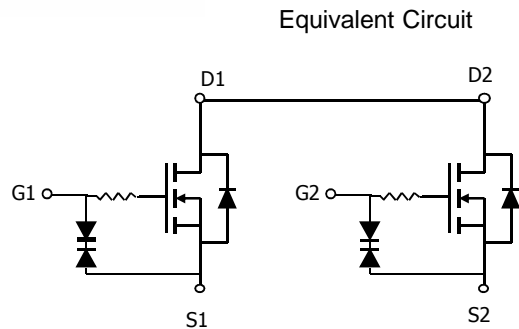
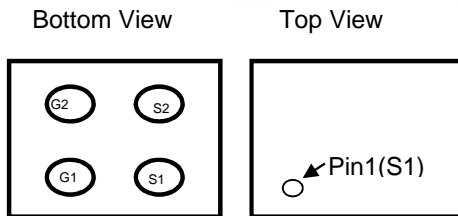

Absolute Maximum Ratings $T_A=25^\circ\text{C}$ unless otherwise noted

Parameter	Symbol	Maximum	Units
Source-Source Voltage	V_{SS}	20	V
Gate-Source Voltage	V_{GS}	± 12	V
Source Current (DC) ^{Note1}	I_S	6	A
Source Current (Pulse) ^{Note2}			
Power Dissipation ^{Note1}	P_D	1.3	W
$T_A=25^\circ\text{C}$			
Junction and Storage Temperature Range	T_J, T_{STG}	-55 to 150	$^\circ\text{C}$

Note 1. Mounted on minimum pad PCB

Note 2. PW < 300 μs pulses, duty cycle 0.5% max

Electrical Characteristics (T_J=25°C unless otherwise noted)

Symbol	Parameter	Conditions	Min	Typ	Max	Units
STATIC PARAMETERS						
BV _{SSS}	Source-Source Breakdown Voltage	I _S =250μA, V _{GS} =0V, Test Circuit 6	20			V
I _{SSS}	Zero Gate Voltage Source Current	V _{SS} =20V, V _{GS} =0V, Test Circuit 1			1	μA
		T _J =55°C			5	
I _{GSS}	Gate leakage current	V _{SS} =0V, V _{GS} = ±10V, Test Circuit 2		1	10	
BV _{GSO}	Gate-Source Breakdown Voltage	V _{SS} =0V, I _G =±250μA, Test Circuit 7	±12			V
V _{GS(th)}	Gate Threshold Voltage	V _{SS} =V _{GS} I _S =250μA, Test Circuit 3	0.5	1	1.5	V
R _{SS(ON)}	Static Source to Source On-Resistance <small>Note</small>	V _{GS} =4.5V, I _S =3A, Test Circuit 4		28	34	mΩ
		T _J =125°C		41	48	
		V _{GS} =4.0V, I _S =3A, Test Circuit 4		30	35	
		V _{GS} =3.1V, I _S =3A, Test Circuit 4		36	43	
		V _{GS} =2.5V, I _S =3A, Test Circuit 4		45	54	
g _{FS}	Forward Transconductance <small>Note</small>	V _{SS} =5V, I _S =3A, Test Circuit 3		19		S
V _{FSS}	Diode Forward Voltage <small>Note</small>	I _S =1A, V _{GS} =0V, Test Circuit 5		0.6	1	V
DYNAMIC PARAMETERS						
C _{iss}	Input Capacitance	V _{GS} =0V, V _{SS} =10V, f=1MHz,		1000	1200	pF
C _{oss}	Output Capacitance			152		pF
C _{rss}	Reverse Transfer Capacitance			114		pF
R _g	Gate resistance	V _{GS} =0V, V _{SS} =0V, f=1MHz		1.5		kΩ
SWITCHING PARAMETERS						
t _{D(on)}	Turn-On DelayTime	V _{GS} =10V, V _{SS} =10V, R _L =1.5Ω, R _{GEN} =6Ω ,		284		ns
t _r	Turn-On Rise Time			900		ns
t _{D(off)}	Turn-Off DelayTime			5		μs
t _f	Turn-Off Fall Time			4.8		μs
Q _g	Total Gate Charge	V _{GS1} =4.5V, V _{SS} =10V, I _S =6A		10.4		nC

Note: Pulsed

THIS PRODUCT HAS BEEN DESIGNED AND QUALIFIED FOR THE CONSUMER MARKET. APPLICATIONS OR USES AS CRITICAL COMPONENTS IN LIFE SUPPORT DEVICES OR SYSTEMS ARE NOT AUTHORIZED. AOS DOES NOT ASSUME ANY LIABILITY ARISING OUT OF SUCH APPLICATIONS OR USES OF ITS PRODUCTS. AOS RESERVES THE RIGHT TO IMPROVE PRODUCT DESIGN, FUNCTIONS AND RELIABILITY WITHOUT NOTICE

TYPICAL ELECTRICAL AND THERMAL CHARACTERISTICS

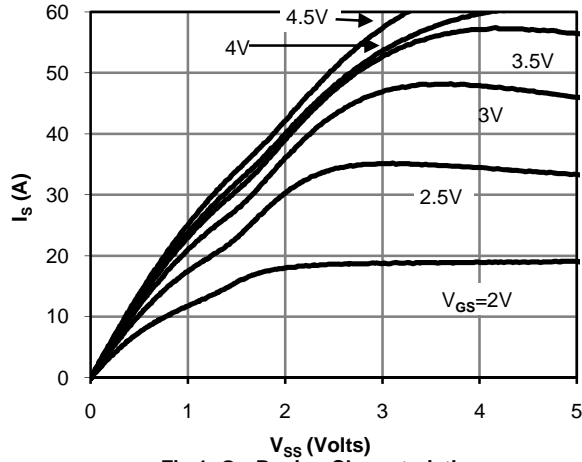

Fig 1: On-Region Characteristics

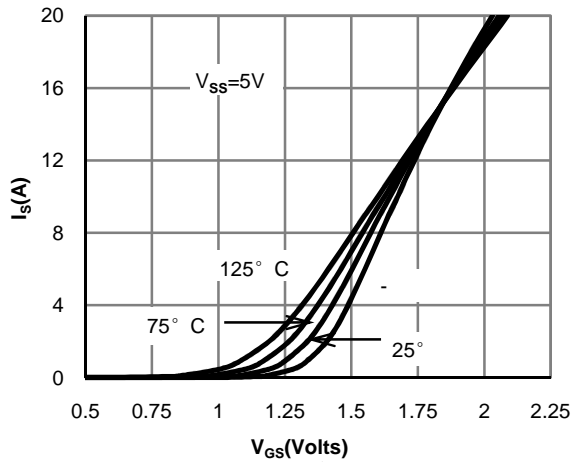

Figure 2: Transfer Characteristics

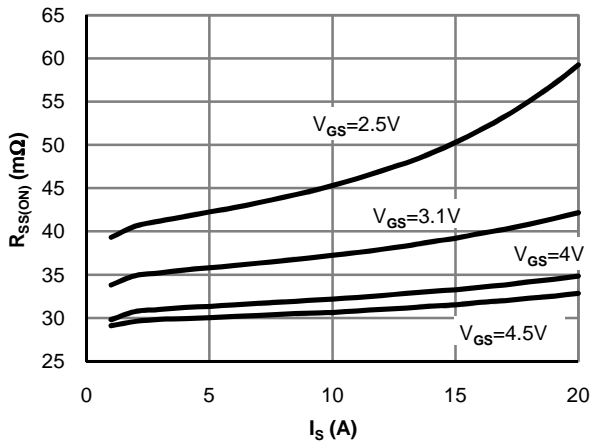

Figure 3: On-Resistance vs. Drain Current and Gate Voltage

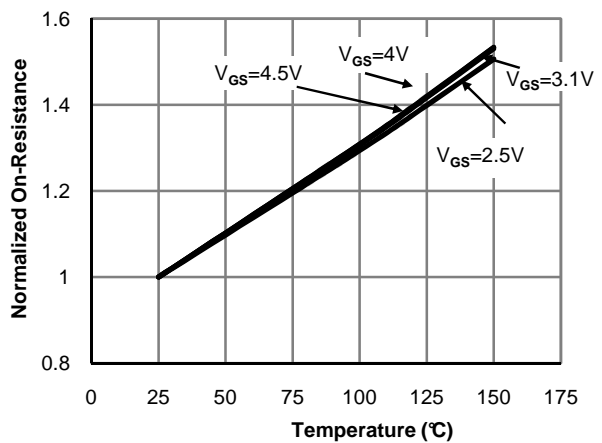

Figure 4: On-Resistance vs. Junction Temperature

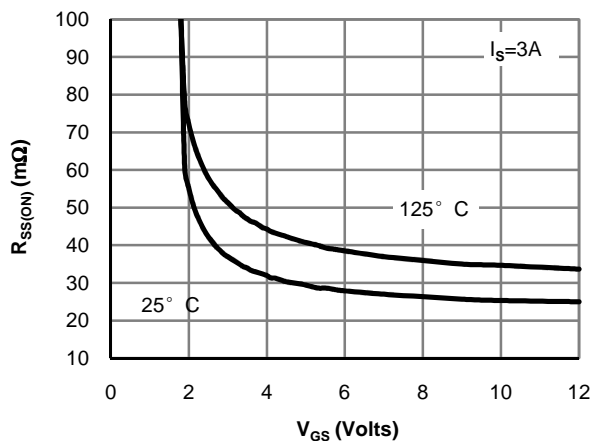

Figure 5: On-Resistance vs. Gate-Source Voltage

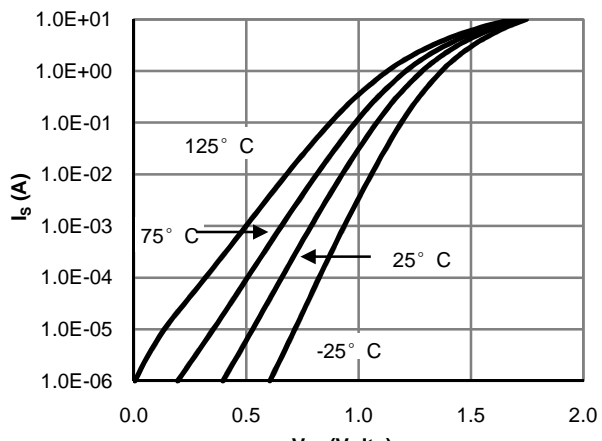

Figure 6: Body-Diode Characteristics

TYPICAL ELECTRICAL AND THERMAL CHARACTERISTICS

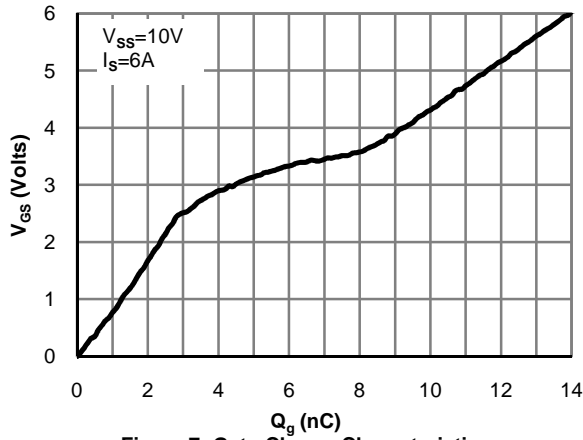

Figure 7: Gate-Charge Characteristics

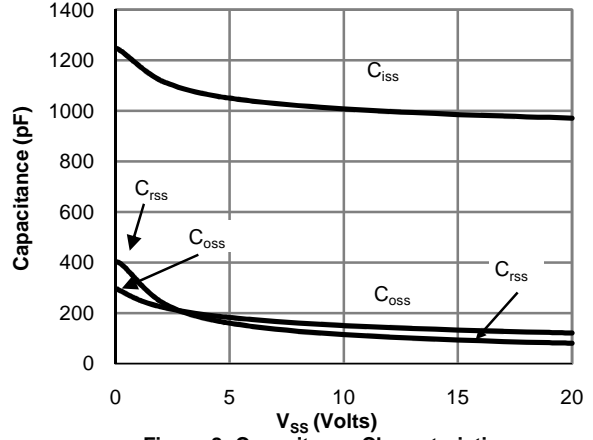

Figure 8: Capacitance Characteristics

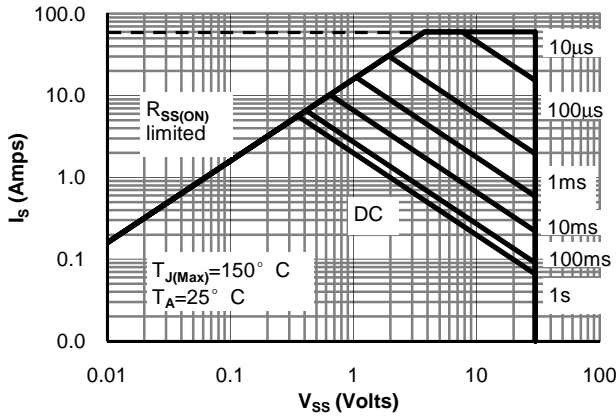

Figure 9: Maximum Forward Biased Safe Operating Area (Note E)

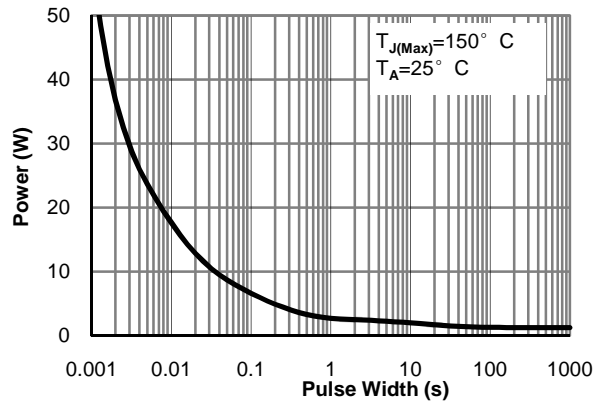

Figure 10: Single Pulse Power Rating Junction-to-Ambient (Note E)

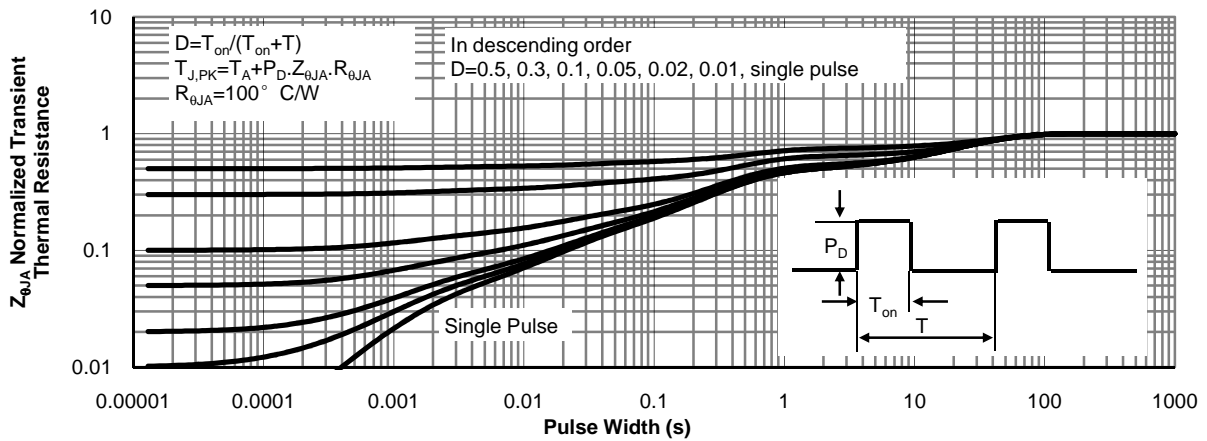

Figure 11: Normalized Maximum Transient Thermal Impedance

