

NTMSD2P102LR2

Product Preview

FETKY™

Power MOSFET and Schottky Diode Dual SO-8 Package

Features

- High Efficiency Components in a Single SO-8 Package
- High Density Power MOSFET with Low $R_{DS(on)}$, Schottky Diode with Low V_F
- Logic Level Gate Drive
- Independent Pin-Outs for MOSFET and Schottky Die Allowing for Flexibility in Application Use
- Less Component Placement for Board Space Savings
- SO-8 Surface Mount Package, Mounting Information for SO-8 Package Provided

Applications

- Power Management in Portable and Battery-Powered Products, i.e.: Computers, Printers, PCMCIA Cards, Cellular and Cordless Telephones

MOSFET MAXIMUM RATINGS ($T_J = 25^\circ\text{C}$ unless otherwise noted)

Rating	Symbol	Value	Unit
Drain-to-Source Voltage	V_{DSS}	-20	V
Gate-to-Source Voltage – Continuous	V_{GS}	± 10	V
Thermal Resistance – Junction-to-Ambient (Note 1.)	$R_{\theta JA}$	175	$^\circ\text{C/W}$
Total Power Dissipation @ $T_A = 25^\circ\text{C}$	P_D	0.71	W
Continuous Drain Current @ $T_A = 25^\circ\text{C}$	I_D	-2.3	A
Continuous Drain Current @ $T_A = 100^\circ\text{C}$	I_D	-1.45	A
Pulsed Drain Current (Note 4.)	I_{DM}	-9.0	A
Thermal Resistance – Junction-to-Ambient (Note 2.)	$R_{\theta JA}$	105	$^\circ\text{C/W}$
Total Power Dissipation @ $T_A = 25^\circ\text{C}$	P_D	1.19	W
Continuous Drain Current @ $T_A = 25^\circ\text{C}$	I_D	-2.97	A
Continuous Drain Current @ $T_A = 100^\circ\text{C}$	I_D	-1.88	A
Pulsed Drain Current (Note 4.)	I_{DM}	-12	A
Thermal Resistance – Junction-to-Ambient (Note 3.)	$R_{\theta JA}$	62.5	$^\circ\text{C/W}$
Total Power Dissipation @ $T_A = 25^\circ\text{C}$	P_D	2.0	W
Continuous Drain Current @ $T_A = 25^\circ\text{C}$	I_D	-3.85	A
Continuous Drain Current @ $T_A = 100^\circ\text{C}$	I_D	-2.43	A
Pulsed Drain Current (Note 4.)	I_{DM}	-15	A
Operating and Storage Temperature Range	T_J, T_{stg}	-55 to +150	$^\circ\text{C}$
Single Pulse Drain-to-Source Avalanche Energy – Starting $T_J = 25^\circ\text{C}$ ($V_{DD} = -20$ Vdc, $V_{GS} = -4.5$ Vdc, Peak $I_L = -5.0$ Apk, $L = 28$ mH, $R_G = 25$ Ω)	E_{AS}	350	mJ
Maximum Lead Temperature for Soldering Purposes, 1/8" from case for 10 seconds	T_L	260	$^\circ\text{C}$

1. Minimum FR-4 or G-10 PCB, Steady State.
2. Mounted onto a 2" square FR-4 Board (1" sq. 2 oz Cu 0.06" thick single sided), Steady State.
3. Mounted onto a 2" square FR-4 Board (1" sq. 2 oz Cu 0.06" thick single sided), $t \leq 10$ seconds.
4. Pulse Test: Pulse Width = 300 μs , Duty Cycle = 2%.

This document contains information on a product under development. ON Semiconductor reserves the right to change or discontinue this product without notice.



ON Semiconductor™

<http://onsemi.com>

MOSFET
-2.3 AMPERES
-20 VOLTS
90 m Ω @ $V_{GS} = -4.5$ V

SCHOTTKY DIODE
2.0 AMPERES
20 VOLTS
58 mV @ $I_F = 2.0$ A

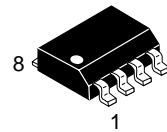

SO-8
CASE 751
STYLE 18

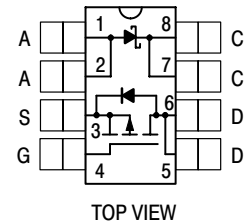

MARKING DIAGRAM & PIN ASSIGNMENTS

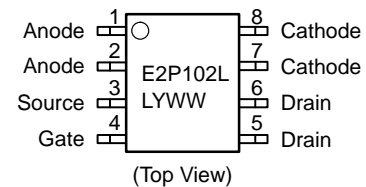

E2P102L= Device Code
L = Assembly Location
Y = Year
WW = Work Week

ORDERING INFORMATION

Device	Package	Shipping
NTMSD2P102LR2	SO-8	2500/Tape & Reel

NTMSD2P102LR2

SCHOTTKY MAXIMUM RATINGS ($T_J = 25^\circ\text{C}$ unless otherwise noted)

Rating	Symbol	Value	Unit
Peak Repetitive Reverse Voltage DC Blocking Voltage	V_{RRM} V_R	20	V
Average Forward Current (Note 5.) (Rated V_R , $T_A = 100^\circ\text{C}$)	I_O	1.0	A
Peak Repetitive Forward Current (Note 5.) (Rated V_R , Square Wave, 20 kHz, $T_A = 105^\circ\text{C}$)	I_{FRM}	2.0	A
Non-Repetitive Peak Surge Current (Note 5.) (Surge Applied at Rated Load Conditions, Half-Wave, Single Phase, 60 Hz)	I_{FSM}	20	A

5. Mounted onto a 2" square FR-4 Board (1" sq. 2 oz Cu 0.06" thick single sided), $t \leq 10$ seconds.

ELECTRICAL CHARACTERISTICS ($T_J = 25^\circ\text{C}$ unless otherwise noted) *

Characteristic	Symbol	Min	Typ	Max	Unit
----------------	--------	-----	-----	-----	------

OFF CHARACTERISTICS

Drain-to-Source Breakdown Voltage ($V_{GS} = 0$ Vdc, $I_D = -250$ μAdc) Temperature Coefficient (Positive)	$V_{(BR)DSS}$	-20 -	- -12.7	- -	Vdc mV/ $^\circ\text{C}$
Zero Gate Voltage Drain Current ($V_{DS} = -16$ Vdc, $V_{GS} = 0$ Vdc, $T_J = 25^\circ\text{C}$) ($V_{DS} = -16$ Vdc, $V_{GS} = 0$ Vdc, $T_J = 125^\circ\text{C}$)	I_{DSS}	- -	- -	-1.0 -25	μAdc
Zero Gate Voltage Drain Current ($V_{GS} = 0$ Vdc, $V_{DS} = -20$ Vdc, $T_J = 25^\circ\text{C}$)	I_{DSS}	-	-	-2.0	μAdc
Gate-Body Leakage Current ($V_{GS} = -10$ Vdc, $V_{DS} = 0$ Vdc)	I_{GSS}	-	-	-100	nAdc
Gate-Body Leakage Current ($V_{GS} = +10$ Vdc, $V_{DS} = 0$ Vdc)	I_{GSS}	-	-	100	nAdc

ON CHARACTERISTICS

Gate Threshold Voltage ($V_{DS} = V_{GS}$, $I_D = -250$ μAdc) Temperature Coefficient (Negative)	$V_{GS(th)}$	-0.5 -	-0.90 2.5	-1.5 -	Vdc mV/ $^\circ\text{C}$
Static Drain-to-Source On-State Resistance ($V_{GS} = -4.5$ Vdc, $I_D = -2.4$ Adc) ($V_{GS} = -2.7$ Vdc, $I_D = -1.2$ Adc) ($V_{GS} = -2.5$ Vdc, $I_D = -1.2$ Adc)	$R_{DS(on)}$	- - -	0.070 0.100 0.110	0.090 0.130 0.150	Ω
Forward Transconductance ($V_{DS} = -10$ Vdc, $I_D = -1.2$ Adc)	g_{FS}	-	4.2	-	Mhos

DYNAMIC CHARACTERISTICS

Input Capacitance	$(V_{DS} = -16$ Vdc, $V_{GS} = 0$ Vdc, $f = 1.0$ MHz)	C_{ISS}	-	550	750	pF
Output Capacitance		C_{OSS}	-	200	300	
Reverse Transfer Capacitance		C_{RSS}	-	100	175	

* Handling precautions to protect against electrostatic discharge is mandatory.

NTMSD2P102LR2

ELECTRICAL CHARACTERISTICS (T_J = 25°C unless otherwise noted) *

Characteristic	Symbol	Min	Typ	Max	Unit
----------------	--------	-----	-----	-----	------

SWITCHING CHARACTERISTICS (Notes 6. and 7.)

Turn-On Delay Time	(V _{DD} = -10 Vdc, I _D = -2.4 Adc, V _{GS} = -4.5 Vdc, R _G = 6.0 Ω)	t _{d(on)}	-	10	20	ns
Rise Time		t _r	-	35	65	
Turn-Off Delay Time		t _{d(off)}	-	33	60	
Fall Time		t _f	-	29	55	
Turn-On Delay Time	(V _{DD} = -10 Vdc, I _D = -1.2 Adc, V _{GS} = -2.7 Vdc, R _G = 6.0 Ω)	t _{d(on)}	-	15	-	ns
Rise Time		t _r	-	40	-	
Turn-Off Delay Time		t _{d(off)}	-	35	-	
Fall Time		t _f	-	35	-	
Total Gate Charge	(V _{DS} = -16 Vdc, V _{GS} = -4.5 Vdc, I _D = -2.4 Adc)	Q _{tot}	-	10	18	nC
Gate-Source Charge		Q _{gs}	-	1.5	-	
Gate-Drain Charge		Q _{gd}	-	5.0	-	

BODY-DRAIN DIODE RATINGS (Note 6.)

Diode Forward On-Voltage	(I _S = -2.4 Adc, V _{GS} = 0 Vdc) (I _S = -2.4 Adc, V _{GS} = 0 Vdc, T _J = 125°C)	V _{SD}	-	-0.88 -0.75	-1.0 -	Vdc
Reverse Recovery Time	(I _S = -2.4 Adc, V _{GS} = 0 Vdc, di _S /dt = 100 A/μs)	t _{rr}	-	37	-	ns
		t _a	-	16	-	
		t _b	-	21	-	
Reverse Recovery Stored Charge		Q _{RR}	-	0.025	-	μC

* Handling precautions to protect against electrostatic discharge is mandatory.

SCHOTTKY RECTIFIER ELECTRICAL CHARACTERISTICS (T_J = 25°C unless otherwise noted) (Note 6.)

Maximum Instantaneous Forward Voltage	I _F = 1.0 Adc I _F = 2.0 Adc	V _F	T _J = 25°C	T _J = 125°C	Volts
			0.47 0.58	0.39 0.53	
Maximum Instantaneous Reverse Current	V _R = 20 Vdc	I _R	T _J = 25°C	T _J = 125°C	mA
			0.05	10	
Maximum Voltage Rate of Change	V _R = 20 Vdc	dV/dt	10,000		V/μs

6. Indicates Pulse Test: Pulse Width = 300 μs max, Duty Cycle = 2%.

7. Switching characteristics are independent of operating junction temperature.

NTMSD2P102LR2

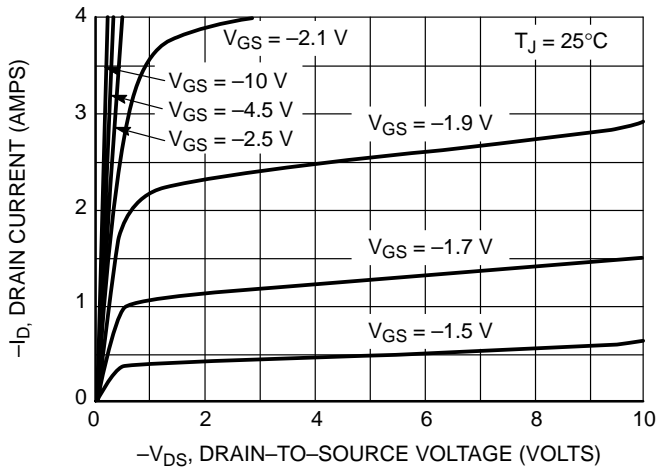

Figure 1. On-Region Characteristics.

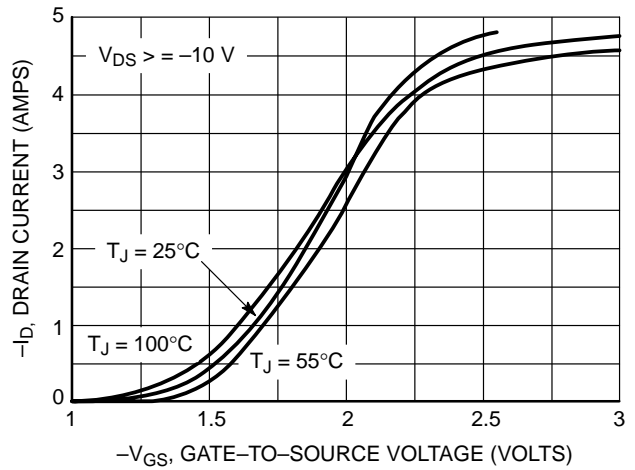

Figure 2. Transfer Characteristics.

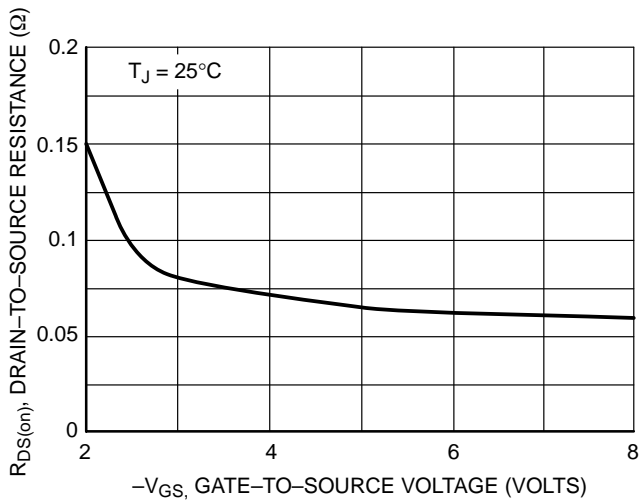

Figure 3. On-Resistance vs. Gate-to-Source Voltage.

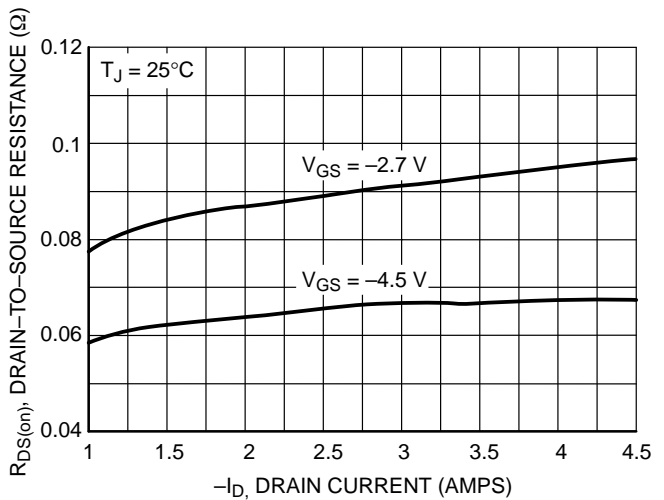

Figure 4. On-Resistance vs. Drain Current and Gate Voltage.

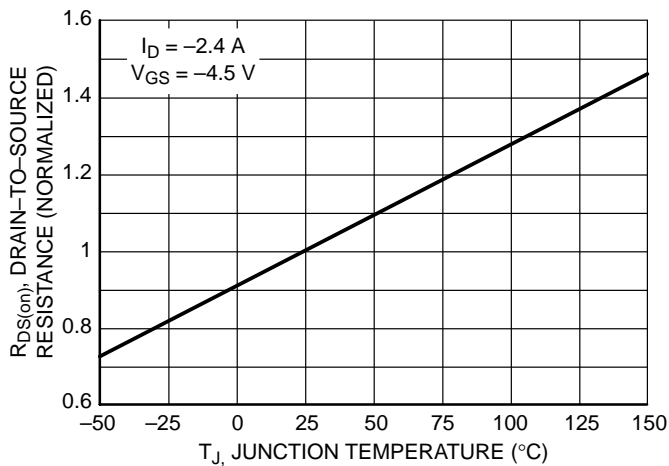

Figure 5. On-Resistance Variation with Temperature.

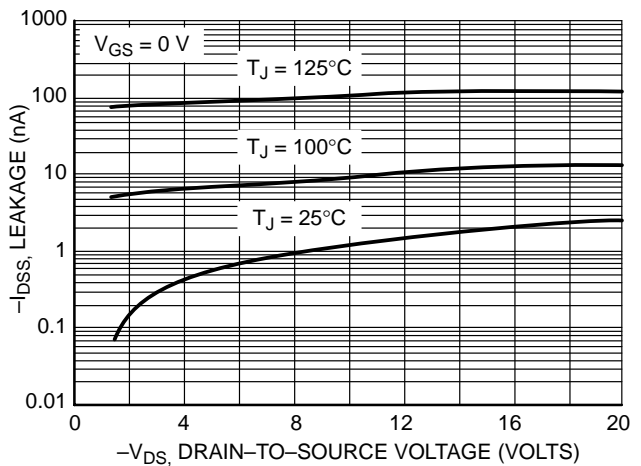

Figure 6. Drain-to-Source Leakage Current vs. Voltage.

NTMSD2P102LR2

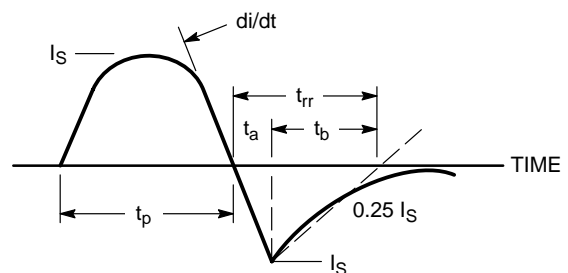
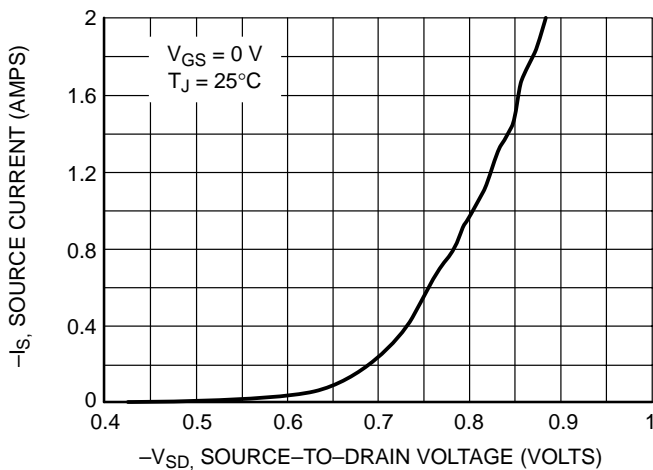
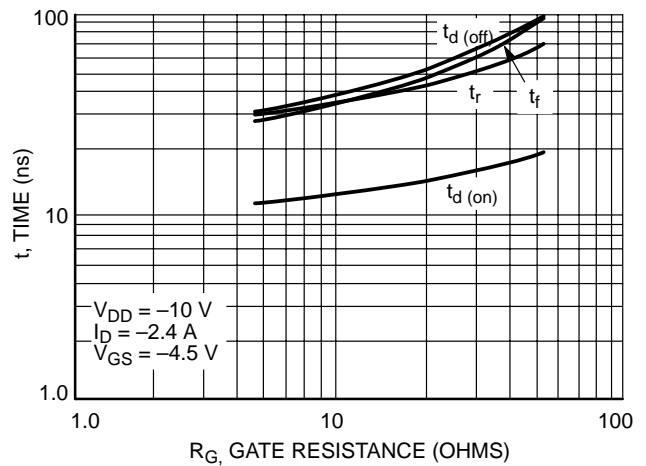
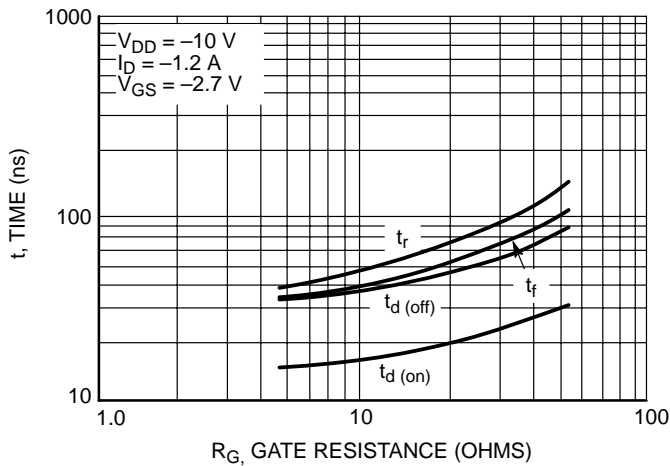
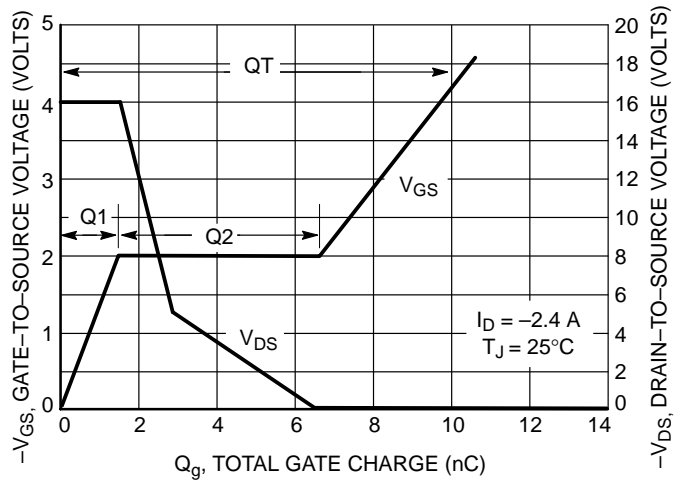
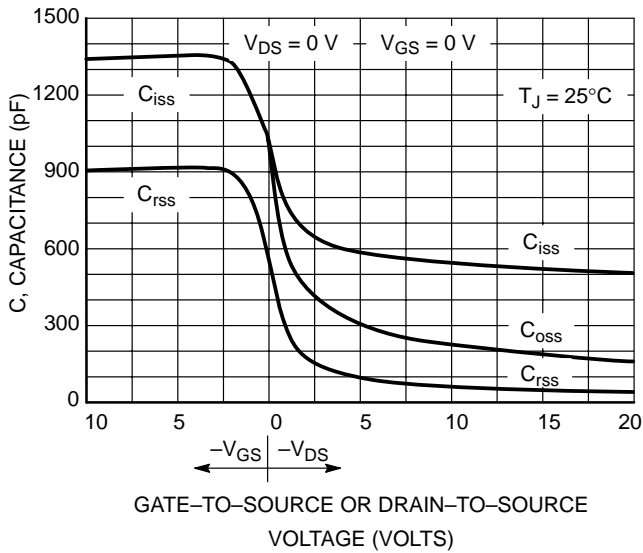

Figure 12. Diode Reverse Recovery Waveform

NTMSD2P102LR2

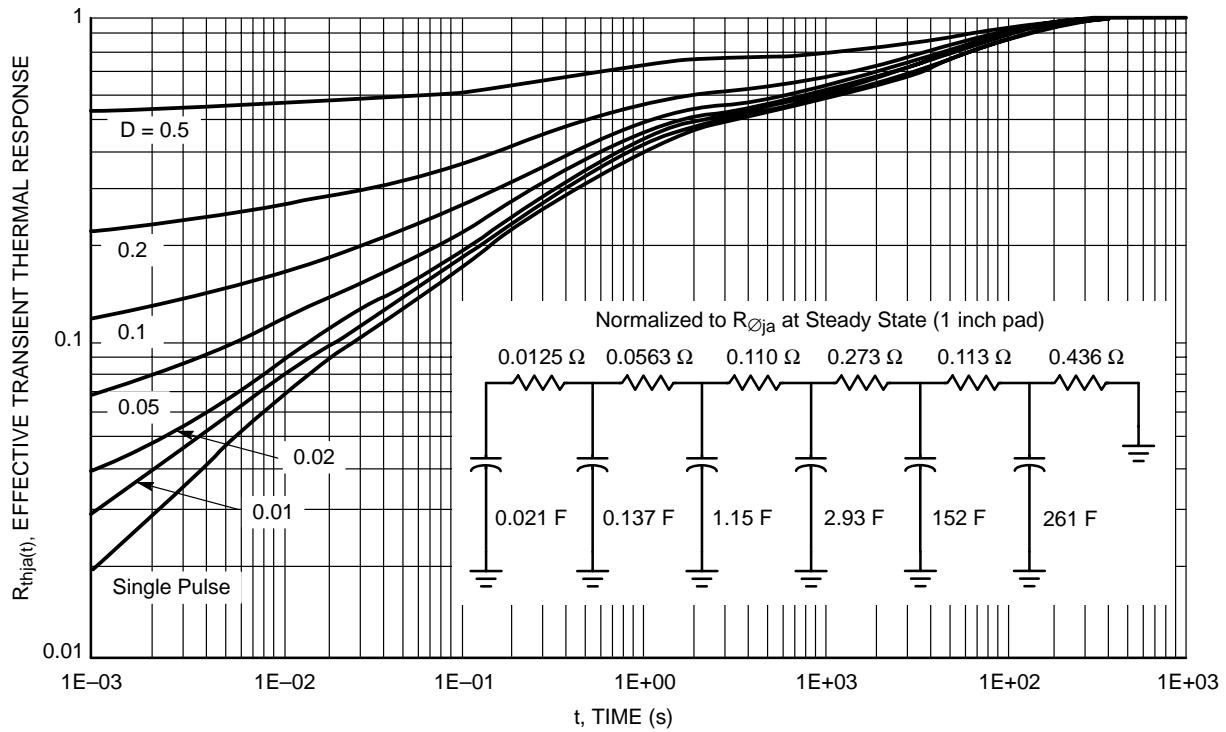

Figure 13. FET Thermal Response

TYPICAL SCHOTTKY ELECTRICAL CHARACTERISTICS

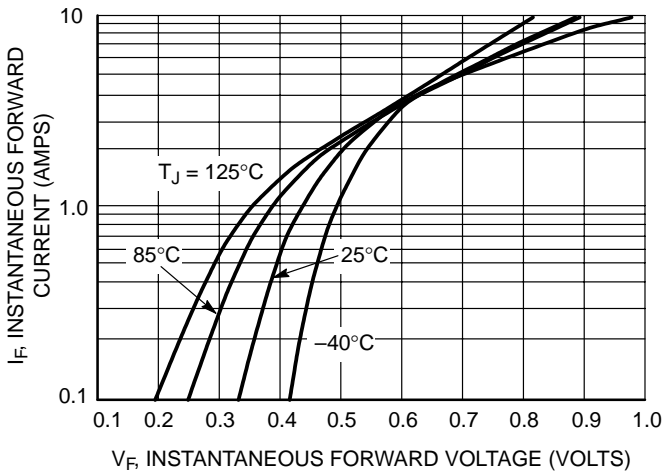

Figure 14. Typical Forward Voltage

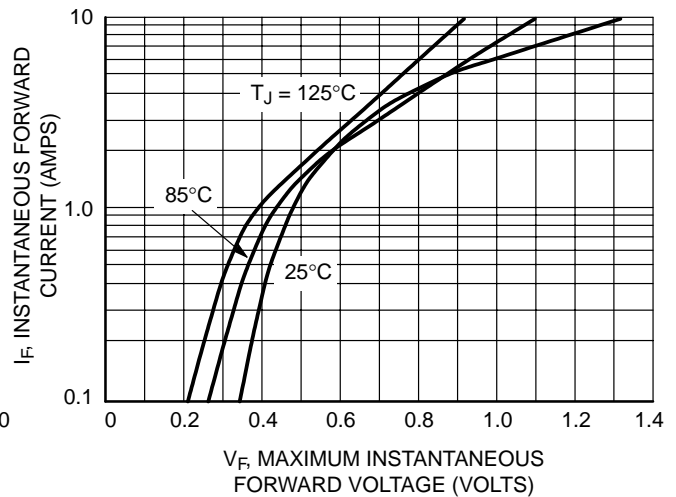

Figure 15. Maximum Forward Voltage

NTMSD2P102LR2

TYPICAL SCHOTTKY ELECTRICAL CHARACTERISTICS

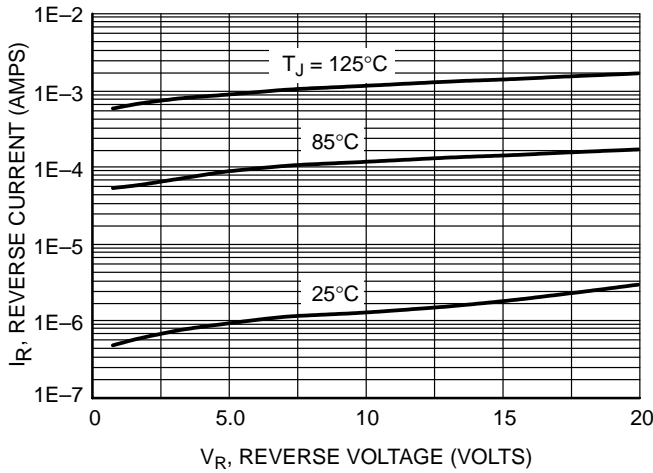

Figure 16. Typical Reverse Current

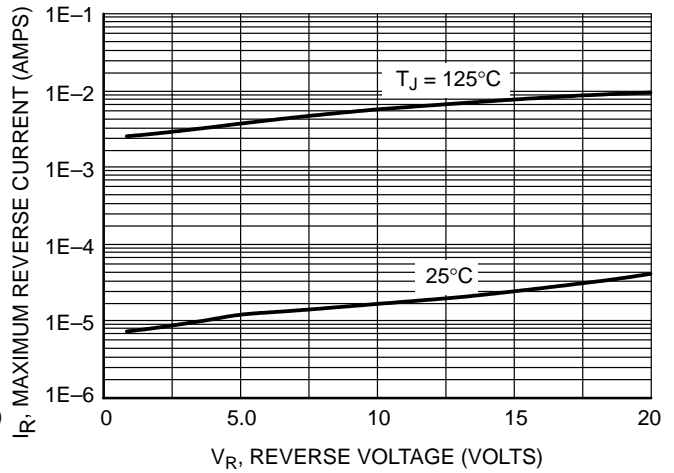

Figure 17. Maximum Reverse Current

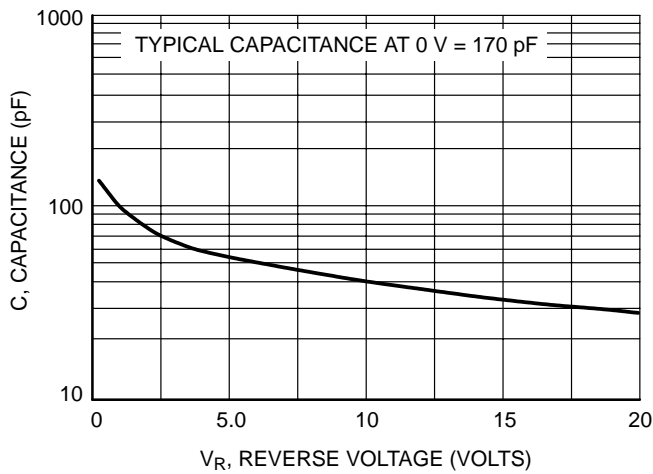

Figure 18. Typical Capacitance

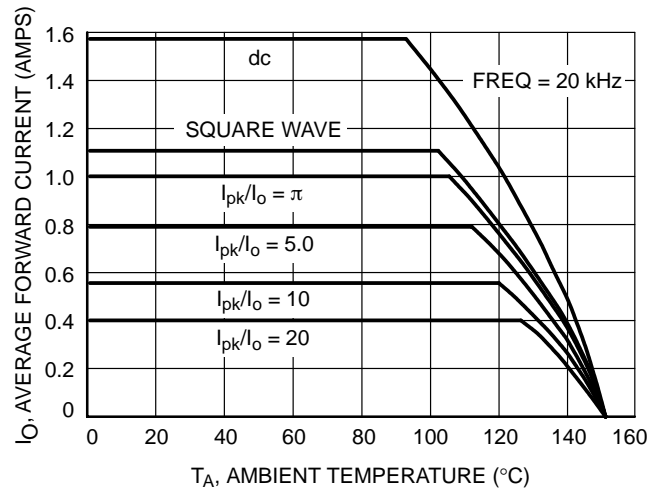

Figure 19. Current Derating

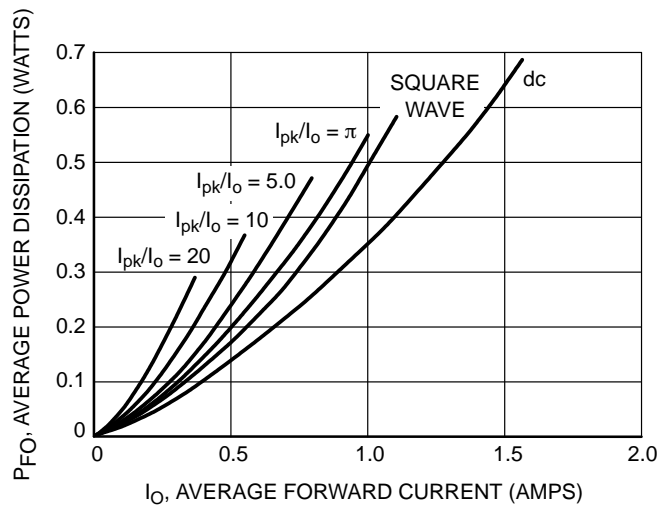

Figure 20. Forward Power Dissipation

NTMSD2P102LR2

TYPICAL SCHOTTKY ELECTRICAL CHARACTERISTICS

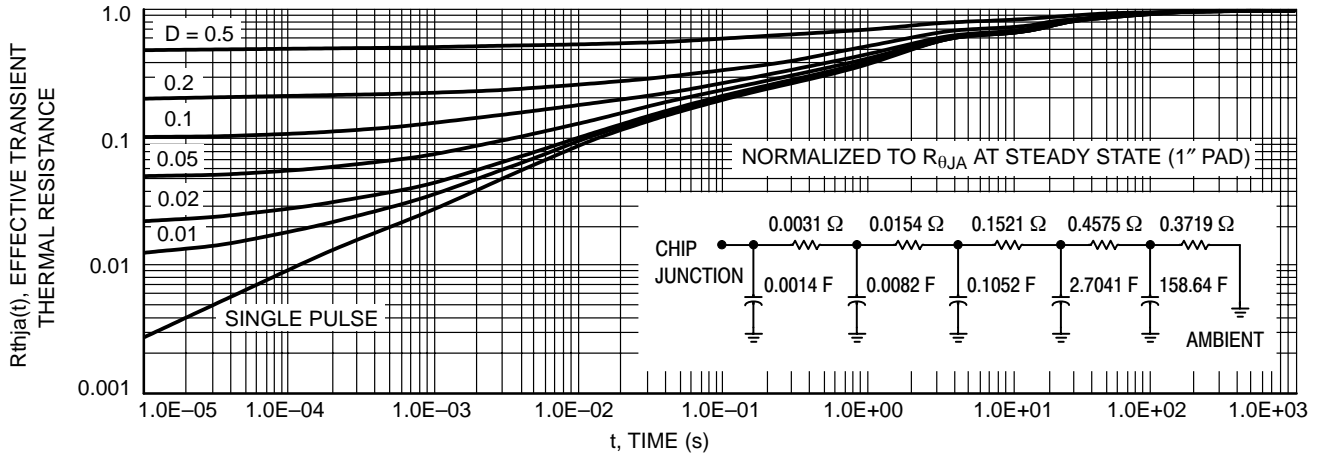

Figure 21. Schottky Thermal Response

INFORMATION FOR USING THE SO-8 SURFACE MOUNT PACKAGE

MINIMUM RECOMMENDED FOOTPRINT FOR SURFACE MOUNTED APPLICATIONS

Surface mount board layout is a critical portion of the total design. The footprint for the semiconductor packages must be the correct size to ensure proper solder connection

interface between the board and the package. With the correct pad geometry, the packages will self-align when subjected to a solder reflow process.

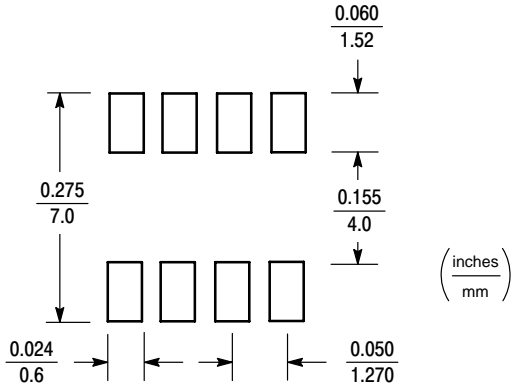

SOLDERING PRECAUTIONS

The melting temperature of solder is higher than the rated temperature of the device. When the entire device is heated to a high temperature, failure to complete soldering within a short time could result in device failure. Therefore, the following items should always be observed in order to minimize the thermal stress to which the devices are subjected.

- Always preheat the device.
- The delta temperature between the preheat and soldering should be 100°C or less.*
- When preheating and soldering, the temperature of the leads and the case must not exceed the maximum temperature ratings as shown on the data sheet. When using infrared heating with the reflow soldering method, the difference shall be a maximum of 10°C.

- The soldering temperature and time shall not exceed 260°C for more than 10 seconds.
- When shifting from preheating to soldering, the maximum temperature gradient shall be 5°C or less.
- After soldering has been completed, the device should be allowed to cool naturally for at least three minutes. Gradual cooling should be used as the use of forced cooling will increase the temperature gradient and result in latent failure due to mechanical stress.
- Mechanical stress or shock should not be applied during cooling.

* Soldering a device without preheating can cause excessive thermal shock and stress which can result in damage to the device.

TYPICAL SOLDER HEATING PROFILE

For any given circuit board, there will be a group of control settings that will give the desired heat pattern. The operator must set temperatures for several heating zones and a figure for belt speed. Taken together, these control settings make up a heating “profile” for that particular circuit board. On machines controlled by a computer, the computer remembers these profiles from one operating session to the next. Figure 22 shows a typical heating profile for use when soldering a surface mount device to a printed circuit board. This profile will vary among soldering systems, but it is a good starting point. Factors that can affect the profile include the type of soldering system in use, density and types of components on the board, type of solder used, and the type of board or substrate material being used. This profile shows

temperature versus time. The line on the graph shows the actual temperature that might be experienced on the surface of a test board at or near a central solder joint. The two profiles are based on a high density and a low density board. The Vitronics SMD310 convection/infrared reflow soldering system was used to generate this profile. The type of solder used was 62/36/2 Tin Lead Silver with a melting point between 177–189°C. When this type of furnace is used for solder reflow work, the circuit boards and solder joints tend to heat first. The components on the board are then heated by conduction. The circuit board, because it has a large surface area, absorbs the thermal energy more efficiently, then distributes this energy to the components. Because of this effect, the main body of a component may be up to 30 degrees cooler than the adjacent solder joints.

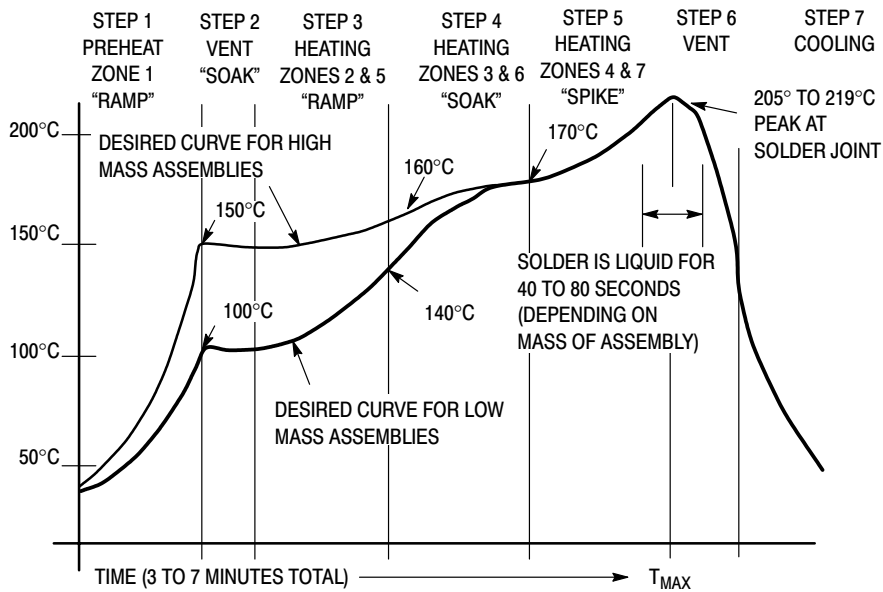
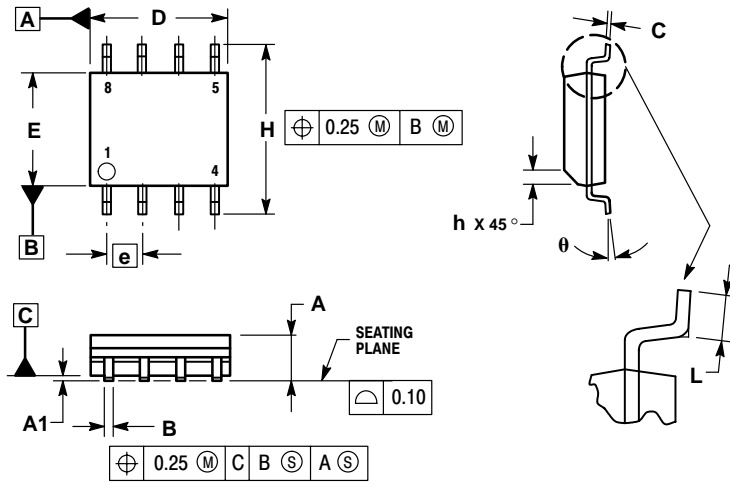

Figure 22. Typical Solder Heating Profile

NTMSD2P102LR2

PACKAGE DIMENSIONS

SO-8
CASE 751-06
ISSUE T



NOTES:

1. DIMENSIONING AND TOLERANCING PER ASME Y14.5M, 1994.
2. DIMENSIONS ARE IN MILLIMETER.
3. DIMENSION D AND E DO NOT INCLUDE MOLD PROTRUSION.
4. MAXIMUM MOLD PROTRUSION 0.15 PER SIDE.
5. DIMENSION B DOES NOT INCLUDE DAMBAR PROTRUSION. ALLOWABLE DAMBAR PROTRUSION SHALL BE 0.127 TOTAL IN EXCESS OF THE B DIMENSION AT MAXIMUM MATERIAL CONDITION.

MILLIMETERS		
DIM	MIN	MAX
A	1.35	1.75
A1	0.10	0.25
B	0.35	0.49
C	0.19	0.25
D	4.80	5.00
E	3.80	4.00
e	1.27 BSC	
H	5.80	6.20
h	0.25	0.50
L	0.40	1.25
θ	0°	7°

STYLE 18:

- PIN 1: ANODE
 2. ANODE
 3. SOURCE
 4. GATE
 5. DRAIN
 6. DRAIN
 7. CATHODE
 8. CATHODE

FETKY is a trademark of International Rectifier

ON Semiconductor and  are trademarks of Semiconductor Components Industries, LLC (SCILLC). SCILLC reserves the right to make changes without further notice to any products herein. SCILLC makes no warranty, representation or guarantee regarding the suitability of its products for any particular purpose, nor does SCILLC assume any liability arising out of the application or use of any product or circuit, and specifically disclaims any and all liability, including without limitation special, consequential or incidental damages. "Typical" parameters which may be provided in SCILLC data sheets and/or specifications can and do vary in different applications and actual performance may vary over time. All operating parameters, including "Typicals" must be validated for each customer application by customer's technical experts. SCILLC does not convey any license under its patent rights nor the rights of others. SCILLC products are not designed, intended, or authorized for use as components in systems intended for surgical implant into the body, or other applications intended to support or sustain life, or for any other application in which the failure of the SCILLC product could create a situation where personal injury or death may occur. Should Buyer purchase or use SCILLC products for any such unintended or unauthorized application, Buyer shall indemnify and hold SCILLC and its officers, employees, subsidiaries, affiliates, and distributors harmless against all claims, costs, damages, and expenses, and reasonable attorney fees arising out of, directly or indirectly, any claim of personal injury or death associated with such unintended or unauthorized use, even if such claim alleges that SCILLC was negligent regarding the design or manufacture of the part. SCILLC is an Equal Opportunity/Affirmative Action Employer.

PUBLICATION ORDERING INFORMATION

NORTH AMERICA Literature Fulfillment:

Literature Distribution Center for ON Semiconductor
P.O. Box 5163, Denver, Colorado 80217 USA
Phone: 303-675-2175 or 800-344-3860 Toll Free USA/Canada
Fax: 303-675-2176 or 800-344-3867 Toll Free USA/Canada
Email: ONlit@hibbertco.com
Fax Response Line: 303-675-2167 or 800-344-3810 Toll Free USA/Canada

N. American Technical Support: 800-282-9855 Toll Free USA/Canada

EUROPE: LDC for ON Semiconductor – European Support

German Phone: (+1) 303-308-7140 (Mon-Fri 2:30pm to 7:00pm CET)
Email: ONlit-german@hibbertco.com
French Phone: (+1) 303-308-7141 (Mon-Fri 2:00pm to 7:00pm CET)
Email: ONlit-french@hibbertco.com
English Phone: (+1) 303-308-7142 (Mon-Fri 12:00pm to 5:00pm GMT)
Email: ONlit@hibbertco.com

EUROPEAN TOLL-FREE ACCESS*: 00-800-4422-3781

*Available from Germany, France, Italy, UK, Ireland

CENTRAL/SOUTH AMERICA:

Spanish Phone: 303-308-7143 (Mon-Fri 8:00am to 5:00pm MST)
Email: ONlit-spanish@hibbertco.com
Toll-Free from Mexico: Dial 01-800-288-2872 for Access –
then Dial 866-297-9322

ASIA/PACIFIC: LDC for ON Semiconductor – Asia Support

Phone: 303-675-2121 (Tue-Fri 9:00am to 1:00pm, Hong Kong Time)
Toll Free from Hong Kong & Singapore:
001-800-4422-3781

Email: ONlit-asia@hibbertco.com

JAPAN: ON Semiconductor, Japan Customer Focus Center

4-32-1 Nishi-Gotanda, Shinagawa-ku, Tokyo, Japan 141-0031
Phone: 81-3-5740-2700
Email: r14525@onsemi.com

ON Semiconductor Website: <http://onsemi.com>

For additional information, please contact your local Sales Representative.