

7-line IPAD™, EMI filter and ESD protection

Features

- High attenuation in the mobile frequency range (typically better than -40 dB from 900 MHz to 2 GHz)
- Very low clamping voltage
- Low line capacitance (30 pF max) suitable for high-speed interfaces
- Maximum rise and fall time: 6 ns (10% - 90%)
- Compliant with high speed data rate
- Lead-free Flip-Chip package in 400 µm pitch
- Very thin package: 0.6 mm thickness

Benefits

- High efficiency in EMI filtering
- High bandwidth: typically 200 MHz at -3 dB
- 80% space saving versus discrete solution (BOM reduction)
- High reliability offered by monolithic integration
- High reduction of parasitic elements through integration and wafer level packaging

Complies with the following standards

- IEC 61000-4-2 level 4 on inputs and outputs:
 - 15 kV (air discharge)
 - 8 kV (contact discharge)

Applications

Displays and cameras where EMI filtering in ESD sensitive equipment is required:

- Mobile phones and PDAs
- Personal and home entertainment (portable Audio, DVD players, LCD TVs)
- Portable navigation devices
- Digital still cameras
- Portable gaming systems

TM: IPAD is a trademark of STMicroelectronics.

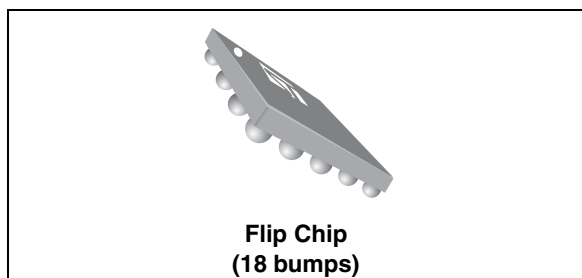

Description

The EMIF07-LCD03F3 is a 7-line highly integrated L/C filter designed to suppress EMI/RFI noise in all systems subjected to electromagnetic interference.

The EMIF07-LCD03F3 Flip-Chip packaging means the package size is equal to the die size.

This LC filter includes ESD protection circuitry, which prevents damage to the protected device when subjected to ESD surges up to ±15 kV.

Figure 1. Pin layout (bump side)

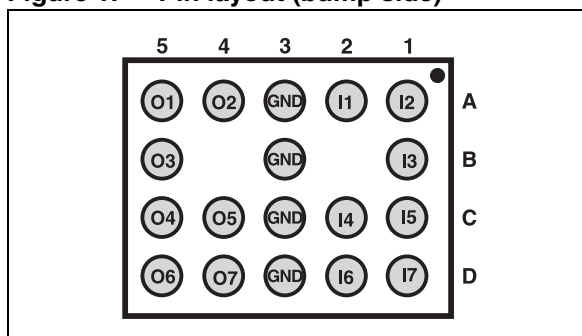
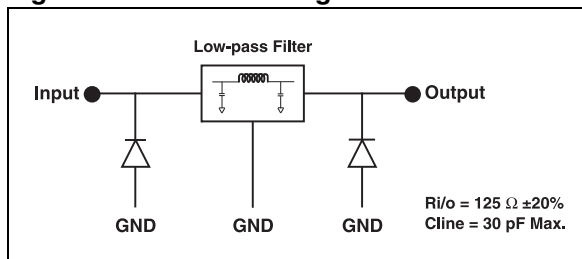

Figure 2. Device configuration



1 Characteristics

Table 1. Absolute maximum ratings ($T_{amb} = 25\text{ }^{\circ}\text{C}$)

Symbol	Parameter and test conditions	Value	Unit
V_{pp}	Input and output pins:		
	ESD discharge IEC 610000-4-2, air discharge	± 15	kV
	ESD discharge IEC 610000-4-2, contact discharge	± 15	
T_j	Maximum junction temperature	125	$^{\circ}\text{C}$
T_{op}	Operating temperature range	-40 to +85	$^{\circ}\text{C}$
T_{stg}	Storage temperature range	-55 to 150	$^{\circ}\text{C}$

Table 2. Electrical characteristics ($T_{amb} = 25\text{ }^{\circ}\text{C}$)

Symbol	Parameters				
V_{BR}	Breakdown voltage				
I_{RM}	Leakage current @ V_{RM}				
V_{RM}	Stand-off voltage				
$R_{I/O}$	Series resistance between input and output				
C_{line}	Line capacitance				
Symbol	Test conditions	Min	Typ	Max	Unit
V_{BR}	$I_R = 1\text{ mA}$	14			V
I_{RM}	$V_{RM} = 3\text{ V per line}$			200	nA
$R_{I/O}$	Tolerance $\pm 20\%$	100	125	150	Ω
C_{line}	$V_{line} = 0\text{ V}, V_{OSC} = 30\text{ mV}, F = 1\text{ MHz}$			30	pF

Figure 3. Attenuation versus frequency (all GND bumps connected)

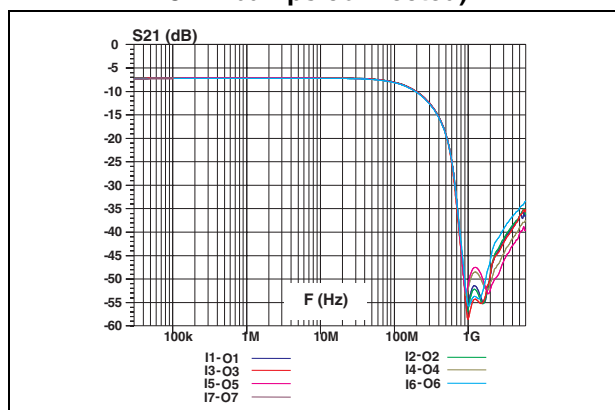

Figure 4. Analog cross talk versus frequency (all GND bumps connected)

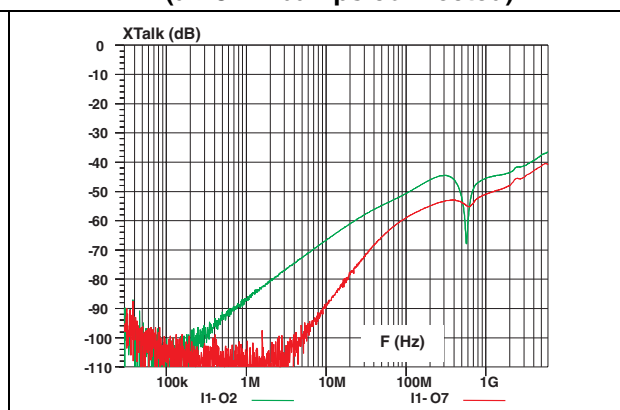

Figure 5. ESD response under IEC61000-4-2 conditions, VPP = +15 kV air discharge

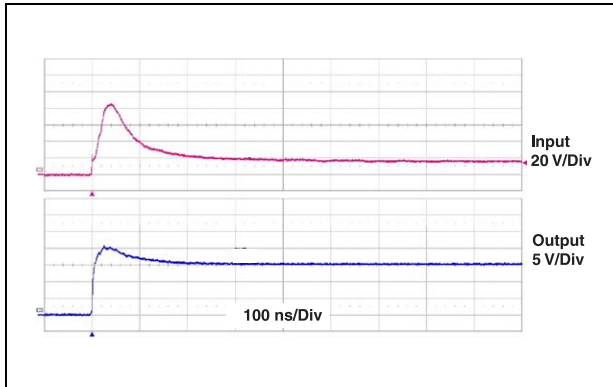

Figure 6. ESD response under IEC61000-4-2 conditions, VPP = -15 kV air discharge

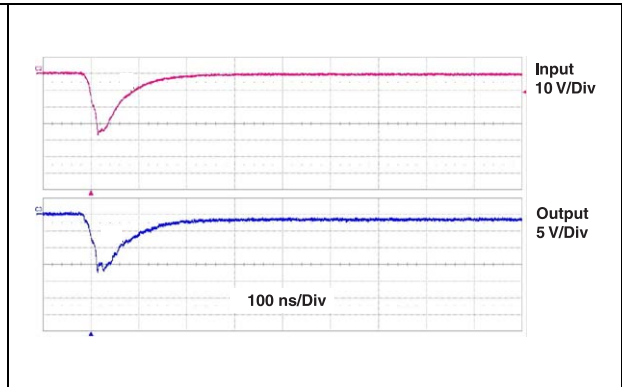

Figure 7. Line capacitance versus applied voltage

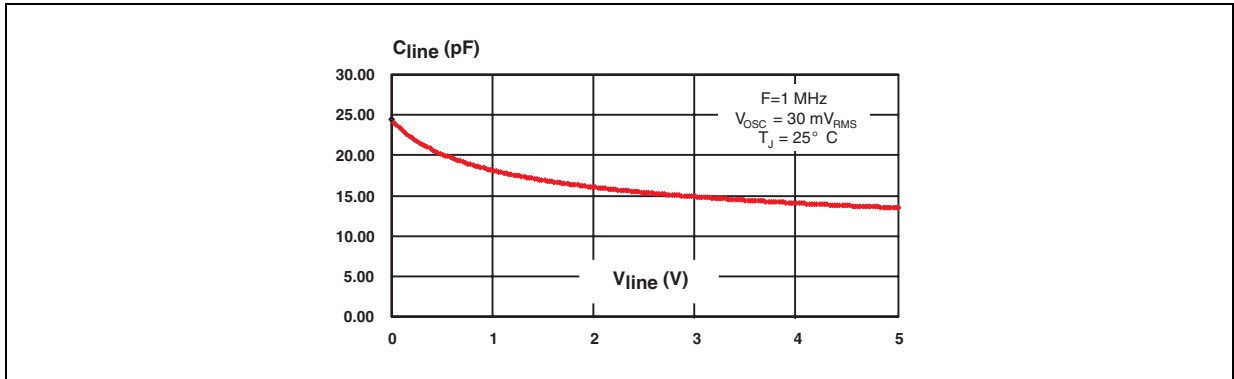

Figure 8. Typical rise and fall time: input voltage

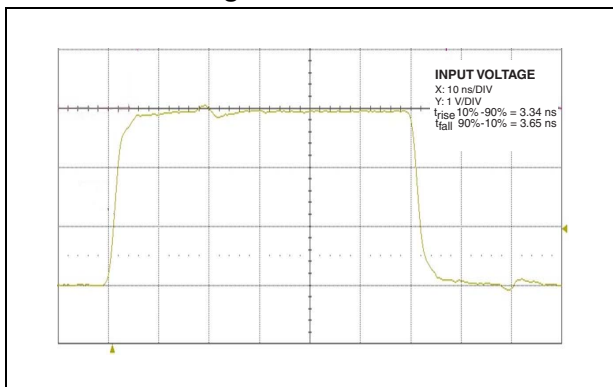
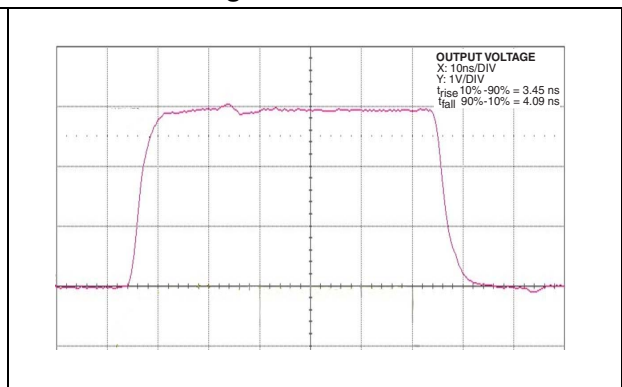
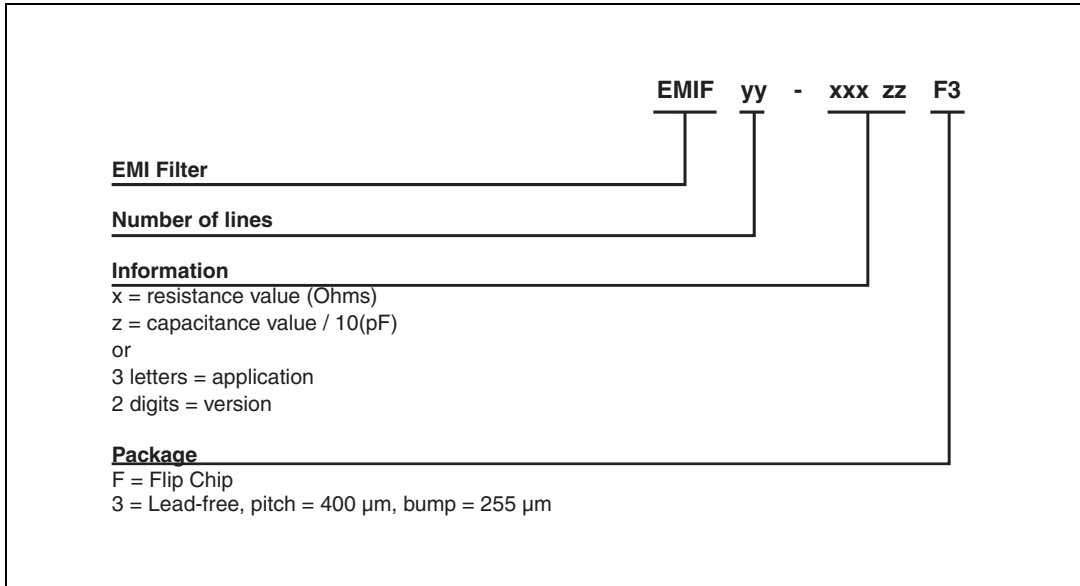

Figure 9. Typical rise and fall time: output voltage



2 Ordering information scheme

Figure 10. Ordering information scheme



3 Package information

In order to meet environmental requirements, ST offers these devices in different grades of ECOPACK® packages, depending on their level of environmental compliance. ECOPACK® specifications, grade definitions and product status are available at: www.st.com. ECOPACK® is an ST trademark.

Figure 11. Package dimensions

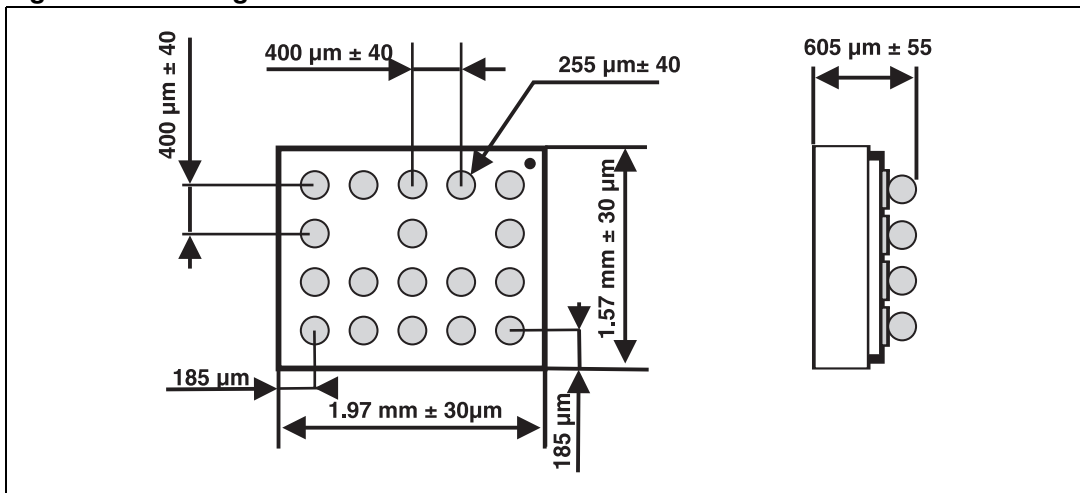

Figure 12. Footprint

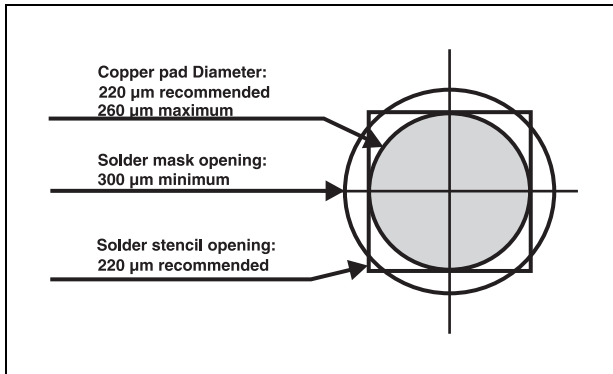

Figure 13. Marking

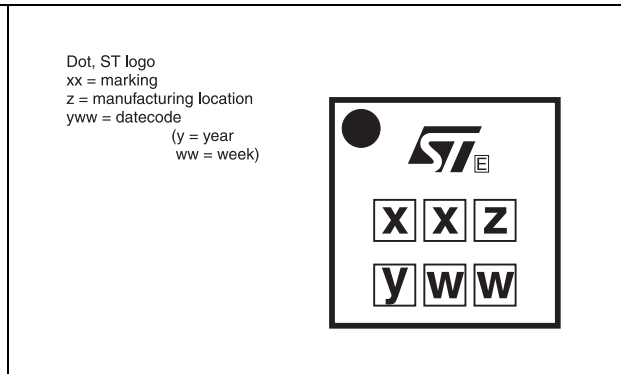
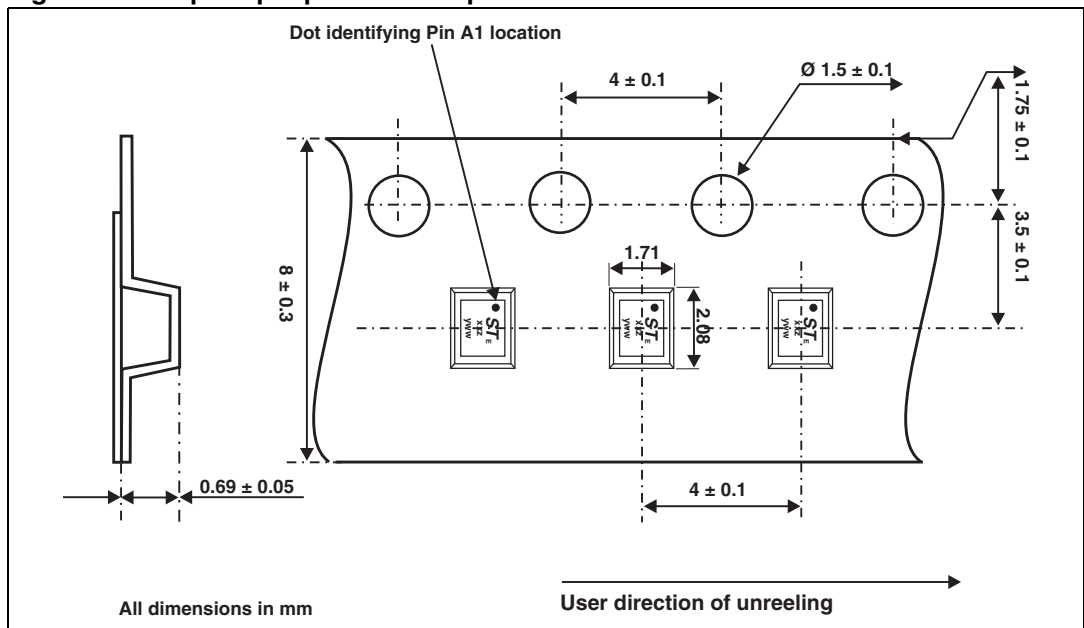

Figure 14. Flip Chip tape and reel specification



Note:

More information is available in the application notes:

AN2348: “STMicroelectronics 400 micro-metre Flip Chip: Package description and recommendation for use”

AN1751: “EMI filters: Recommendations and measurements”

4 Ordering information

Table 3. Ordering information

Order code	Marking	Package	Weight	Base qty	Delivery mode
EMIF07-LCD03F3	HW	Flip Chip	4 mg	5000	Tape and reel 7”

5 Revision history

Table 4. Document revision history

Date	Revision	Changes
05-Dec-08	1	Initial release.

Please Read Carefully:

Information in this document is provided solely in connection with ST products. STMicroelectronics NV and its subsidiaries ("ST") reserve the right to make changes, corrections, modifications or improvements, to this document, and the products and services described herein at any time, without notice.

All ST products are sold pursuant to ST's terms and conditions of sale.

Purchasers are solely responsible for the choice, selection and use of the ST products and services described herein, and ST assumes no liability whatsoever relating to the choice, selection or use of the ST products and services described herein.

No license, express or implied, by estoppel or otherwise, to any intellectual property rights is granted under this document. If any part of this document refers to any third party products or services it shall not be deemed a license grant by ST for the use of such third party products or services, or any intellectual property contained therein or considered as a warranty covering the use in any manner whatsoever of such third party products or services or any intellectual property contained therein.

UNLESS OTHERWISE SET FORTH IN ST'S TERMS AND CONDITIONS OF SALE ST DISCLAIMS ANY EXPRESS OR IMPLIED WARRANTY WITH RESPECT TO THE USE AND/OR SALE OF ST PRODUCTS INCLUDING WITHOUT LIMITATION IMPLIED WARRANTIES OF MERCHANTABILITY, FITNESS FOR A PARTICULAR PURPOSE (AND THEIR EQUIVALENTS UNDER THE LAWS OF ANY JURISDICTION), OR INFRINGEMENT OF ANY PATENT, COPYRIGHT OR OTHER INTELLECTUAL PROPERTY RIGHT.

UNLESS EXPRESSLY APPROVED IN WRITING BY AN AUTHORIZED REPRESENTATIVE OF ST, ST PRODUCTS ARE NOT DESIGNED, AUTHORIZED OR WARRANTED FOR USE IN MILITARY, AIR CRAFT, SPACE, LIFE SAVING, OR LIFE SUSTAINING APPLICATIONS, NOR IN PRODUCTS OR SYSTEMS, WHERE FAILURE OR MALFUNCTION MAY RESULT IN PERSONAL INJURY, DEATH, OR SEVERE PROPERTY OR ENVIRONMENTAL DAMAGE. ST PRODUCTS WHICH ARE NOT SPECIFIED AS "AUTOMOTIVE GRADE" MAY ONLY BE USED IN AUTOMOTIVE APPLICATIONS AT USER'S OWN RISK.

Resale of ST products with provisions different from the statements and/or technical features set forth in this document shall immediately void any warranty granted by ST for the ST product or service described herein and shall not create or extend in any manner whatsoever, any liability of ST.

ST and the ST logo are trademarks or registered trademarks of ST in various countries.

Information in this document supersedes and replaces all information previously supplied.

The ST logo is a registered trademark of STMicroelectronics. All other names are the property of their respective owners.

© 2008 STMicroelectronics - All rights reserved

STMicroelectronics group of companies

Australia - Belgium - Brazil - Canada - China - Czech Republic - Finland - France - Germany - Hong Kong - India - Israel - Italy - Japan - Malaysia - Malta - Morocco - Singapore - Spain - Sweden - Switzerland - United Kingdom - United States of America

www.st.com

