

# PRODUCT SPECIFICATION

DATE : 02/02/2012

<b>cosmo</b> ELECTRONICS CORPORATION	Photocoupler : <b>KMOC3012S</b>	NO.61P48001	REV.
		SHEET 1 OF 6	3

## Zero Crossing Optoisolators TRIAC Driver Output (600V Volts Peak)

### ● Features

1. Pb free and RoHS Compliant.
2. Compact surface mount type package.
3. 600V peak blocking voltage.
4. Isolation voltage between input and output (Viso : 5300Vrms).
5. Safety Approval :  
UL approved : No.E169586  
CUL approved : No.E169586  
VDE approved : No.101347

### ● For 115/240 Vac(rms) Application :

1. Solenoid/Valve Controls.
2. Lighting Controls.
3. Static Power Switches.
4. AC Motor Drives.
5. Temperature Controls.
6. E.M. Contactors.
7. AC Motor Starters.
8. Solid State Relays.
9. Programmable controllers.

# PRODUCT SPECIFICATION

DATE : 02/02/2012

<b>cosmo</b> ELECTRONICS CORPORATION	Photocoupler : <b>KMOC3012S</b>	NO.61P48001	REV. 3
		SHEET 2 OF 6	

## 1. OUTSIDE DIMENSION : UNIT (mm)

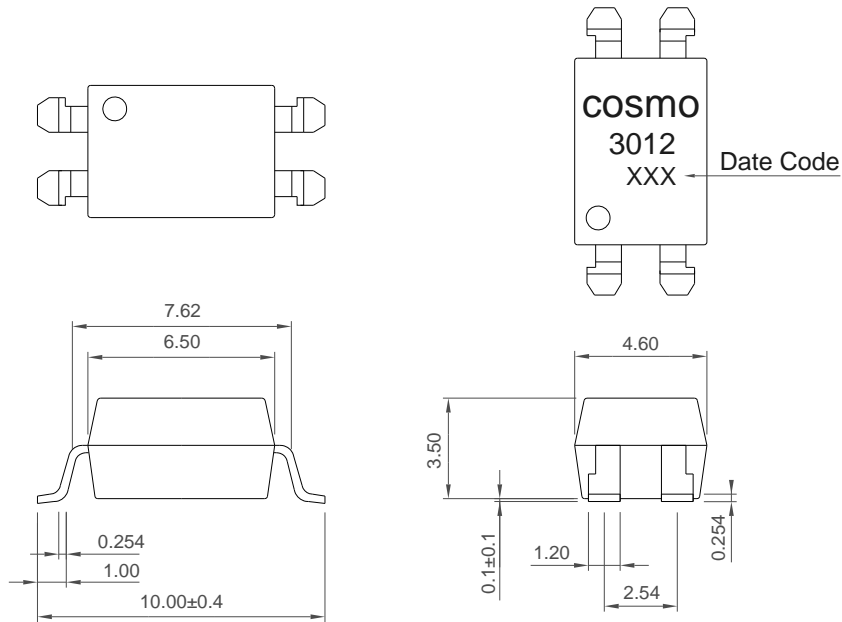

TOLERANCE : ±0.2mm

## 2. SCHEMATIC : TOP VIEW

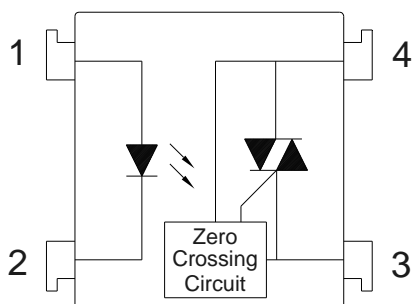

1. Anode
2. Cathode
3. Main Terminal
4. Main Terminal

# PRODUCT SPECIFICATION

DATE : 02/02/2012

<b>cosmo</b> ELECTRONICS CORPORATION	Photocoupler : <b>KMOC3012S</b>	NO.61P48001	REV. 3
		SHEET 3 OF 6	

## ● Absolute Maximum Ratings

Parameter		Symbol	Rating	Unit
Input	Forward current	I <sub>F</sub>	50	mA
	Peak forward current	I <sub>FM</sub>	1	A
	Reverse voltage	V <sub>R</sub>	6	V
	Power dissipation	P <sub>D</sub>	70	mW
Output	Off-State Output Terminal voltage	V <sub>DRM</sub>	600	V <sub>PEAK</sub>
	On-State R.M.S. Current	I <sub>T(RMS)</sub>	100	mA
	Peak Repetitive Surge Current (PW=10ms.DC 10%)	I <sub>TSM</sub>	1	A
	Power dissipation	P <sub>D</sub>	300	mW
Total power dissipation		P <sub>tot</sub>	330	mW
Isolation voltage 1 minute		V <sub>iso</sub>	5300	V <sub>rms</sub>
Operating temperature		T <sub>opr</sub>	-40 to +100	°C
Storage temperature		T <sub>stg</sub>	-55 to +125	°C
Soldering temperature 10 second		T <sub>sol</sub>	260	°C

## ● Electro-optical Characteristics

Parameter		Symbol	Conditions	Min.	Typ.	Max.	Unit
Input	Forward voltage	V <sub>F</sub>	I <sub>F</sub> =10mA	-	1.2	1.4	V
	Reverse current	I <sub>R</sub>	V <sub>R</sub> =6V	-	-	10	uA
Output	Peak Blocking Current	I <sub>DRM</sub>	V <sub>DRM</sub> =600V	-	-	500	nA
	ON-State Voltage	V <sub>TM</sub>	I <sub>TM</sub> =100mA	-	1.6	3	V
Transfer characteristics	Holding Current	I <sub>H</sub>		-	0.1	-	mA
	Critical rate of rise of OFF-state voltage	dV/dt	V <sub>DRM</sub> =(1/√2)*Rated	600	-	-	V/uS
	Inhibit Voltage (MT1-MT2 Voltage above which device not trigger.)	V <sub>INH</sub>	I <sub>F</sub> =10mA	-	10	20	V
	Leakage in Inhibited State	I <sub>DRM2</sub>	I <sub>F</sub> =Rated I <sub>FT</sub> , Rated V <sub>DRM</sub> , Off State	-	-	500	uA
	Isolation resistance	R <sub>iso</sub>	DC500V	5x10 <sup>10</sup>	10 <sup>11</sup>	-	Ohm
Minimum trigger current		I <sub>FT</sub>	Main Terminal Voltage=3V	-	-	10	mA

# PRODUCT SPECIFICATION

DATE : 02/02/2012

**cosmo**  
ELECTRONICS CORPORATION

Photocoupler :  
**KMOC3012S**

NO.61P48001  
SHEET 4 OF 6

REV.  
3

Fig.1 Forward Current vs. Ambient Temperature

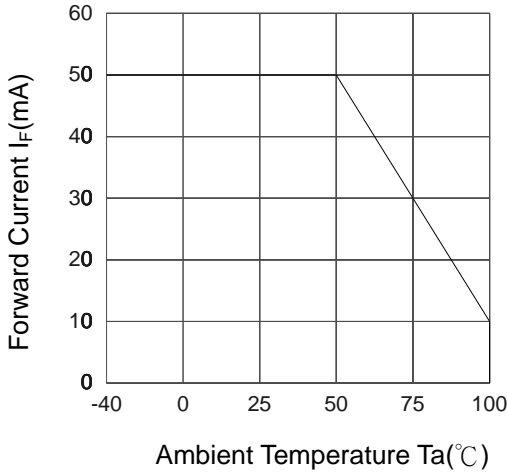

Fig.2 On-State Voltage vs. Ambient Temperature

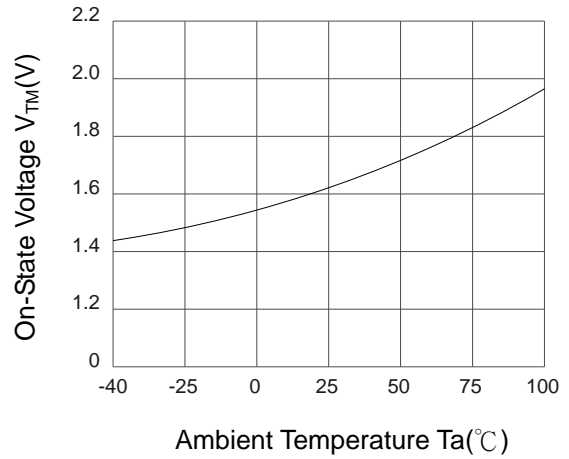

Fig.3 On-State R.M.S. Current vs. Ambient Temperature

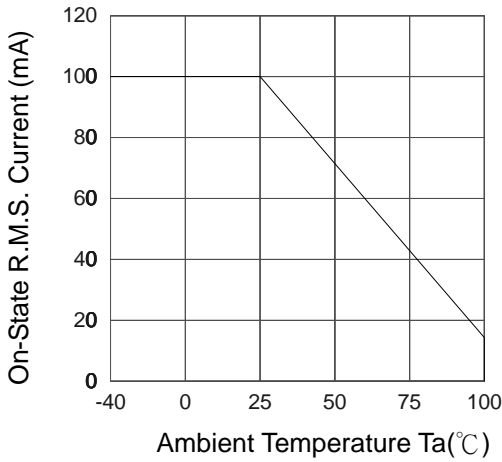

Fig.4 Holding Current vs. Ambient Temperature

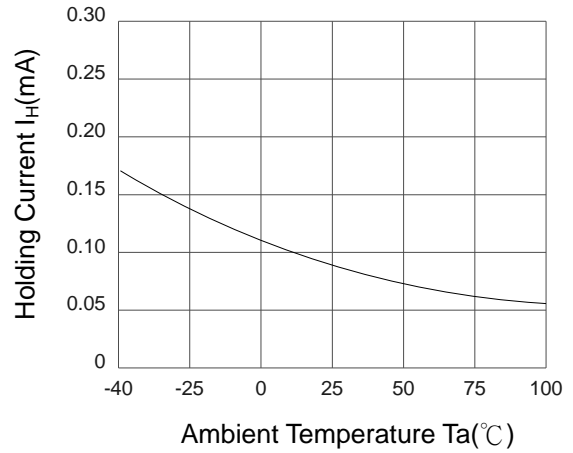

Fig.5 Peak Forward Current vs. Duty Ratio

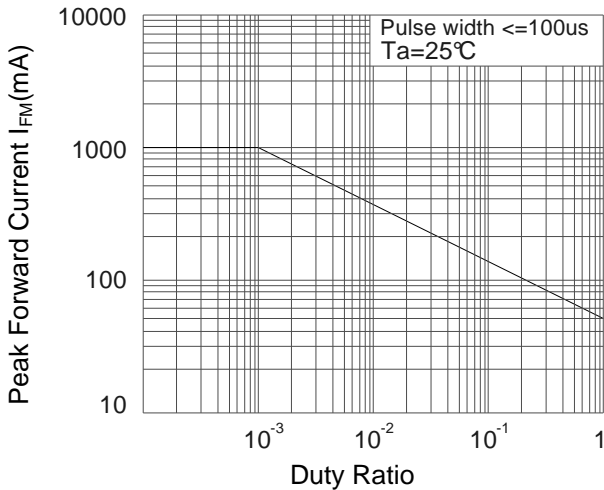
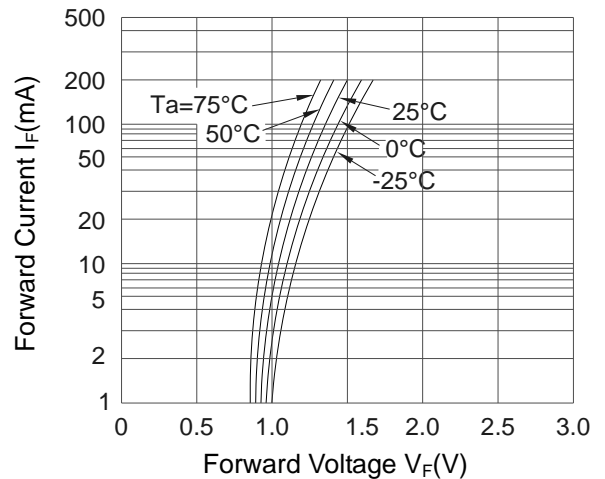

Fig.6 Forward Current vs. Forward Voltage



# PRODUCT SPECIFICATION

DATE : 02/02/2012

**cosmo**  
ELECTRONICS CORPORATION

Photocoupler :  
**KMOC3012S**

NO.61P48001  
SHEET 5 OF 6

REV.  
3

Fig.7 Trigger Current vs. Ambient Temperature

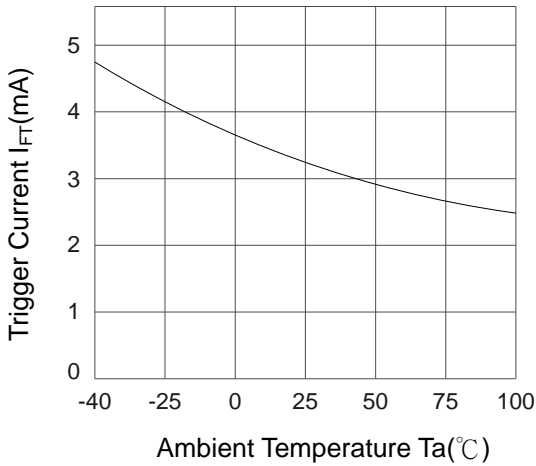

Fig.8 Inhibit Voltage vs. Ambient Temperature

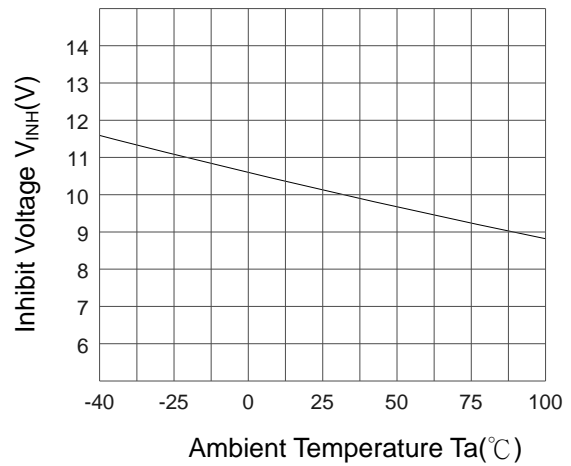

Fig.9 Leakage with LED off vs. Ambient Temperature

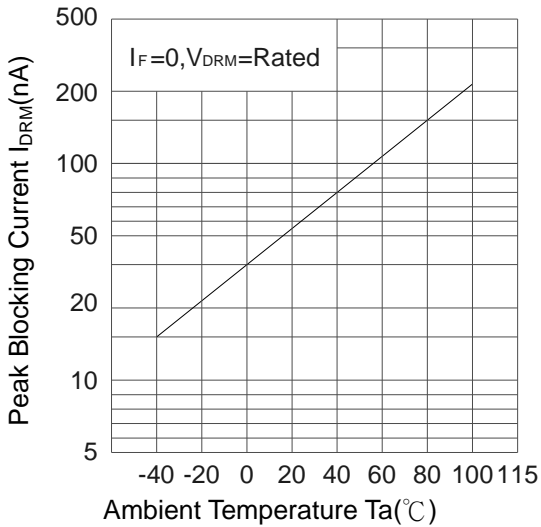
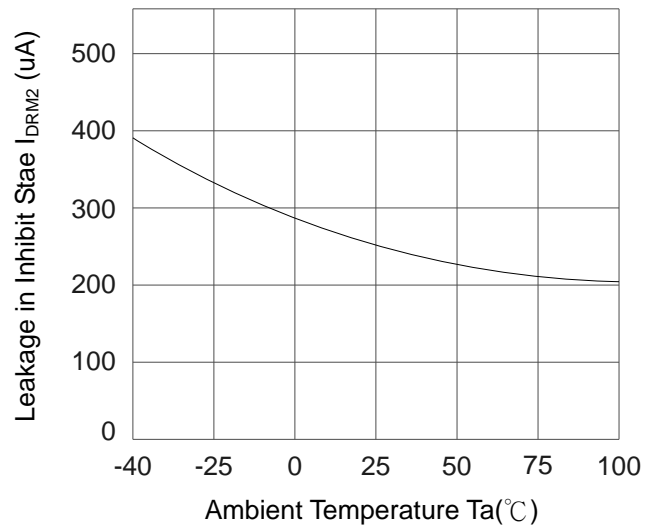

Fig.10 I<sub>DRM2</sub>, Leakage in Inhibit State vs. Ambient Temperature



# PRODUCT SPECIFICATION

DATE : 02/02/2012

<b>cosmo</b> ELECTRONICS CORPORATION	Photocoupler : <b>KMOC3012S</b>	NO.61P48001	REV.
		SHEET 6 OF 6	3

## NOTICE

The information contained in this document is intended to be a general product description and is subject to change without notice. Please contact cosmo in order to obtain the latest device data sheets before using any cosmo device. cosmo does not assume any responsibility for use of any circuitry described. No circuit patent licenses are implied. This publication is the property of cosmo . No part of this publication may be reproduced or copied in any form or by any means, or transferred to any third party without the prior written consent of cosmo Electronics Corporation.

The devices listed in this document are designed for general applications only in electronic equipment. No devices shall be deployed which require higher level of reliability such as :

- Medical and other life support equipments.
- Space application.
- Telecommunication equipment (trunk lines).
- Nuclear power control equipment.

Unless it received prior written approval from cosmo.

cosmo takes no responsibility for damages arise form the improper usage of our device. Please contact cosmo for further information regarding the above notices.