

## FEATURES

- Complete Step-Down Switch Mode Power Supply
- Wide Input Voltage Range: 4V to 36V
- 1.25V to 5V Output Voltage
- EN55022 Class B Compliant
- 200mA Output Current
- Current Mode Control
- -55°C to 125°C Operating Temperature (LTM8020MPV)
- Pb-Free (e4) RoHS Compliant Package with Gold Pad Finish
- Tiny, Low Profile (6.25mm × 6.25mm × 2.32mm) Surface Mount LGA Package

## APPLICATIONS

- Automotive Battery Regulation
- Power for Portable Products
- Distributed Supply Regulation
- Industrial Supplies
- Wall Transformer Regulation

## DESCRIPTION

The LTM<sup>®</sup>8020 is a complete 200mA, DC/DC step-down power supply. Included in the package are the switching controller, power switches, inductor, and all support components. Operating over an input voltage range of 4V to 36V, the LTM8020 supports an output voltage range of 1.25V to 5V, set by a single resistor. Only bulk capacitors are needed to finish the design. The LTM8020 meets the radiated emissions requirements of EN55022. Conducted emission requirements can be met by adding standard filter components.

The low profile (2.32mm) tiny package enables utilization of unused space on the bottom of PC boards for high density point of load regulation.

The LTM8020 is packaged in a thermally enhanced, compact (6.25mm × 6.25mm) and low profile (2.32mm) over-molded land grid array (LGA) package suitable for automated assembly by standard surface mount equipment. The LTM8020 is Pb-free and RoHS compliant.

LT, LT, LTC, LTM, μModule, Linear Technology, the Linear logo and Burst Mode are registered trademarks of Linear Technology Corporation. All other trademarks are the property of their respective owners.

## TYPICAL APPLICATION

### 6.5V<sub>IN</sub> to 36V<sub>IN</sub>, 5V at 200mA DC/DC μModule<sup>®</sup> Regulator

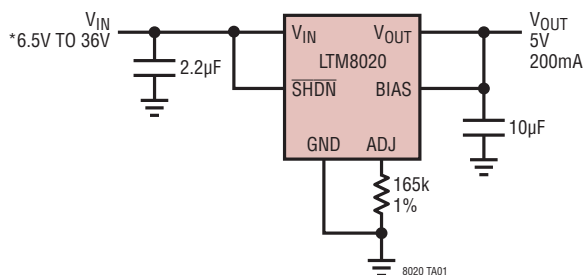

\*RUNNING VOLTAGE RANGE. PLEASE REFER TO APPLICATIONS INFORMATION FOR START-UP DETAILS

### Efficiency and Power Loss vs Load Current

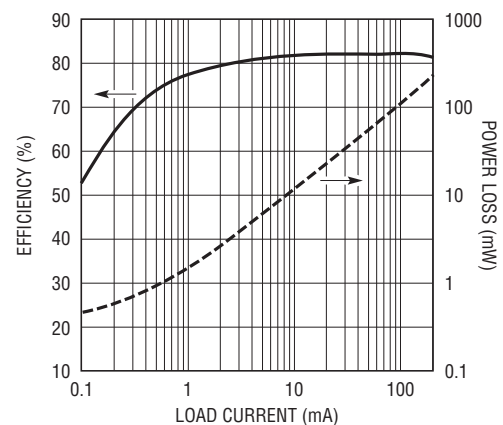

3470 TA01b

## ABSOLUTE MAXIMUM RATINGS

(Note 1)

$V_{IN}$ , SHDN Voltage .....	40V
ADJ Voltage .....	5V
BIAS Voltage .....	25V
$V_{IN}$ + BIAS Voltage .....	47V
$V_{OUT}$ Voltage .....	10V
Internal Operating Temperature Range ..	-40°C to 125°C
Storage Temperature Range .....	-55°C to 125°C
Maximum Solder Temperature.....	260°C

## PIN CONFIGURATION

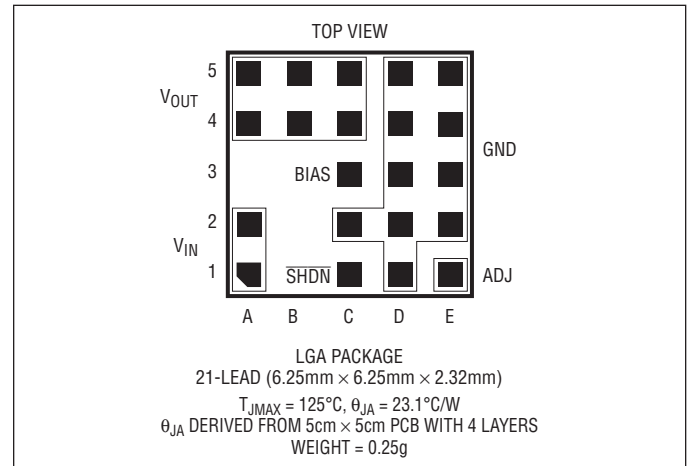

## ORDER INFORMATION

LEAD FREE FINISH	PART MARKING*	PACKAGE DESCRIPTION	TEMPERATURE RANGE (Note 2)
LTM8020EV#PBF	LTM8020V	21-Lead (6.25mm × 6.25mm)	-40°C to 85°C
LTM8020IV#PBF	LTM8020V	21-Lead (6.25mm × 6.25mm)	-40°C to 85°C
LTM8020MPV#PBF	LTM8020MPV	21-Lead (6.25mm × 6.25mm)	-55°C to 125°C

Consult LTC Marketing for parts specified with wider operating temperature ranges. \*The temperature grade is identified by a label on the shipping container.

For more information on lead free part marking, go to: <http://www.linear.com/leadfree/>

This product is only offered in trays. For more information go to: <http://www.linear.com/packaging/>

**ELECTRICAL CHARACTERISTICS** The ● denotes the specifications which apply over the full operating temperature range, otherwise specifications are at  $T_A = 25^\circ\text{C}$ .  $V_{IN} = 10\text{V}$ ,  $V_{SHDN} = 10\text{V}$ ,  $V_{BIAS} = 3\text{V}$ , External  $C_{IN} = 2.2\mu\text{F}$ ,  $C_{OUT} = 4.7\mu\text{F}$ . (Note 2)

SYMBOL	PARAMETER	CONDITIONS	MIN	TYP	MAX	UNITS
$V_{IN}$	Input DC Voltage		4		36	V
$V_{OUT}$	Output DC Voltage	$0 < I_{OUT} \leq 200\text{mA}$ ; $167\text{k}\Omega < R_{ADJ} < \infty$	1.2		5	V
$R_{ADJ(MIN)}$	Minimum Allowable $R_{ADJ}$	(Note 3)	163			k $\Omega$
$I_{LK}$	Leakage from IN to OUT	$V_{SHDN} = 0\text{V}$ , $BIAS = 0\text{V}$		1.2	6	$\mu\text{A}$
$I_{OUT}$	Continuous Output DC Current	$5.5\text{V} \leq V_{IN} \leq 36\text{V}$ , $R_{ADJ} = 301\text{k}$ , $V_O = 3.3\text{V}$	0		200	mA
$I_{Q(VIN)}$	Quiescent Current into IN	$\overline{SHDN} = 0.2\text{V}$ , BIAS Open BIAS = 3V, Not Switching BIAS = 0V, Not Switching		10	1	$\mu\text{A}$ $\mu\text{A}$ $\mu\text{A}$
$I_{Q(BIAS)}$	Quiescent Current into BIAS	$\overline{SHDN} = 0.2\text{V}$ , BIAS = 0V BIAS = 3V, Not Switching BIAS = 0V, Not Switching		25	0.5	$\mu\text{A}$ $\mu\text{A}$ $\mu\text{A}$
$\Delta V_{OUT}/V_{OUT}$	Line Regulation	$5\text{V} \leq V_{IN} \leq 36\text{V}$ , $I_{OUT} = 200\text{mA}$ , $R_{ADJ}$ Open		1		%
$\Delta V_{OUT}/V_{OUT}$	Load Regulation	$V_{IN} = 24\text{V}$ , $0 \leq I_{OUT} \leq 200\text{mA}$ , $V_{OUT} = 3.3\text{V}$		2		%

**ELECTRICAL CHARACTERISTICS** The ● denotes the specifications which apply over the full operating temperature range, otherwise specifications are at  $T_A = 25^\circ\text{C}$ .  $V_{IN} = 10\text{V}$ ,  $V_{SHDN} = 10\text{V}$ ,  $V_{BIAS} = 3\text{V}$ , External  $C_{IN} = 2.2\mu\text{F}$ ,  $C_{OUT} = 4.7\mu\text{F}$ . (Note 2)

SYMBOL	PARAMETER	CONDITIONS	MIN	TYP	MAX	UNITS
$V_{OUT(AC\_RMS)}$	Output Ripple (RMS)	$I_{OUT} = 100\text{mA}$ , $V_{OUT} = 3.3\text{V}$ , $V_{IN} = 24\text{V}$		7.5		mV
$f_{SW}$	Switching Frequency	$I_{OUT} = 200\text{mA}$		450		kHz
$I_{SC}$	Output Short-Circuit Current	$V_{IN} = 36\text{V}$ , $V_{OUT} = 0\text{V}$		350		mA
$V_{ADJ}$	Voltage at ADJ Pin		● 1.228		1.265	V
$V_{BIAS(MIN)}$	Minimum BIAS Voltage for Proper Operation		● 3			V
$I_{ADJ}$	Current Out of ADJ Pin	$ADJ = 0\text{V}$ , $V_{OUT} = 5\text{V}$ , $V_{SHDN} = 0\text{V}$	● 9.65		10.35	$\mu\text{A}$
$I_{SHDN}$	SHDN Pin Current	$V_{SHDN} = 2.5\text{V}$		1	5	$\mu\text{A}$
$V_{IH(SHDN)}$	SHDN Input High Voltage		2.5			V
$V_{IL(SHDN)}$	SHDN Input Low Voltage				0.2	V

**Note 1:** Stresses beyond those listed under Absolute Maximum Ratings may cause permanent damage to the device. Exposure to any Absolute Maximum Rating condition for extended periods may affect device reliability and lifetime.

**Note 2:** The LTM8020E is guaranteed to meet performance specifications from  $0^\circ\text{C}$  to  $85^\circ\text{C}$  ambient. Specifications over the full  $-40^\circ\text{C}$  to  $85^\circ\text{C}$  ambient operating temperature range are assured by design, characterization and correlation with statistical process controls. The

LTM8020I is guaranteed to meet specifications over the full  $-40^\circ\text{C}$  to  $85^\circ\text{C}$  ambient operating temperature range. The LTM8020MP is guaranteed to meet specifications over the full  $-55^\circ\text{C}$  to  $125^\circ\text{C}$  internal operating temperature range. Note that the maximum internal temperature is determined by specific operating conditions in conjunction with board layout, the rated package thermal resistance and other environmental factors.

**Note 3:** Guaranteed by design.

**TYPICAL PERFORMANCE CHARACTERISTICS**  $T_A = 25^\circ\text{C}$  unless otherwise noted.

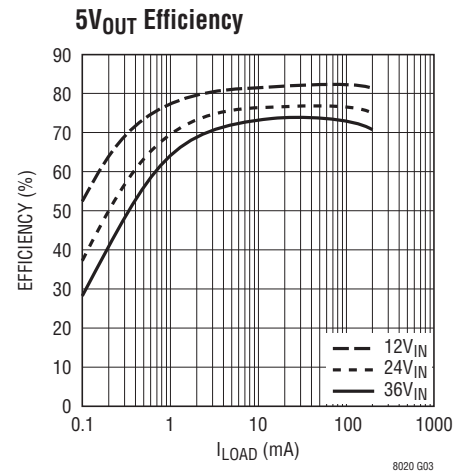
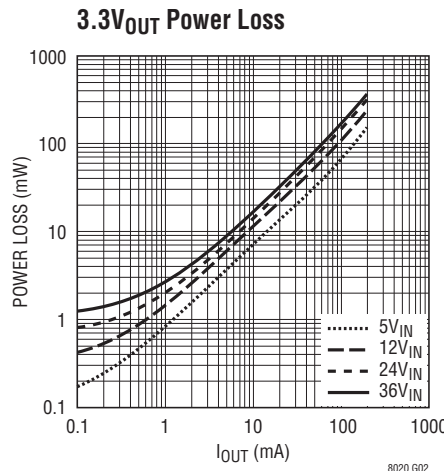
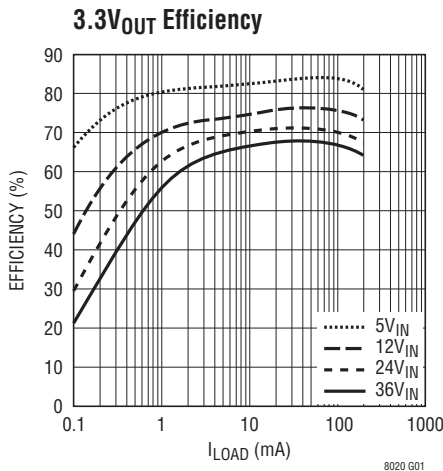

## TYPICAL PERFORMANCE CHARACTERISTICS $T_A = 25^\circ\text{C}$ unless otherwise noted.

**5V<sub>OUT</sub> Power Loss**

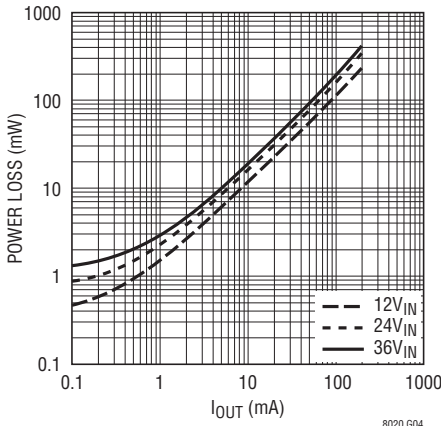

**Input Current vs Output Current (5V<sub>IN</sub>)**

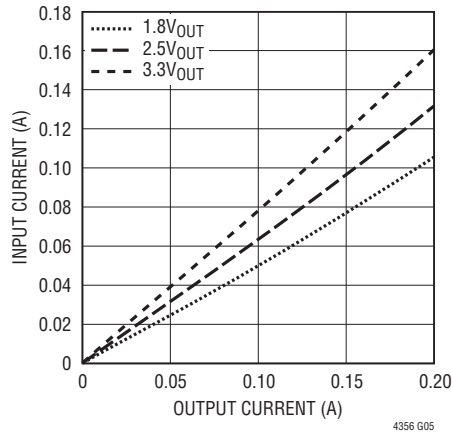

**Input Current vs Output Current (12V<sub>IN</sub>)**

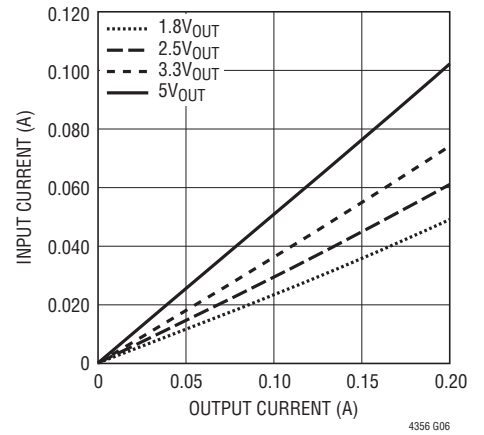

**Input Current vs Output Current (24V<sub>IN</sub>)**

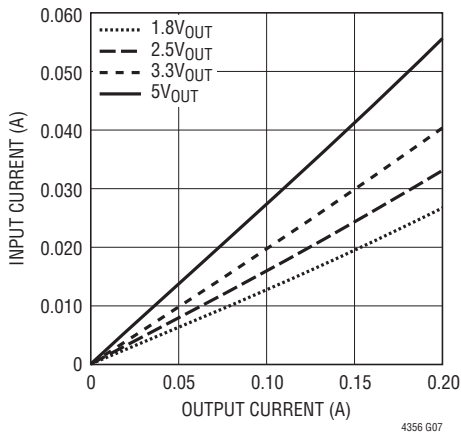

**Input Current vs Output Current (36V<sub>IN</sub>)**

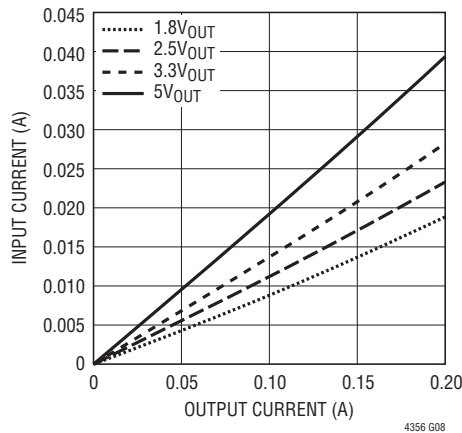

**Input Quiescent Current vs Input Voltage**

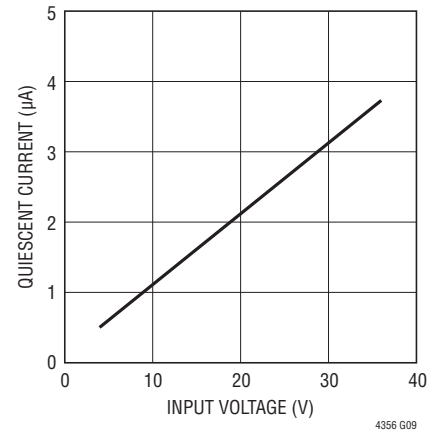

**Input Current vs Input Voltage (Output Short)**

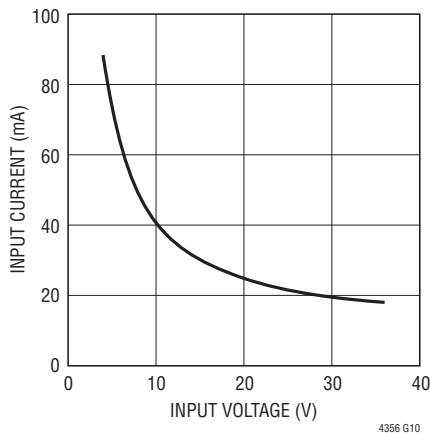

**Minimum Required Input Voltage vs Load (V<sub>OUT</sub> = 3.3V)**

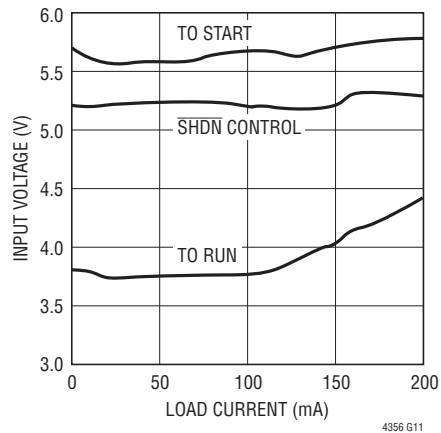

**Minimum Required Input Voltage vs Output Voltage**

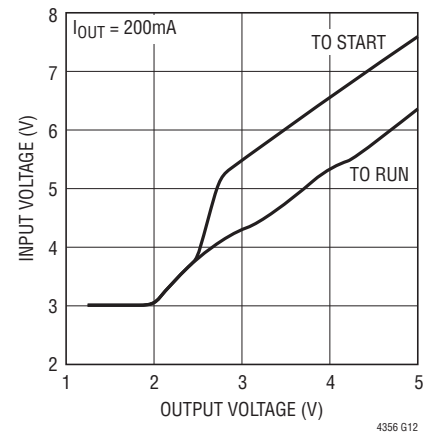

## TYPICAL PERFORMANCE CHARACTERISTICS $T_A = 25^\circ\text{C}$ unless otherwise noted.

Temperature Rise vs Input Voltage (Full Load,  $T_A = 25^\circ\text{C}$ )

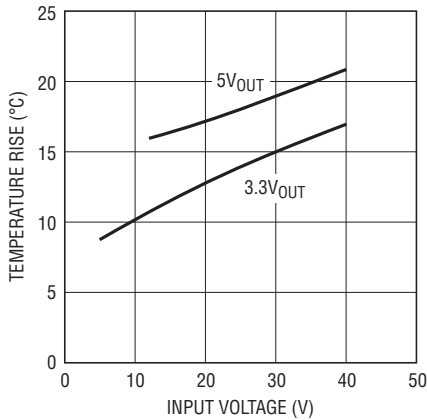

Turn-On Behavior ( $6V_{IN}$ ,  $3.3V_{OUT}$ , No Load)

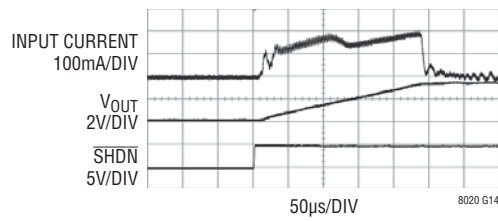

Radiated Emissions

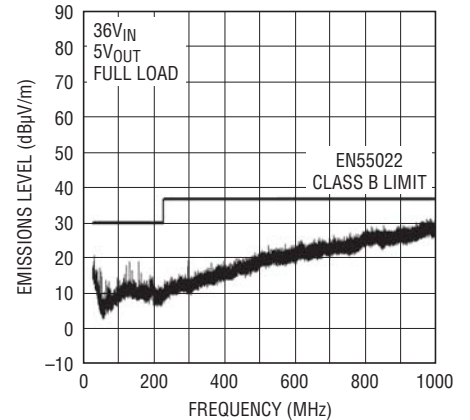

## PIN FUNCTIONS

**V<sub>IN</sub> (Pins A1, A2):** The V<sub>IN</sub> pins supply current to the LTM8020's internal regulator and to the internal power switch. These pins must be locally bypassed with an external, low ESR capacitor of at least 1µF.

**V<sub>OUT</sub> (Pins A4, A5, B4, B5, C4, C5):** Power Output Pins. An external capacitor is connected from V<sub>OUT</sub> to GND in most applications. Apply output load between these pins and GND.

**BIAS (Pin C3):** The BIAS pin connects to the internal boost Schottky diode and to the internal regulator. Tie to V<sub>OUT</sub> when V<sub>OUT</sub> > 3V or to another DC voltage greater than 3V otherwise. When BIAS > 3V the internal circuitry will be powered from this pin to improve efficiency. Main regulator power will still come from V<sub>IN</sub>.

**$\overline{\text{SHDN}}$  (Pin C1):** The  $\overline{\text{SHDN}}$  pin is used to put the LTM8020 in shutdown mode. Tie to ground to shut down the LTM8020. Apply 2V or more for normal operation. If the shutdown feature is not used, tie this pin to V<sub>IN</sub>.

**GND (Pins C2, D1, D2, D3, D4, D5, E2, E3, E4, E5):** The GND connections serve as the main signal return and the primary heat sink for the LTM8020. Tie the GND pins to a local ground plane below the LTM8020 and the circuit components. Return the feedback divider to this signal.

**ADJ (Pin E1):** The LTM8020 regulates its ADJ pin to 1.25V. Connect the adjust resistor from this pin to GND. The value of this adjust resistor is determined by the equation  $R_{ADJ} = 623.75 / (V_{OUT} - 1.25)$ , where R<sub>ADJ</sub> is in kΩ. Note that the ADJ pin is open circuit if V<sub>OUT</sub> = 1.25V.

**BLOCK DIAGRAM**

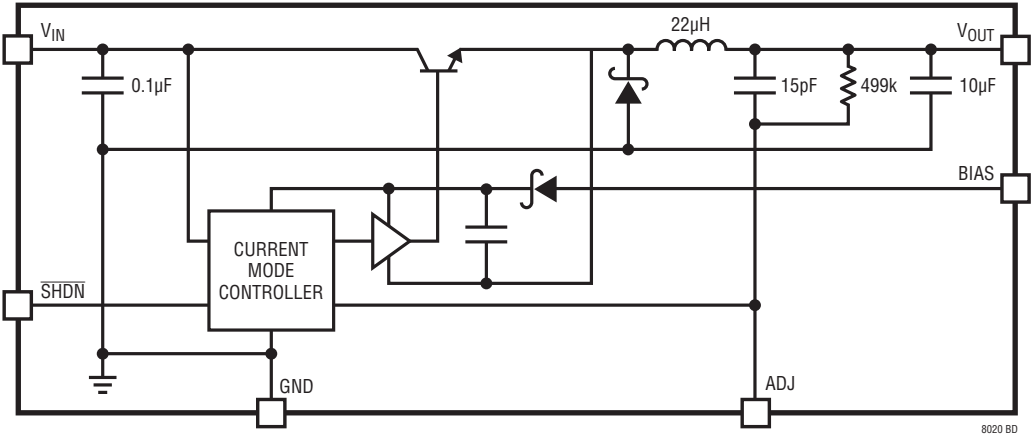

## OPERATION

The LTM8020 is a standalone nonisolated step-down switching DC/DC power supply. It can deliver up to 200mA of DC output current with only bulk external input and output capacitors. This module provides a precisely regulated output voltage programmable via one external resistor from 1.25VDC to 5VDC. The input voltage range is 4V to 36V. Given that the LTM8020 is a step-down converter, make sure that the input voltage is high enough to support the desired output voltage and load current. See Block Diagram.

The LTM8020 contains a current mode controller, power switching element, power inductor, power Schottky diode and a modest amount of input and output capacitance. For some applications, as shown in Table 1, no output capacitor is necessary.

With its high performance current mode controller and internal feedback loop compensation, the LTM8020 module has sufficient stability margin and good transient performance under a wide range of operating conditions with a wide range of output capacitors, even all ceramic ones (X5R or X7R). Current mode control provides cycle-by-cycle fast current limit, and automatic current limiting protects the module in the event of a short circuit or overload fault.

The LTM8020 is built upon a variable frequency controller. The on time, off time and switching frequency are dependent upon the input voltage, output voltage and load current.

The drive circuit for the internal power switching element is powered through the BIAS pin. Power this pin with at least 3V.

The LTM8020 is equipped with two operating modes, dependant upon the load current. When the load current is sufficiently high, the LTM8020 will switch continuously (see Figure 1a). If the load is very light, or if the input voltage is high relative to the output voltage, the part will operate in Burst Mode® operation, alternating between its micropower and switching states to keep the output in regulation and hold the power dissipation to a minimum (See Figure 1b).

If the  $\overline{\text{SHDN}}$  pin is grounded, all internal circuits are turned off and  $V_{\text{IN}}$  current reduces to the device leakage current, typically a few nanoamps.

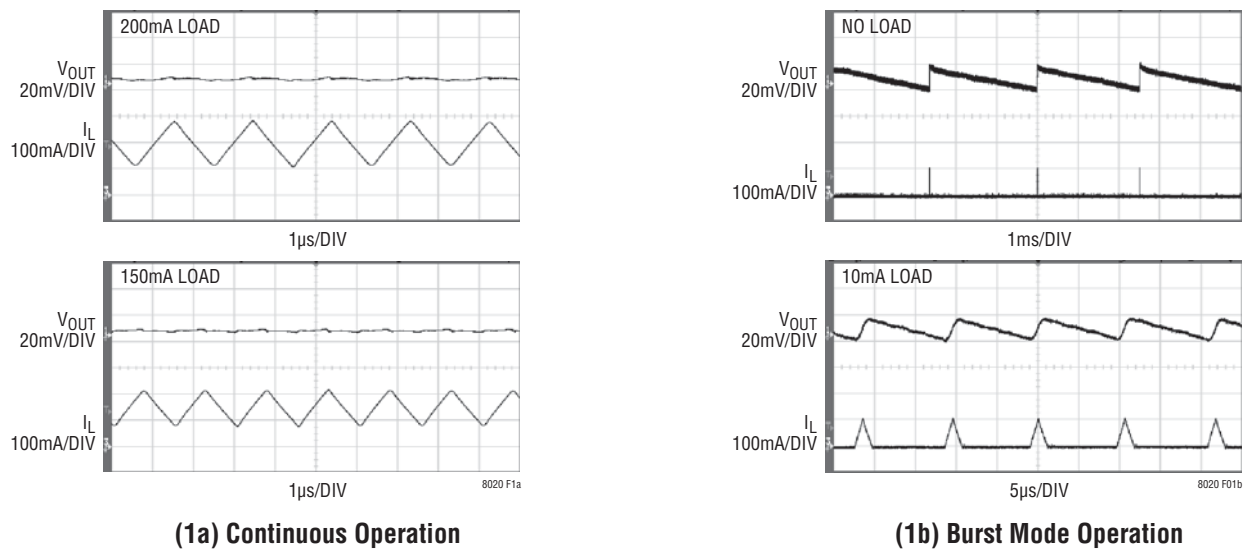

Figure 1. Output Voltage and Internal Inductor Current

## APPLICATIONS INFORMATION

For most applications, the design process is straight forward, summarized as follows:

1. Look at Table 1 and find the row that has the desired input range and output voltage.
2. Apply the  $C_{IN}$ ,  $C_{OUT}$ ,  $R_{ADJ}$  and BIAS connection indicated on that row.

While these component combinations have been tested for proper operation, it is incumbent upon the user to verify proper operation over the intended system's line, load and environmental conditions.

If an output voltage other than those listed in Table 1 is desired, use the equation  $R_{ADJ} = 623.75/(V_{OUT} - 1.25)$ , where  $R_{ADJ}$  is in  $k\Omega$ . As a starting point, use values for  $C_{IN}$  and  $C_{OUT}$  that correspond to the input voltage and output voltage that most closely matches the intended application, and verify proper operation over the system's line, load and environmental conditions.

### Capacitor Selection Considerations

The  $C_{IN}$  and  $C_{OUT}$  capacitor values in Table 1 are the minimum recommended values for the associated operating conditions. Applying capacitor values below those indicated in Table 1 is not recommended, and may result in undesirable operation. An input system bulk capacitor is assumed. Using larger values is generally acceptable, and can yield improved dynamic response, if it is necessary. Again, it is incumbent upon the user to verify proper operation over the intended system's line, load and environmental conditions.

Ceramic capacitors are small, robust and have very low ESR. However, not all ceramic capacitors are suitable. X5R and X7R types are stable over temperature and applied voltage and give dependable service. Other types, including Y5V and Z5U have very large temperature and voltage coefficients of capacitance. In an application circuit they may have only a small fraction of their nominal capacitance resulting in much higher output voltage ripple than expected.

Ceramic capacitors are also piezoelectric. The LTM8020's switching frequency depends on the load current, and at light loads it can excite a ceramic capacitor at audio

frequencies, generating audible noise. Since the LTM8020 operates at a lower current limit during Burst Mode operation, the noise is typically very quiet to a casual ear.

If this audible noise is unacceptable, use a high performance electrolytic capacitor at the output. The input capacitor can be a parallel combination of a  $2.2\mu F$  ceramic capacitor and a low cost electrolytic capacitor.

A final precaution regarding ceramic capacitors concerns the maximum input voltage rating of the LTM8020. A ceramic input capacitor combined with trace or cable inductance forms a high Q (under damped) tank circuit. If the LTM8020 circuit is plugged into a live supply, the input voltage can ring to twice its nominal value, possibly exceeding the device's rating. This situation is easily avoided; see the Hot-Plugging Safely section.

### Shorted Input Protection

Care needs to be taken in systems where the output will be held high when the input to the LTM8020 is absent. This may occur in battery charging applications or in battery backup systems where a battery or some other supply is diode ORed with the LTM8020's output. If the  $V_{IN}$  pin is allowed to float and the SHDN pin is held high (either by a logic signal or because it is tied to  $V_{IN}$ ), then the LTM8020's internal circuitry will pull its quiescent current from its output. This is fine if your system can tolerate a few milliamps in this state. If you ground the  $\overline{\text{SHDN}}$  pin, this quiescent current will drop to essentially zero. However, if the  $V_{IN}$  pin is grounded while the output is held high, then parasitic diodes inside the LTM8020 can pull large currents from the output through the internal power switch, possibly damaging the device. Figure 2 shows a circuit that will run only when the input voltage is present and that protects against a shorted or reversed input.

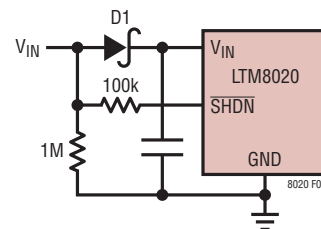

Figure 2. Diode D1 Prevents a Shorted Input from Discharging a Backup Battery Tied to the Output, as Well as Protecting the LTM8020 from a Reversed Input



## APPLICATIONS INFORMATION

### PCB Layout

Most of the headaches associated with PCB layout have been alleviated or even eliminated by the high level of integration of the LTM8020. The LTM8020 is nevertheless a switching power supply, and care must be taken to minimize EMI and ensure proper operation. Even with the high level of integration, you may fail to achieve specified operation with a haphazard or poor layout. See Figure 3 for a suggested layout.

Ensure that the grounding and heat sinking are acceptable. A few rules to keep in mind are:

1. Place the  $C_{IN}$  capacitor as close as possible to the  $V_{IN}$  and GND connection of the LTM8020.
2. Place the  $C_{OUT}$  capacitor as close as possible to the  $V_{OUT}$  and GND connection of the LTM8020.
3. Place the  $C_{IN}$  and  $C_{OUT}$  capacitors such that their ground current flows directly adjacent or underneath the LTM8020.
4. Connect all of the GND connections to as large a copper pour or plane area as possible on the top layer. Avoid breaking the ground connection between the external components and the LTM8020.
5. The copper pours also serve as the heat sink for the LTM8020. Place several vias in the GND plane to act as heat pipes to other layers of the printed circuit board.

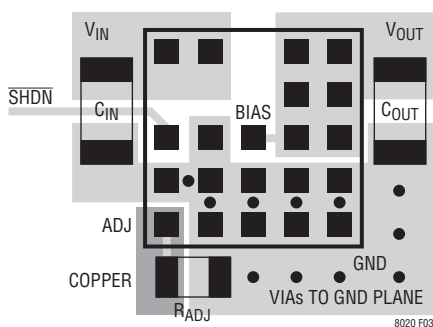

**Figure 3. Layout Showing Suggested External Components, GND Plane and Thermal Vias**

### Positive-to-Negative Voltage Regulation

The LTM8020 can generate a negative output by tying the  $V_{OUT}$  pads to system ground and connecting GND as shown in the Typical Applications section. In this configuration,  $\overline{SHDN}$  must be level shifted or referenced to GND, and the available output current may be reduced.

### Hot-Plugging Safely

The small size, robustness and low impedance of ceramic capacitors make them an attractive option for the input bypass capacitor of LTM8020. However, these capacitors can cause problems if the LTM8020 is plugged into a live supply (see Linear Technology Application Note 88 for a complete discussion). The low loss ceramic capacitor combined with stray inductance in series with the power source forms an under damped tank circuit, and the voltage at the  $V_{IN}$  pin of the LTM8020 can ring to twice the nominal input voltage, possibly exceeding the LTM8020's rating and damaging the part. If the input supply is poorly controlled or the user will be plugging the LTM8020 into an energized supply, the input network should be designed to prevent this overshoot. Figure 4 shows the waveforms that result when an LTM8020 circuit is connected to a 24V supply through six feet of 24-gauge twisted pair. The first plot is the response with a 2.2 $\mu$ F ceramic capacitor at the input. The input voltage rings as high as 35V and the input current peaks at 20A. One method of damping the tank circuit is to add another capacitor with a series resistor to the circuit. In Figure 4b an aluminum electrolytic capacitor has been added. This capacitor's high equivalent series resistance damps the circuit and eliminates the voltage overshoot. The extra capacitor improves low frequency ripple filtering and can slightly improve the efficiency of the circuit, though it is likely to be the largest component in the circuit. An alternative solution is shown in Figure 4c. A 1 $\Omega$  resistor is added in series with the input to eliminate the voltage overshoot (it also reduces the peak input current). A 0.1 $\mu$ F capacitor improves high frequency filtering. This solution is smaller and less expensive than the electrolytic capacitor. For high input voltages its impact on efficiency is minor, reducing efficiency less than one-half percent for a 5V output at full load operating from 24V.

## APPLICATIONS INFORMATION

### High Temperature Considerations

The die temperature of the LTM8020 must be lower than the maximum rating of 125°C, so care should be taken in the layout of the circuit to ensure good heat sinking of the LTM8020. To estimate the junction temperature, approximate the power dissipation within the LTM8020 by applying the typical efficiency stated in this data sheet to the desired output power, or, if you have an actual module, by taking a power measurement. Then calculate the internal temperature rise of the LTM8020 above the surface of the printed circuit board by multiplying the module's power dissipation by the thermal resistance. The actual thermal resistance of the LTM8020 to the printed circuit board depends upon the layout of the circuit board, but the thermal resistance given in the Pin Configuration, which is based upon a 25cm<sup>2</sup> 4-layer FR4 PC board, and the Typical Performance Characteristics can be used as a guide.

Finally, be aware that at high ambient temperatures the internal Schottky diode will have significant leakage current increasing the quiescent current of the LTM8020.

### BIAS Pin Considerations

The BIAS pin is used to provide drive power for the internal power switching stage and operate internal circuitry. For proper operation, it must be powered by at least 3V. If the output voltage is programmed to be 3V or higher, simply tie BIAS to V<sub>OUT</sub>. If V<sub>OUT</sub> is less than 3V, BIAS can be tied to V<sub>IN</sub> or some other voltage source. In all cases, ensure that the maximum voltage at the BIAS pin is both less than 25V and the sum of V<sub>IN</sub> and BIAS is less than 47V. If BIAS power is applied from a remote or noisy voltage source, it may be necessary to apply a decoupling capacitor locally to the LTM8020.

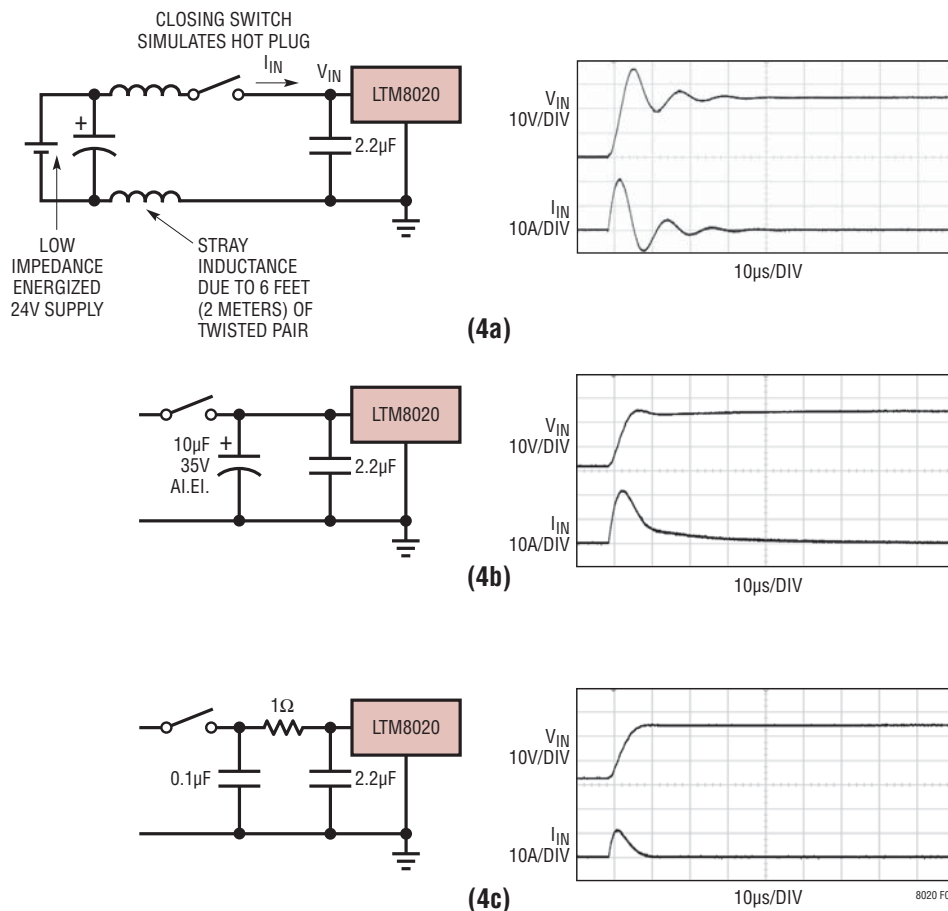

**Figure 4. A Well Chosen Input Network Prevents Input Voltage Overshoot and Ensures Reliable Operation When the LTM8020 is Connected to a Live Supply**

## APPLICATIONS INFORMATION

### Minimum Input Voltage

The LTM8020 is a step-down converter, so a minimum amount of headroom is required to keep the output in regulation. For most applications at full load, the input needs to be at least 1.5V above the desired output. In addition, the input voltage required to turn on depends upon how the  $\overline{\text{SHDN}}$  pin is tied. It takes more input voltage to turn on if  $\overline{\text{SHDN}}$  is tied to  $V_{\text{IN}}$  than if the turn-on is controlled by raising  $\overline{\text{SHDN}}$  when  $V_{\text{IN}}$  is in the required operating range. A graph of the input voltage required to turn the LTM8020 on when  $\overline{\text{SHDN}}$  is tied to  $V_{\text{IN}}$  or when  $\overline{\text{SHDN}}$  is switched is given in the Typical Performance Characteristics section.

### Electromagnetic Compliance

The LTM8020 was evaluated by an independent nationally recognized test lab and found to be compliant with EN55022 class B: 2006 by a wide margin. A sample graph of the LTM8020's radiated EMC performance is given in the Typical Performance Characteristics section, while further data, operating conditions and test setup are detailed in the electromagnetic compatibility test report, available on the Linear Technology website. Conducted emissions requirements may be met by adding an appropriate input power line filter. The proper implementation of this filter depends upon the system operating and performance conditions as a whole, of which the LTM8020 is typically only a component, so conducted emissions are not addressed at this level.

**Table 1. Recommended External Component Values and Configuration**

$V_{\text{IN}}$ RANGE	$V_{\text{OUT}}$	$C_{\text{IN}}$	$C_{\text{OUT}}$	$R_{\text{ADJ}}$	BIAS CONNECTION
4.5V - 36V	1.25V	2.2 $\mu$ F 50V 1206 X7R	47 $\mu$ F 6.3V 1206 X5R	Open	>2V, < 25V
4.5V - 36V	1.5V	2.2 $\mu$ F 50V 1206 X7R	47 $\mu$ F 6.3V 1206 X5R	2.43M	>2V, < 25V
4.5V - 36V	1.8V	2.2 $\mu$ F 50V 1206 X7R	47 $\mu$ F 6.3V 1206 X5R	1.1M	>2V, < 25V
4.5V - 36V	2.5V	2.2 $\mu$ F 50V 1206 X7R	22 $\mu$ F 6.3V 1206 X7R	499k	$V_{\text{OUT}}$
4.5V - 36V	3.3V	2.2 $\mu$ F 50V 1206 X7R	10 $\mu$ F 6.3V 1206 X7R	301k	$V_{\text{OUT}}$
6.5V - 36V	5V	2.2 $\mu$ F 50V 1206 X7R	10 $\mu$ F 6.3V 1206 X7R	165k	$V_{\text{OUT}}$
4.5V - 15V	1.25V	2.2 $\mu$ F 16V 0805 X7R	22 $\mu$ F 6.3V 1206 X7R	Open	$V_{\text{IN}}$
4.5V - 15V	1.5V	2.2 $\mu$ F 16V 0805 X7R	10 $\mu$ F 6.3V 0805 X7R	2.43M	$V_{\text{IN}}$
4.5V - 15V	1.8V	2.2 $\mu$ F 16V 0805 X7R	10 $\mu$ F 6.3V 0805 X7R	1.1M	$V_{\text{IN}}$
4.5V - 15V	2.5V	2.2 $\mu$ F 16V 0805 X7R	10 $\mu$ F 6.3V 0805 X7R	499k	$V_{\text{IN}}$
4.5V - 15V	3.3V	2.2 $\mu$ F 16V 0805 X7R	10 $\mu$ F 6.3V 0805 X7R	301k	$V_{\text{OUT}}$
6.5V - 15V	5V	2.2 $\mu$ F 16V 0805 X7R	None	165k	$V_{\text{OUT}}$
9V - 24V	1.25V	1 $\mu$ F 25V 0805 X7R	47 $\mu$ F 6.3V 0805 X5R	Open	$V_{\text{IN}}$
9V - 24V	1.5V	1 $\mu$ F 25V 0805 X7R	47 $\mu$ F 6.3V 0805 X7R	2.43M	$V_{\text{IN}}$
9V - 24V	1.8V	1 $\mu$ F 25V 0805 X7R	10 $\mu$ F 6.3V 0805 X7R	1.1M	$V_{\text{IN}}$
9V - 24V	2.5V	1 $\mu$ F 25V 0805 X7R	10 $\mu$ F 6.3V 0805 X7R	499k	$V_{\text{IN}}$
9V - 24V	3.3V	1 $\mu$ F 25V 0805 X7R	10 $\mu$ F 6.3V 0805 X7R	301k	$V_{\text{OUT}}$
9V - 24V	5V	4.7 $\mu$ F 25V 0805 X7R	10 $\mu$ F 6.3V 0805 X5R	165k	$V_{\text{OUT}}$
18V - 36V	1.25V	2.2 $\mu$ F 50V 1206 X7R	47 $\mu$ F 6.3V 1206 X5R	Open	>2V, <25V
18V - 36V	1.5V	2.2 $\mu$ F 50V 1206 X7R	47 $\mu$ F 6.3V 1206 X5R	2.43M	>2V, <25V
18V - 36V	1.8V	2.2 $\mu$ F 50V 1206 X7R	22 $\mu$ F 6.3V 1206 X7R	1.1M	>2V, <25V
18V - 36V	2.5V	2.2 $\mu$ F 50V 1206 X7R	10 $\mu$ F 6.3V 0805 X7R	499k	$V_{\text{OUT}}$
18V - 36V	3.3V	2.2 $\mu$ F 50V 1206 X7R	10 $\mu$ F 6.3V 0805 X7R	301k	$V_{\text{OUT}}$
18V - 36V	5V	2.2 $\mu$ F 50V 1206 X7R	10 $\mu$ F 6.3V 0805 X7R	165k	$V_{\text{OUT}}$
3.3V - 30V	-3.3V	2.2 $\mu$ F 50V 1206 X7R	22 $\mu$ F 6.3V 0805 X7R	301k	$V_{\text{OUT}}$
5V - 30V	-5V	2.2 $\mu$ F 50V 1206 X7R	10 $\mu$ F 6.3V 0805 X7R	165k	$V_{\text{OUT}}$

8020fd

## TYPICAL APPLICATIONS

### 1.25V Step-Down Converter

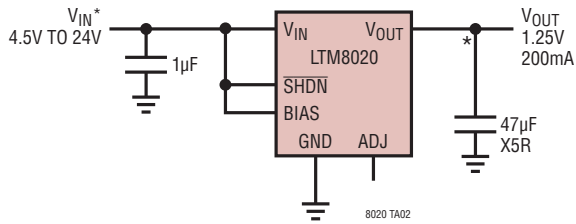

### 3.3V Step-Down Converter

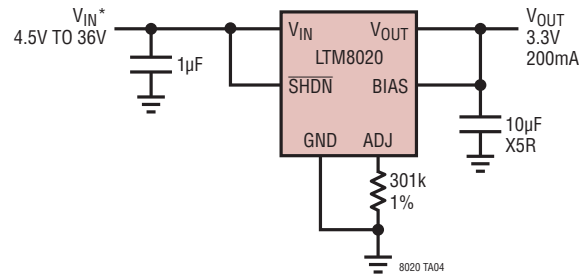

### 1.8V Step-Down Converter

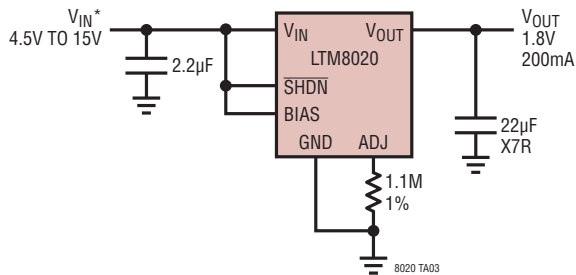

### 5V Step-Down Converter (No Output Capacitor Required)

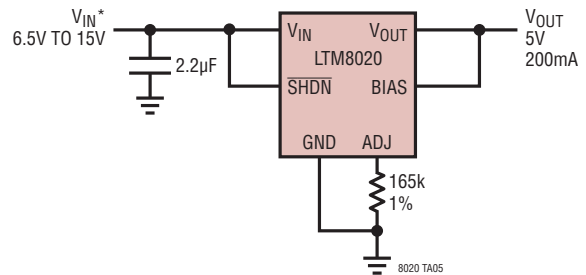

### -5V Positive-to-Negative Converter

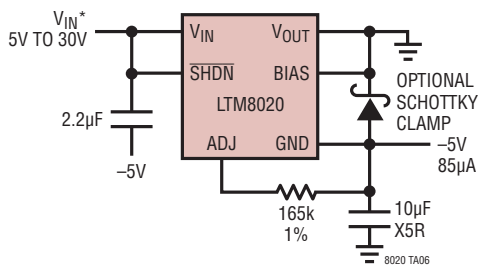

### -5V Positive-to-Negative Converter Output vs Input Voltage

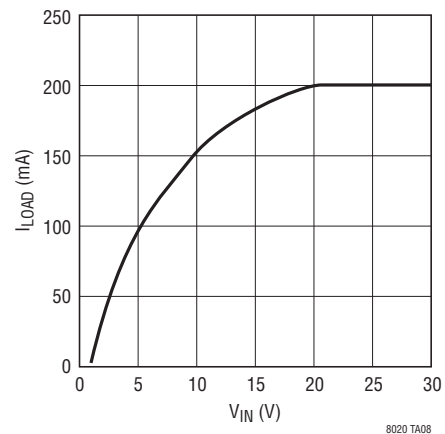

\* RUNNING VOLTAGE RANGE. PLEASE REFER TO APPLICATIONS INFORMATION FOR START-UP DETAILS

# PACKAGE DESCRIPTION

**LGA Package**  
**21-Lead (6.25mm × 6.25mm × 2.32mm)**  
 (Reference LTC DWG # 05-08-1803 Rev A)

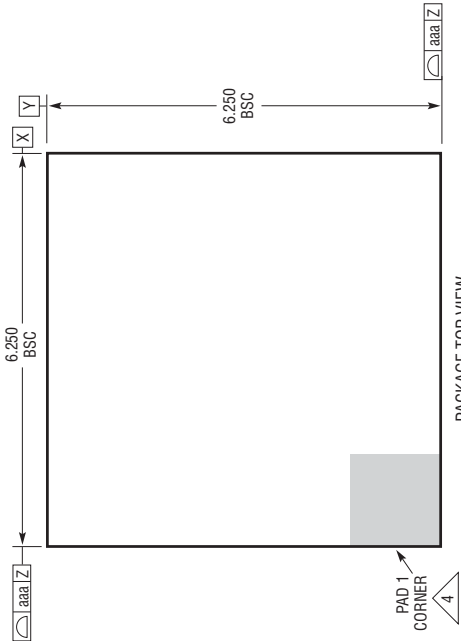
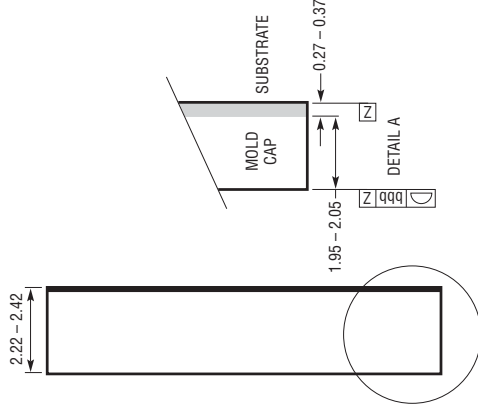
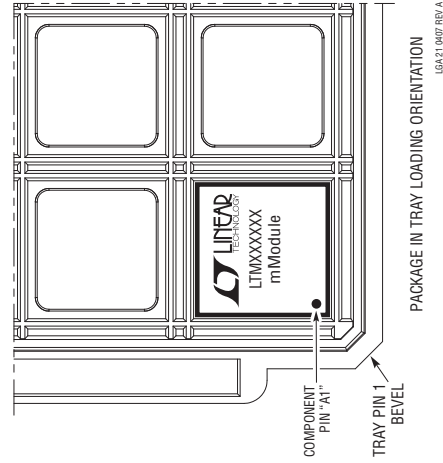
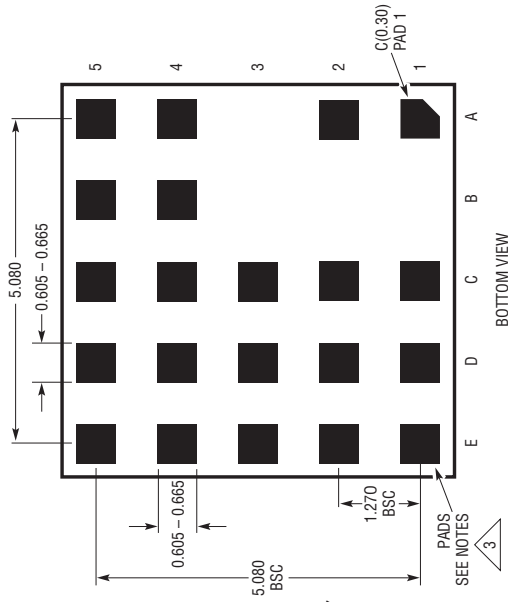

DETAIL A  
PACKAGE SIDE VIEW

PACKAGE TOP VIEW

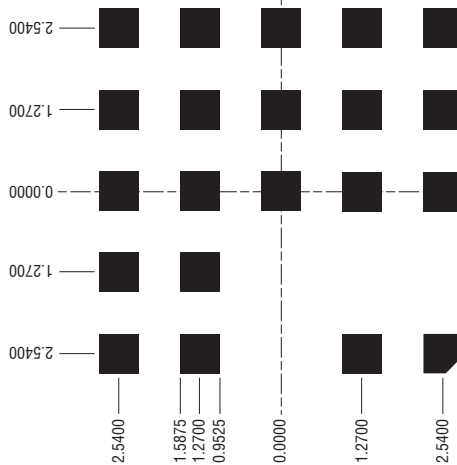

SUGGESTED PCB LAYOUT  
TOP VIEW

- NOTES:
1. DIMENSIONING AND TOLERANCING PER ASME Y14.5M-1994
  2. ALL DIMENSIONS ARE IN MILLIMETERS
  3. LAND DESIGNATION PER JEDEC MO-222, SPP-010 AND SPP-020
  4. DETAILS OF PAD #1 IDENTIFIER ARE OPTIONAL, BUT MUST BE LOCATED WITHIN THE ZONE INDICATED. THE PAD #1 IDENTIFIER MAY BE EITHER A MOLD OR A MARKED FEATURE
  5. PRIMARY DATUM - Z - IS SEATING PLANE
  6. THE TOTAL NUMBER OF PADS: 21

SYMBOL	TOLERANCE
aaa	0.15
bbb	0.10

**PACKAGE DESCRIPTION****LTM8020 Pinout (Sorted by Pin Number)**

<b>PIN</b>	<b>SIGNAL DESCRIPTION</b>
A1	$V_{IN}$
A2	$V_{IN}$
A4	$V_{OUT}$
A5	$V_{OUT}$
B4	$V_{OUT}$
B5	$V_{OUT}$
C1	$\overline{SHDN}$
C2	GND
C3	BIAS
C4	$V_{OUT}$
C5	$V_{OUT}$
D1	GND
D2	GND
D3	GND
D4	GND
D5	GND
E1	ADJ
E2	GND
E3	GND
E4	GND
E5	GND

**REVISION HISTORY** (Revision history begins at Rev D)

REV	DATE	DESCRIPTION	PAGE NUMBER
D	3/10	Changes to Description and Features	1
		Changes to Applications Information	8
		“Electromagnetic Compliance” Paragraph Added to Applications Information	11
		Changes to Typical Application	13

## TYPICAL APPLICATION

3.3V Step-Down Converter

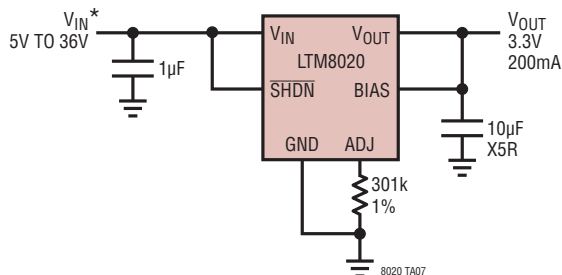

\*RUNNING VOLTAGE RANGE. PLEASE REFER TO APPLICATIONS INFORMATION FOR START-UP DETAILS

## RELATED PARTS

PART NUMBER	DESCRIPTION	COMMENTS
LTM4600	10A DC/DC $\mu$ Module	Basic 10A DC/DC $\mu$ Module, 15mm $\times$ 15mm $\times$ 2.8mm LGA
LTM4600HVMPV	Military Plastic 10A DC/DC $\mu$ Module	-55°C to 125°C Operation, 15mm $\times$ 15mm $\times$ 2.8mm LGA
LTM4601/ LTM4601A	12A DC/DC $\mu$ Module with PLL, Output Tracking/Margining and Remote Sensing	Synchronizable, PolyPhase Operation, LTM4601-1 Version has no Remote Sensing
LTM4602	6A DC/DC $\mu$ Module	Pin Compatible with the LTM4600
LTM4603	6A DC/DC $\mu$ Module with PLL and Output Tracking/Margining and Remote Sensing	Synchronizable, PolyPhase Operation, LTM4603-1 Version has no Remote Sensing, Pin Compatible with the LTM4601
LTM4604	4A Low $V_{IN}$ DC/DC $\mu$ Module	$2.375V \leq V_{IN} \leq 5V$ , $0.8V \leq V_{OUT} \leq 5V$ , 9mm $\times$ 15mm $\times$ 2.3mm LGA
LTM4608	8A Low $V_{IN}$ DC/DC $\mu$ Module	$2.375V \leq V_{IN} \leq 5V$ , $0.8V \leq V_{OUT} \leq 5V$ , 9mm $\times$ 15mm $\times$ 2.8mm LGA
LTM8022	1A, 36V DC/DC $\mu$ Module	Adjustable Frequency, $0.8V \leq V_{OUT} \leq 5V$ , 11.25mm $\times$ 9mm $\times$ 2.82mm, Pin Compatible to the LTM8023
LTM8023	2A, 36V DC/DC $\mu$ Module	Adjustable Frequency, $0.8V \leq V_{OUT} \leq 5V$ , 11.25mm $\times$ 9mm $\times$ 2.82mm, Pin Compatible to the LTM8022