



1.0A GENERAL PURPOSE RECTIFIERS - 50V- 1000V SMA-L PACKAGE

Features

- Batch process design, excellent power dissipation offers better reverse leakage current and thermal resistance.
- Low profile surface mounted application in order to optimize board space.
- High current capability.
- High surge capability.
- Glass passivated chip junction.
- **Moisture Sensitivity Level 1**

Package outline

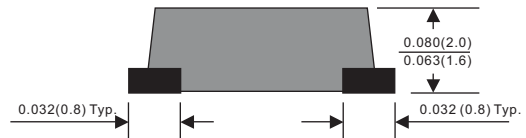
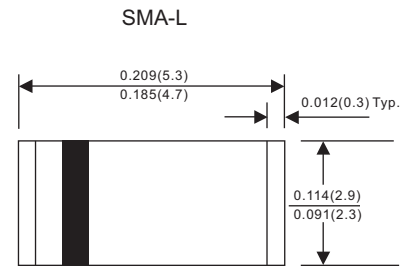

Dimensions in inches and (millimeters)

Mechanical data

- Epoxy:UL94-V0 rated flame retardant
- Case : Molded plastic, SMA-L
- Terminals : Solder plated, solderable per MIL-STD-750, Method 2026
- Polarity : Indicated by cathode band
- Mounting Position : Any
- Weight : Approximated 0.05 gram

Maximum ratings and Electrical Characteristics (AT $T_A=25^\circ\text{C}$ unless otherwise noted)

PARAMETER	CONDITIONS	Symbol	MIN.	TYP.	MAX.	UNIT
Forward rectified current	See Fig.2	I_o			1.0	A
Forward surge current	8.3ms single half sine-wave superimposed on rate load (JEDEC methode)	I_{FSM}			30	A
Reverse current	$V_R = V_{RRM} \quad T_J = 25^\circ\text{C}$	I_R			5.0	μA
	$V_R = V_{RRM} \quad T_J = 125^\circ\text{C}$				50	
Diode junction capacitance	$f=1\text{MHz}$ and applied 4V DC reverse voltage	C_J		15		pF
Storage temperature		T_{STG}	-55		+150	$^\circ\text{C}$

SYMBOLS	V_{RRM}^{*1} (V)	V_{RMS}^{*2} (V)	V_R^{*3} (V)	V_F^{*4} (V)	Operating temperature $T_J, (^\circ\text{C})$
FM4001L	50	35	50	1.10	-55 to +150
FM4002L	100	70	100		
FM4003L	200	140	200		
FM4004L	400	280	400		
FM4005L	600	420	600		
FM4006L	800	560	800		
FM4007L	1000	700	1000		

*1 Repetitive peak reverse voltage

*2 RMS voltage

*3 Continuous reverse voltage

*4 Maximum forward voltage@ $I_F=1.0\text{A}$



Rating and characteristic curves

FIG.1-TYPICAL FORWARD CHARACTERISTICS

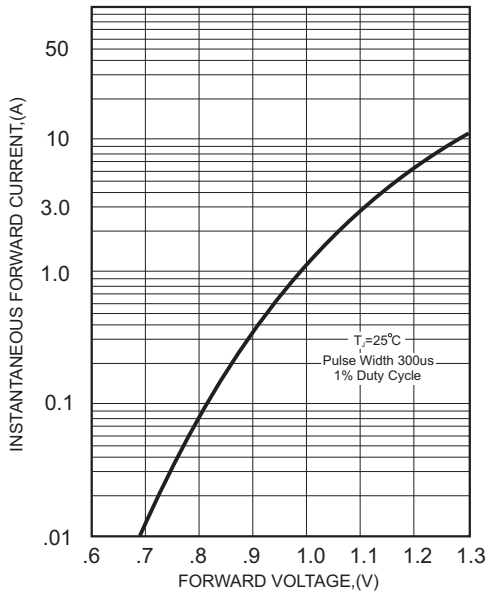

FIG.2-TYPICAL FORWARD CURRENT DERATING CURVE

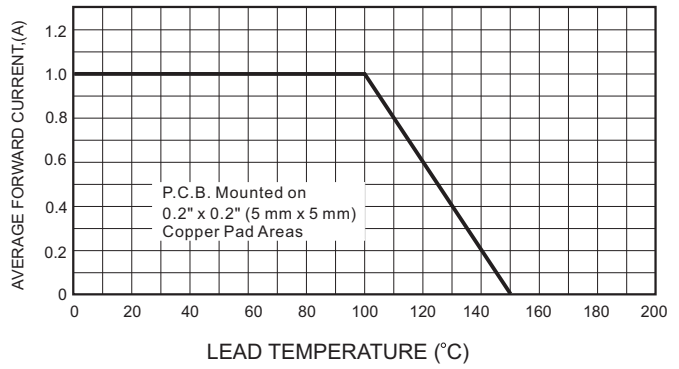

FIG.4-MAXIMUM NON-REPETITIVE FORWARD SURGE CURRENT

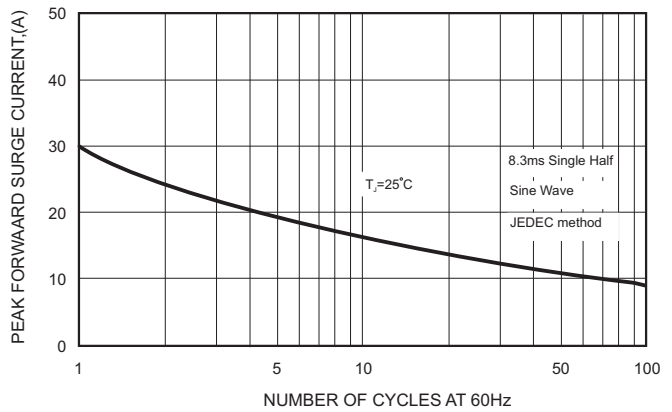

FIG.3 - TYPICAL REVERSE CHARACTERISTICS

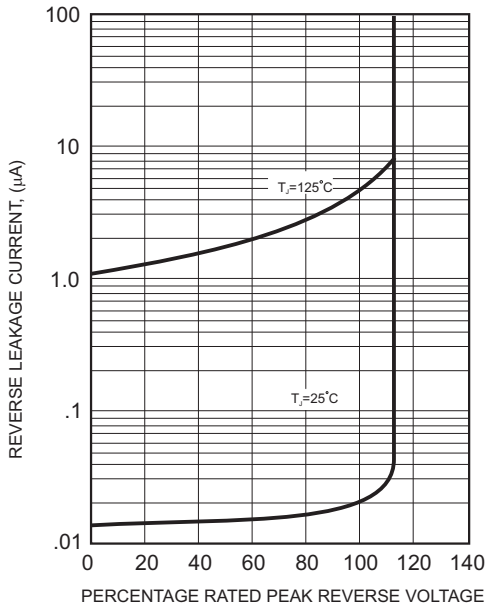
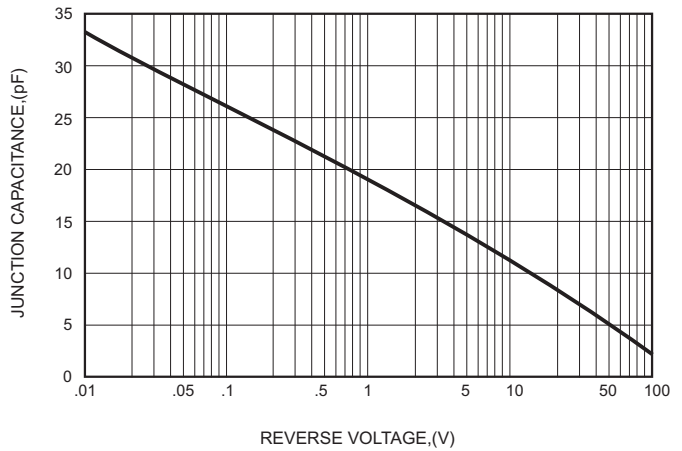

FIG.5-TYPICAL JUNCTION CAPACITANCE





1.0A GENERAL PURPOSE RECTIFIERS - 50V- 1000V SMA-L PACKAGE

Pinning information

Pin	Simplified outline	Symbol
Pin1 cathode Pin2 anode		

Reel packing

PACKAGE	REEL SIZE	REEL (pcs)	COMPONENT SPACING (m/m)	BOX (pcs)	INNER BOX (m/m)	REEL DIA. (m/m)	CARTON SIZE (m/m)	CARTON (pcs)	APPROX. GROSS WEIGHT (kg)
SMA-L	7"	2,000	4.0	20,000	183*170*183	178	382*356*387	160,000	15.5
SMA-L	13"	7,500	4.0	15,000	337*337*37	330	350*330*360	120,000	14.2

Marking

Type number	Marking code
FM4001L	A1
FM4002L	A2
FM4003L	A3
FM4004L	A4
FM4005L	A5
FM4006L	A6
FM4007L	A7

Pb-Free package is available

RoHS product for packing code suffix "G"

Halogen free product for packing code suffix "H"

Suggested solder pad layout

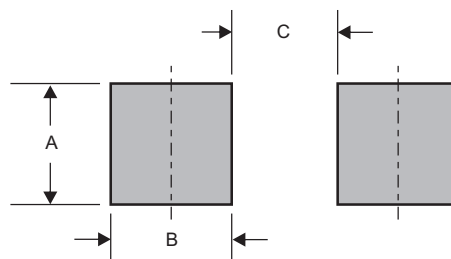

Dimensions in inches and (millimeters)

PACKAGE	A	B	C
SMA-L	0.110 (2.80)	0.059 (1.50)	0.110 (2.80)



1.0A GENERAL PURPOSE RECTIFIERS - 50V- 1000V SMA-L PACKAGE

Packing information

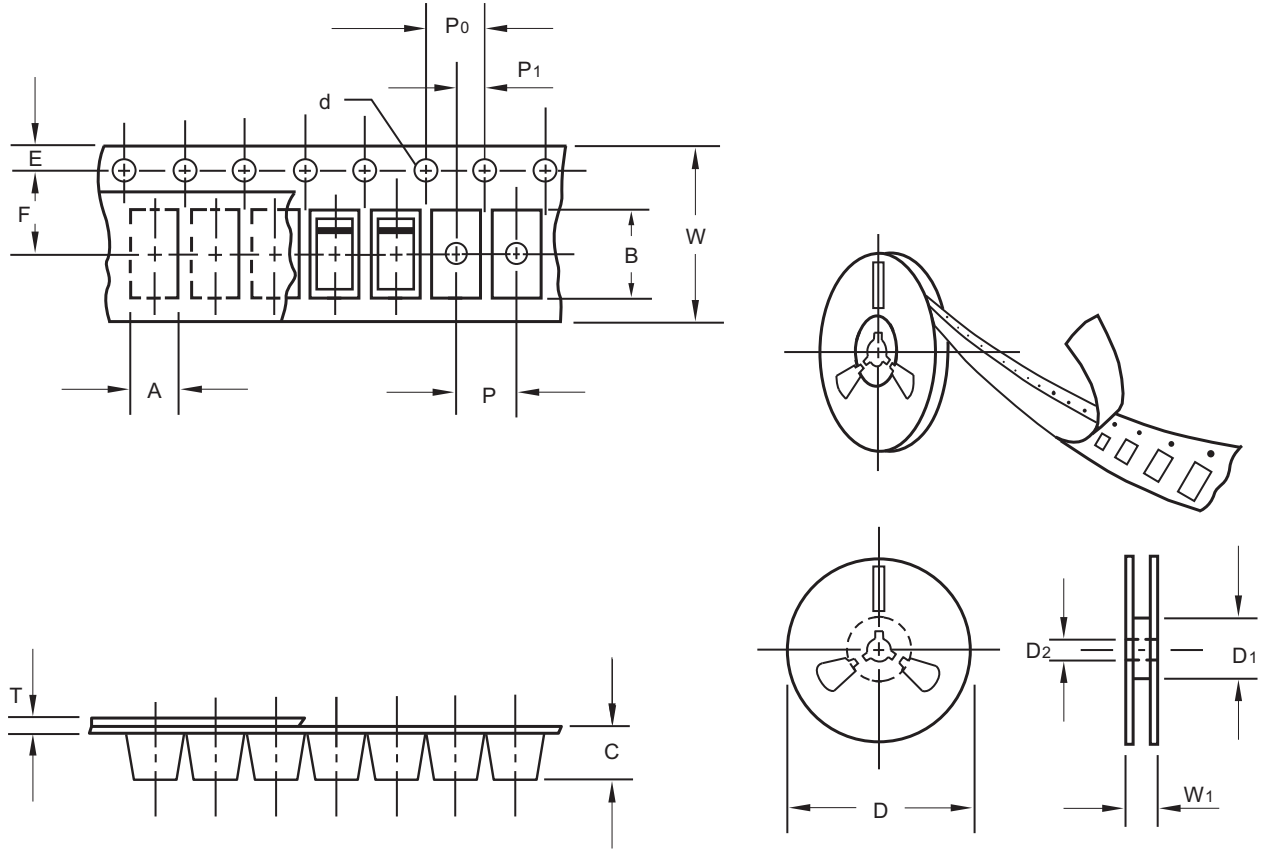

unit:mm

Item	Symbol	Tolerance	SMA-L
Carrier width	A	0.1	2.90
Carrier length	B	0.1	5.50
Carrier depth	C	0.1	2.10
Sprocket hole	d	0.1	1.50
13" Reel outside diameter	D	2.0	330.00
13" Reel inner diameter	D1	min	50.00
7" Reel outside diameter	D	2.0	178.00
7" Reel inner diameter	D1	min	62.00
Feed hole diameter	D2	0.5	13.00
Sprocket hole position	E	0.1	1.75
Punch hole position	F	0.1	5.50
Punch hole pitch	P	0.1	4.00
Sprocket hole pitch	P0	0.1	4.00
Embossment center	P1	0.1	2.00
Overall tape thickness	T	0.1	0.23
Tape width	W	0.3	12.00
Reel width	W1	1.0	18.00

Note: Devices are packed in accordance with EIA standard RS-481-A and specifications listed above.