

Optoisolators

Phototransistors		Total Device Ratings			LED Max Ratings		Phototransistor Ratings				Ckt. Diag.	Fig. No.
ECG Type	Output Configuration	Isolation Voltage Viso Surge (V)	Total Power P _t (mW)	DC Current Transfer Ratio % *	Forward Current I _F (mA)	Reverse Voltage V _R (V)	Collector to Base Voltage BV _{CB0} (V)	Collector to Emitter Voltage BV _{CEO} (V)	Collector Current I _c (mA)	Typ Freq KHz		
ECG3040	NPN Transistor	7500	250	20	80	3	70	30	3.5 Typ	300	A	P28
ECG3041	NPN Transistor	7500	250	100	60	6	70	30	100 Max	150	A	
ECG3042	NPN Transistor	7500	250	20	60	3	70	30	50 Max	150	A	
ECG3043	NPN Transistor	3550	260	70	60	3	70	80	50 Max	100	A	
ECG3044	NPN Darlington	7500	300	300	80	3	--	80	150 Max	75	B	
ECG3045	NPN Darlington	7500	300	500	80	3	--	80	150 Max	75	B	
ECG3081	NPN Transistor	6000	250	20	60	3	--	30	100	100	D	P27
ECG3082	NPN Darlington	6000	250	400	60	3	--	30	100	75	C	
ECG3083	NPN Darlington	7500	250	100	60	3	55	55	100	75	E	P28
ECG3084	NPN Darlington	7500	250	200	60	3	30	30	100	75	E	
ECG3086	NPN Dual Transistor	7500	400	50	60	3	---	30	30	200	F	P29
ECG3220	NPN Dual Transistor	5000	150	100	50	5	---	55	50	---	V	
ECG3088	NPN Transistor	7500	300	20	60	6	300	300 (BV _{CER})	100	200	A	P28
ECG3089	NPN Transistor	7500	300	20	60	--	70	30	100	200	M	
ECG3096	Low Input Drive NPN Transistor	7500	300	50 @ IF 1 mA	60	6.0	70	30	100	200	A	
ECG3098	NPN Transistor	5000	250	100	60	5	---	55	50	---	S	P55
ECG3221	NPN Quad Transistor	5000	150	100	50	5	---	55	50	---	W	P61

* DC Current Transfer Ratio is the output transistor collector current divided by the LED forward current - $hFE = I_c / I_F$

Photothyristors		Total Device Ratings		LED Max Ratings		Photothyristor Ratings					Ckt. Diag.	Fig. No.
ECG Type	Output Configuration	Isolation Voltage Viso Surge (V)	Power P _t (mW)	Forward Current I _F (mA)	Reverse Voltage V _R (V)	V _{DRM} (V)	I _T RMS (mA)	I _{FT} (mA)	V _F (on) 100 mA (V)	I _{HOLD} (mA)		
ECG3046	SCR	3550	260	60	3	400	100	14	1.3	.5	G	P28
ECG3047	TRIAC	7500	330	50	3	250	100	10	3.0	.1	H	
ECG3048	TRIAC	7500	330	50	3	400	100	10	3.0	.1	H	
ECG3049	TRIAC with Zero Crossing Circuit	7500	330	50	3	250	100	15	3.0	.1	J	
ECG3091	SCR	4000	400	60	6	400	300	11	1.3 at 300 mA	.5	G	
ECG3097	TRIAC with Zero Crossing Circuit	7500	300	50	6	400	100	15	3.0	.2	J	

Photo FET		Total Device Ratings		LED Max Ratings		Photo FET Ratings					Ckt. Diag.	Fig. No.
ECG Type	Output Configuration	Isolation Voltage Viso Surge (V)	Power P _t (mW)	Forward Current I _F (mA)	Reverse Voltage V _R (V)	Drain to Source Breakdown Voltage BV _{DSS} (V)	Drain Current I _D (mA)	R _{DSon} (Ohms)	T _{on} (μsec)	T _{off} (μsec)		
ECG3085	FET	2500	300	60	6	±30	±100	200	15	15	K	P28

TTL Compatible Photo Coupled Logic Gates		Total Device Ratings		LED Ratings		Output Ratings				Ckt. Diag.	Fig. No.
ECG Type	Output Configuration	Isolation Voltage Viso (V)	Power P _t (mW)	Forward Current I _F (mA)	Reverse Voltage V _R (V)	Max Supply Voltage V _{CC} (V)	Output Current I _O (mA)	Propagation Delay Time (nsecs)	Enable Voltage V _E (V)		
ECG3087	Hi Speed Open Collector, NAND Gate	3000	100	10	5.0	5.0	50	75	5.0	L	P29
ECG3094	Dual Hi Speed Open Collector, NAND Gates	3000	60	15	5.0	5.0	16 Per Channel	75	--	Q	

Optoisolators (cont'd)

TTL Compatible Phototransistors		Device Ratings		LED Max Ratings		Output Ratings					Ckt. Diag.	Fig. No.
ECG Type	Output Configuration	Isolation Voltage Viso (V)	Power Pt (mW)	Forward Current I _F (mA)	Reverse Voltage V _R (V)	Max V _{CC} (V)	Current Transfer Ratio % *	Output Current I _O (mA)	Propagation Delay Time (nsec)	Data Transfer Rate Mbit/sec		
ECG3092	Open Collector NPN Transistor	3000	100	25	5	15	15	8	800	1	O	P29
ECG3093	NPN Split Darlington	3000	100	20	5	18	400	60	t _{PHL} 1 μsec t _{PLH} 7 μsec	100K	P	
ECG3095	Dual Open Collector, NPN Transistors	3000	100	25	5	15	15	8	800	1	R	

* DC Current Transfer Ratio is the output transistor collector current divided by the LED forward current - $h_{FE} = I_C / I_F$

ECG Type	Output Configuration	Total Device Ratings		Led Max Ratings		Output Ratings					Ckt. Diag.	Fig. No.
		Isolation Voltage Viso Surge (V)	Power Pt (mW)	Forward Current I _F (mA)	Reverse Voltage V _R (V)	V _{CC} Voltage Range (V)	Output Voltage V _O (V)	Output Current I _O (mA)	Turn-On Time T _{on} (μsec)	Turn-Off Time T _{off} (μsec)		
ECG3090	Schmitt Trigger	7500	150	60	6	3V to 15V	15 max	50 max	1.2 typ	1.2 typ	N	P28

Optoisolator Circuits

<p>Diag. A ECG 3040 3041 3042 3043 3088 3096</p> <p>Fig. P28</p>	<p>Diag. B ECG 3044 3045</p> <p>Fig. P28</p>	<p>Diag. C ECG3082</p> <p>Fig. P27</p>
<p>Diag. D ECG3081</p> <p>Fig. P27</p>	<p>Diag. E ECG 3083 3084</p> <p>Fig. P28</p>	<p>Diag. F ECG3086</p> <p>Fig. P29</p>
<p>Diag. G ECG 3046 3091</p> <p>Fig. P28</p>	<p>Diag. H ECG 3047 3048</p> <p>Fig. P28</p>	<p>Diag. J ECG 3049 3097</p> <p>Fig. P28</p>
<p>Diag. K ECG3085</p> <p>Fig. P28</p>	<p>Diag. L ECG3087</p> <p>Fig. P29</p>	<p>Diag. M ECG3089</p> <p>Fig. P28</p>

Optoisolator Circuits (cont'd)

Diag. N
ECG3090 Fig. P28

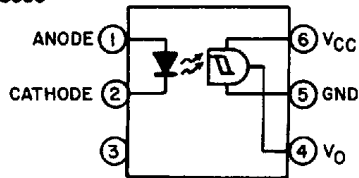

Diag. O
ECG3092 Fig. P29

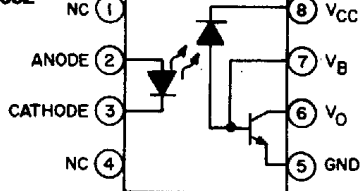

Diag. P
ECG3093 Fig. P29

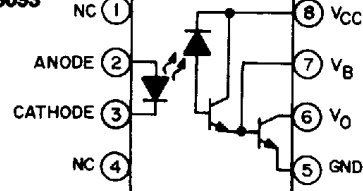

Diag. Q
ECG3094 Fig. P29

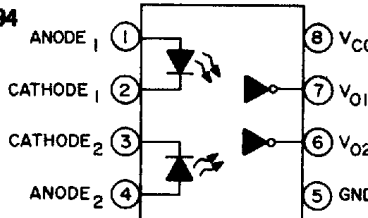

Diag. R
ECG3095 Fig. P29

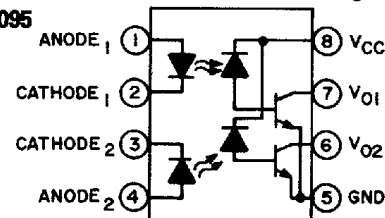

Diag. S
ECG3098 Fig. P55

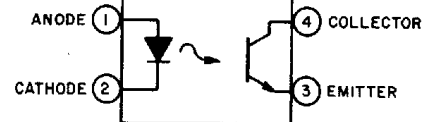

Diag. V
ECG3220 Fig. P29

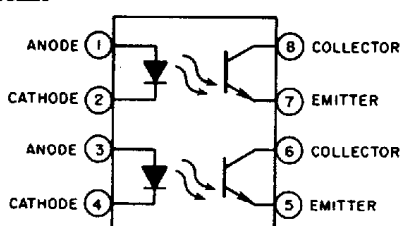

Diag. W
ECG3221 Fig. P61

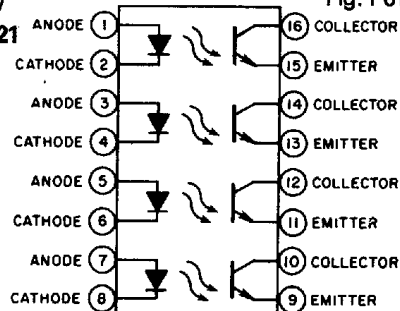

Optoisolator Outlines

Fig. P27

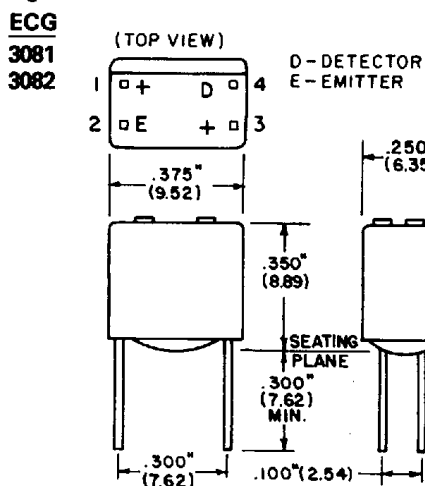

Fig. P28

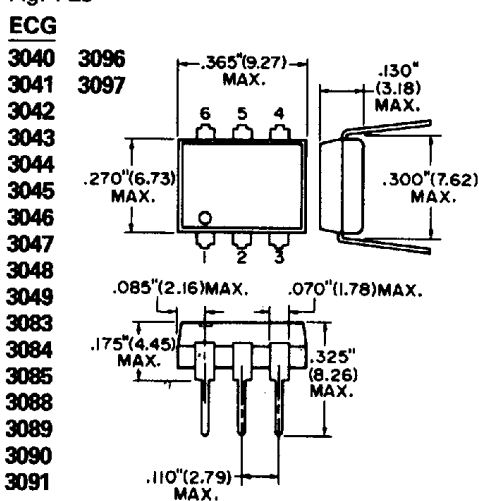

Fig. P29

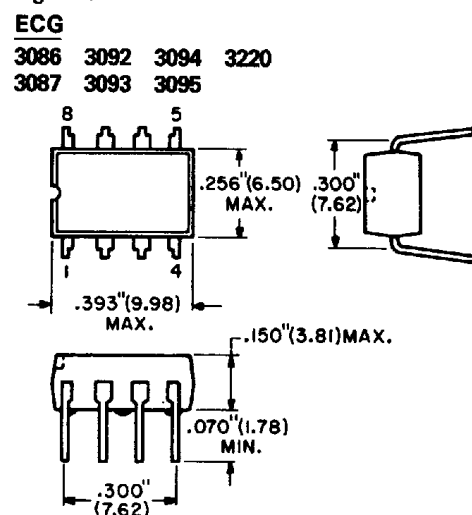

Fig. P55

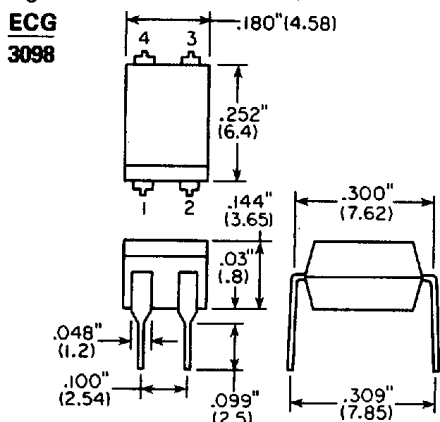

Fig. P61

