



U74AHC1G08

CMOS IC

2-INPUT AND GATE

DESCRIPTION

The UTC **U74AHC1G08** is a high-speed si-gate CMOS device which provides the 2-input AND function.

FEATURES

- * Operation Voltage Range: 2~5.5V
- * Low Power Current: $I_{CC}=10\mu A(\text{Max})$
- * High speed: $t_{PD}=4.3\text{ns}(\text{Typ}) @ V_{CC}=5V$

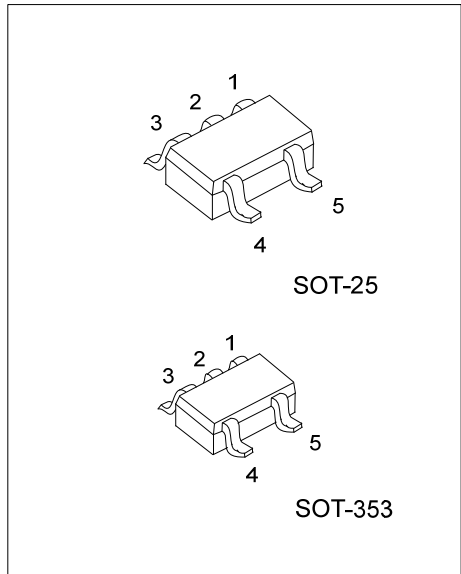

ORDERING INFORMATION

Ordering Number		Package	Packing
Lead Free	Halogen Free		
U74AHC1G08L-AF5-R	U74AHC1G08G-AF5-R	SOT-25	Tape Reel
U74AHC1G08L-AL5-R	U74AHC1G08G-AL5-R	SOT-353	Tape Reel

<p>U74AHC1G08L-AF5-R</p> <p>(1) Packing Type (2) Package Type (3) Lead Free</p>	<p>(1) R: Tape Reel (2) AF5: SOT-25, AL5: SOT-353 (3) G: Halogen Free, L: Lead Free</p>
---	---

MARKING

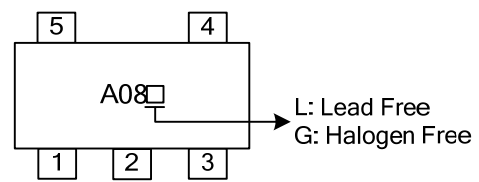

■ PIN CONFIGURATION

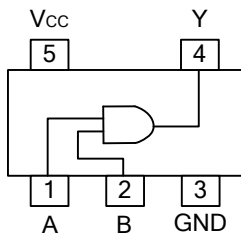

■ FUNCTION TABLE (each gate)

INPUTS		OUTPUT
A	B	Y
L	L	L
L	H	L
H	L	L
H	H	H

■ LOGIC DIAGRAM (positive logic)

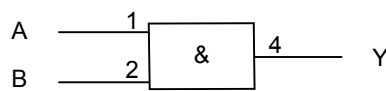
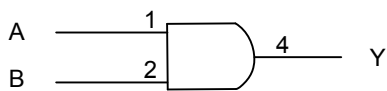

IEC logic symbol

■ ABSOLUTE MAXIMUM RATINGS

PARAMETER	SYMBOL	RATINGS	UNIT
Supply Voltage	V_{CC}	-0.5~7	V
Input Voltage	V_{IN}	-0.5~7	V
Output Voltage	V_{OUT}	-0.5~ $V_{CC}+0.5$	V
Input Clamp Current	I_{IK}	-20	mA
Output Clamp Current	I_{OK}	± 20	mA
Output Current	I_{OUT}	± 25	mA
V_{CC} or GND Current	I_{CC}	± 50	mA
Storage Temperature	T_{STG}	-65 ~ +150	$^{\circ}C$

Note: Absolute maximum ratings are those values beyond which the device could be permanently damaged. Absolute maximum ratings are stress ratings only and functional device operation is not implied.

■ RECOMMENDED OPERATING CONDITIONS

PARAMETER	SYMBOL	CONDITIONS	MIN	TYP	MAX	UNIT
Supply Voltage	V_{CC}		2		5.5	V
Input Voltage	V_{IN}		0		5.5	V
Output Voltage	V_{OUT}		0		V_{CC}	V
Input Transition Rise or Fall Times	t_R, t_F	$V_{CC}=3.3V \pm 0.3V$			100	ns/V
		$V_{CC}=5.0V \pm 0.5V$			20	
Operating Temperature	T_{OPR}		-40		125	$^{\circ}C$

■ STATIC CHARACTERISTICS ($T_A=25^{\circ}C$)

PARAMETER	SYMBOL	TEST CONDITIONS	MIN	TYP	MAX	UNIT
High-Level Input Voltage	V_{IH}	$V_{CC}=2.0V$	1.5			V
		$V_{CC}=3.0V$	2.1			V
		$V_{CC}=5.5V$	3.85			V
Low-Level Input Voltage	V_{IL}	$V_{CC}=2.0V$			0.5	V
		$V_{CC}=3.0V$			0.9	V
		$V_{CC}=5.5V$			1.65	V
High-Level Output Voltage	V_{OH}	$V_{CC}=2.0V, I_{OH}=-50\mu A$	1.9	2.0		V
		$V_{CC}=3.0V, I_{OH}=-50\mu A$	2.9	3.0		V
		$V_{CC}=4.5V, I_{OH}=-50\mu A$	4.4	4.5		V
		$V_{CC}=3.0V, I_{OH}=-4mA$	2.58			V
		$V_{CC}=4.5V, I_{OH}=-8mA$	3.94			V
Low-Level Output Voltage	V_{OL}	$V_{CC}=2.0V, I_{OL}=50\mu A$			0.1	V
		$V_{CC}=3.0V, I_{OL}=50\mu A$			0.1	V
		$V_{CC}=4.5V, I_{OL}=50\mu A$			0.1	V
		$V_{CC}=3.0V, I_{OL}=4mA$			0.36	V
		$V_{CC}=4.5V, I_{OL}=8mA$			0.36	V
Input Leakage Current	$I_{I(LEAK)}$	$V_{CC}=0\sim 5.5V, V_{IN}=V_{CC}$ or GND			± 0.1	μA
Quiescent Supply Current	I_Q	$V_{CC}=5.5V, V_{IN}=V_{CC}$ or GND, $I_{OUT}=0$			1	μA
Input Capacitance	C_{IN}	$V_{CC}=5V, V_{IN}=V_{CC}$ or GND		4	10	pF

■ DYNAMIC CHARACTERISTICS ($T_A=25^\circ\text{C}$, Input: $t_R, t_F \leq 3\text{ns}$; $P_{RR} \leq 1\text{MHz}$)

PARAMETER	SYMBOL	TEST CONDITIONS	MIN	TYP	MAX	UNIT
Propagation delay time Input (A or B) to output(Y)	t_{PLH}	$V_{CC}=3.3V \pm 0.3V, C_L=15\text{pF}$		6.2	8.8	ns
	t_{PHL}			6.2	8.8	ns
	t_{PLH}	$V_{CC}=3.3V \pm 0.3V, C_L=50\text{pF}$		8.7	12.3	ns
	t_{PHL}			8.7	12.3	ns
Propagation delay time Input (A or B) to output(Y)	t_{PLH}	$V_{CC}=5V \pm 0.5V, C_L=15\text{pF}$		4.3	5.9	ns
	t_{PHL}			4.3	5.9	ns
	t_{PLH}	$V_{CC}=5V \pm 0.5V, C_L=50\text{pF}$		5.8	7.9	ns
	t_{PHL}			5.8	7.9	ns

■ OPERATING CHARACTERISTICS ($T_A=25^\circ\text{C}$)

PARAMETER	SYMBOL	TEST CONDITIONS	MIN	TYP	MAX	UNIT
Power Dissipation Capacitance	C_{PD}	No load, $V_{CC}=5V, f=1\text{MHz}$		18		pF

■ TEST CIRCUIT AND WAVEFORMS

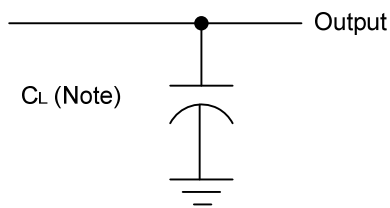

Note: CL includes probe and jig capacitance.

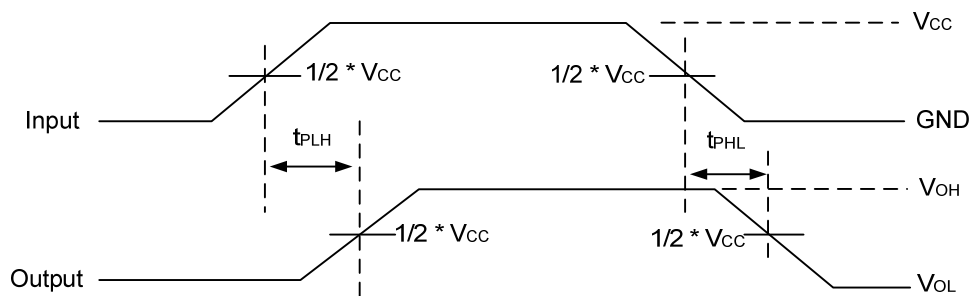

UTC assumes no responsibility for equipment failures that result from using products at values that exceed, even momentarily, rated values (such as maximum ratings, operating condition ranges, or other parameters) listed in products specifications of any and all UTC products described or contained herein. UTC products are not designed for use in life support appliances, devices or systems where malfunction of these products can be reasonably expected to result in personal injury. Reproduction in whole or in part is prohibited without the prior written consent of the copyright owner. The information presented in this document does not form part of any quotation or contract, is believed to be accurate and reliable and may be changed without notice.