

**FEATURES**

- LOW COST
- WIDE BANDWIDTH - 1.1 Mhz
- HIGH OUTPUT CURRENT - 1A PER AMPLIFIER
- WIDE COMMON MODE RANGE Includes negative supply
- WIDE SUPPLY VOLTAGE RANGE Single supply: 5V to 40V Split supplies:  $\pm 2.5V$  to  $\pm 20V$
- LOW QUIESCIENT CURRENT
- VERY LOW DISTORTION

**APPLICATIONS**

- HALF AND FULL BRIDGE MOTOR DRIVERS
- AUDIO POWER AMPLIFIER
  - Stereo - 11.3W RMS per amplifier
  - Bridge - 22.6W RMS per two amplifiers
  - Two Bridges - 45.2W RMS per package
- 3 PHASE MOTOR DRIVER
  - 3 Channels - 33.9W RMS per package
- IDEAL FOR SINGLE SUPPLY SYSTEMS
  - 5V - Peripherals
  - 12V - Automotive
  - 28V - Avionic
- PACKAGING OPTIONS
  - 20-Pin PSOP, JEDEC MO-166-AB (PA62DK)

**DESCRIPTION**

The amplifier design is a dual power op amp on a single monolithic die. The quad output PA62 combines two dual op amp die in a single PSOP package. This approach provides a cost-effective solution to applications where multiple amplifiers are required or a bridge configuration is needed. Four independent amplifiers coupled with low quiescent current and very low THD makes this an ideal low-distortion 4-channel audio amplifier for applications such as laptops and computer speakers.

The quad output PA62DK is available in a surface mount 20-pin PSOP, JEDEC MO-166-AB package. The heat slug of the DK package is tied to -Vs.

Built-in thermal shutdown allows the devices to self-protect

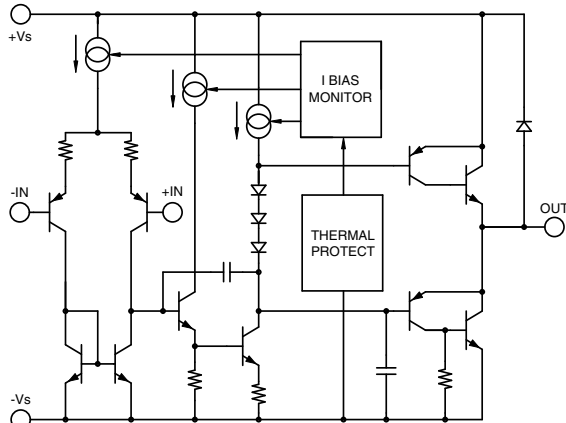
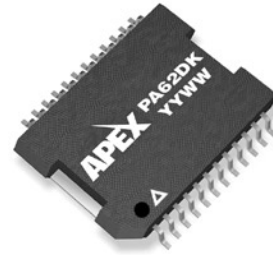

FIGURE 1. Equivalent schematic (one channel)



20-PIN PSOP PACKAGE STYLE DK

against thermal overloads. Care must be exercised to observe the Safe Operating Area (SOA) curve and proper heatsinking will ensure maximum reliability.

The wide common mode input range includes the negative rail, facilitating single supply applications. This makes it possible to have a ground-based input driving a single supply amplifier with ground acting as the second or bottom supply of the amplifier.

FIGURE 2. Bi-directional speed control from a single supply

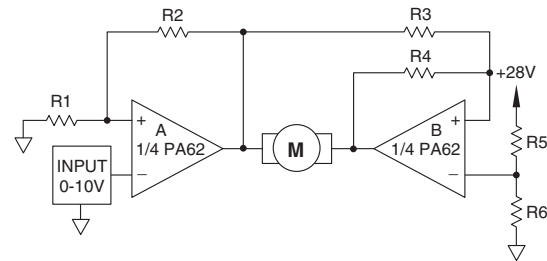

**TYPICAL APPLICATION**

R1 and R2 set up Amplifier A as non-inverting. Amplifier B is set up as a unity gain inverter driven from the output of Amplifier A. Note that Amplifier B inverts the signals about the reference node, which is set at mid-supply by R5 and R6. When the command input is midrange, so is the output of Amplifier A. Since this is also equivalent to the reference node voltage, the output of Amplifier B is the same resulting in 0V across the motor. Inputs more positive than 5V result in motor current flow from left to right (see Figure 2). Inputs less than 5V drive the motor in the opposite direction.

The amplifiers are especially well-suited for applications such as this. The extended common mode range allows command inputs as low as 0V. The output swing lets it drive within 2V of the supply at an output of 1A. This means that a command input that ranges from 0 to 10V will drive a 24V motor from full scale CCW to full scale CW at  $\pm 1A$ .

FIGURE 3. External Connections

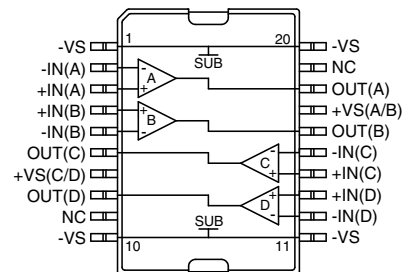

### ABSOLUTE MAXIMUM RATINGS

SUPPLY VOLTAGE, total	5V to 40V
OUTPUT CURRENT	SOA
POWER DISSIPATION, internal (1 amplifier)	15.88W
POWER DISSIPATION, internal (2 amplifiers) <sup>4</sup>	24.21W
POWER DISSIPATION, internal (3 amplifiers) <sup>4</sup>	36.90W
POWER DISSIPATION, internal (4 amplifiers) <sup>4</sup>	45.20W
INPUT VOLTAGE, differential	±Vs
INPUT VOLTAGE, common mode	+Vs, -Vs, -5V
JUNCTION TEMPERATURE, max <sup>1</sup>	150°C
TEMPERATURE, pin solder - 10 secs max.	220°C
TEMP RANGE STORAGE	-55°C to 150°C
OPERATING TEMP RANGE, case <sup>1</sup>	-40°C to 125°C

### SPECIFICATIONS (PER AMPLIFIER)

PARAMETER	TEST CONDITIONS <sup>1,2</sup>	MIN	TYP	MAX	UNTS
<b>INPUT</b>					
OFFSET VOLTAGE, initial			1	15	mV
OFFSET VOLTAGE, vs. temperature	Full temp range		20		μV/°C
BIAS CURRENT, initial			100	500	nA
COMMON MODE RANGE	Full temp range	-Vs		+Vs	V
COMMON MODE REJECTION, DC		60	90		dB
POWER SUPPLY REJECTION	Full temp range	60	90		dB
CHANNEL SEPARATION	I <sub>OUT</sub> = 500mA, f = 1kHz	50	68		dB
INPUT NOISE VOLTAGE	R <sub>s</sub> = 100Ω, f = 1 to 100kHz		22		nV/√Hz
<b>GAIN</b>					
OPEN LOOP GAIN	V <sub>o</sub> = ±10V, R <sub>L</sub> = 2.0KΩ	89	100		dB
GAIN BANDWIDTH PRODUCT	f = 100kHz, C <sub>L</sub> = 100pF, R <sub>L</sub> = 2.0KΩ		0.9	1.4	MHz
PHASE MARGIN	Full temp range		65		°C
POWER BANDWIDTH	V <sub>o</sub> (P-P) = 28V		13.6		kHz
<b>OUTPUT</b>					
CURRENT, peak				1.0	A
SLEW RATE		1.0	1.4		V/μS
VOLTAGE SWING	Full temp range, I <sub>o</sub> = 100mA	V <sub>s</sub>   -1.1	V <sub>s</sub>   -0.8		V
VOLTAGE SWING	Full temp range, I <sub>o</sub> = 1A	V <sub>s</sub>   -1.8	V <sub>s</sub>   -1.4		V
HARMONIC DISTORTION	A <sub>v</sub> = 1, R <sub>L</sub> = 50Ω, V <sub>o</sub> = .5VRMS, f = 1kHz		.02		%
<b>POWER SUPPLY</b>					
VOLTAGE, V <sub>SS</sub> <sup>3</sup>		5	30	40	V
CURRENT, quiescent +Vs (A/B)			8	10	mA
CURRENT, quiescent +Vs (C/D)			8	10	mA
CURRENT, quiescent total			16	20	mA
<b>THERMAL</b>					
RESISTANCE, junction to case					
DC, 1 amplifier			7.16	7.87	°C/W
DC, 2 amplifiers <sup>4</sup>			4.69	5.16	°C/W
DC, 3 amplifiers <sup>4</sup>			3.08	3.39	°C/W
DC, 4 amplifiers <sup>4</sup>			2.51	2.77	°C/W
AC, 1 amplifier			5.37	5.90	°C/W
AC, 2 amplifiers <sup>4</sup>			3.52	3.87	°C/W
AC, 3 amplifiers <sup>4</sup>			2.31	2.54	°C/W
AC, 4 amplifiers <sup>4</sup>			1.89	2.07	°C/W
RESISTANCE, junction to air <sup>6</sup>					
			25		°C/W

- Notes
1. Long term operation at the maximum junction temperature will result in reduced product life. Derate internal power dissipation to achieve high MTTF.
  2. Unless otherwise noted, the following conditions apply: ±V<sub>s</sub> = ±15V, T<sub>c</sub> = 25°C.
  3. +V<sub>s</sub> and -V<sub>s</sub> denote the positive and negative rail respectively. V<sub>SS</sub> denotes total rail-to-rail supply.
  4. Rating applies when power dissipation is equal in each of the amplifiers. Power and thermal ratings are based on two separate dual monolithic power op-amps on one integrated copper heatslug. Amplifiers A and B are combined on one monolithic die while amplifiers C and D are on the other.
  5. If -V<sub>s</sub> is disconnected before +V<sub>s</sub>, a diode between -V<sub>s</sub> and ground is recommended to avoid damage.
  6. Rating applies when the heatslug of the DK package is soldered to a minimum of 1 square inch foil area of a printed circuit board.

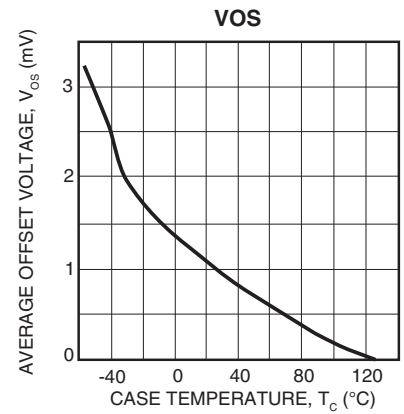
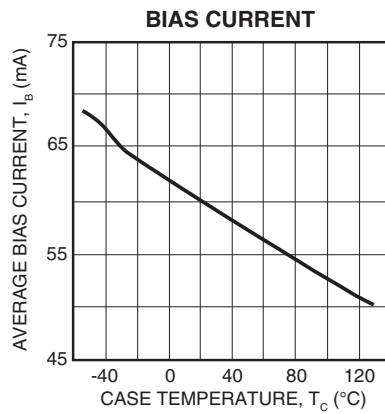
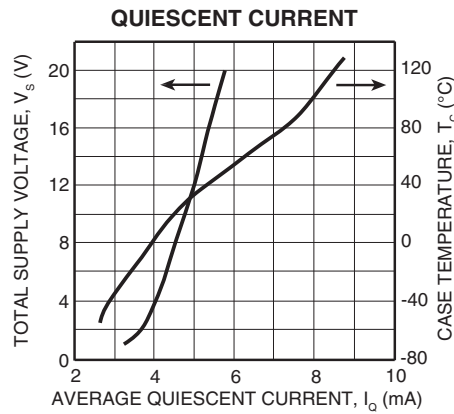

PHASE MARGIN vs. OUTPUT LOAD CAPACITANCE

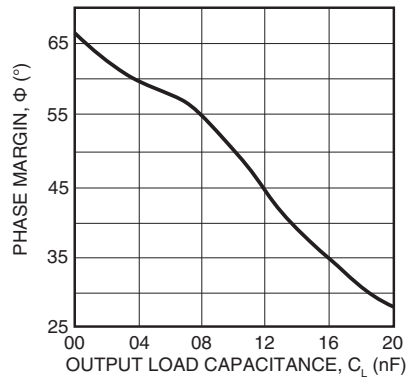

VOLTAGE GAIN & PHASE vs. FREQUENCY

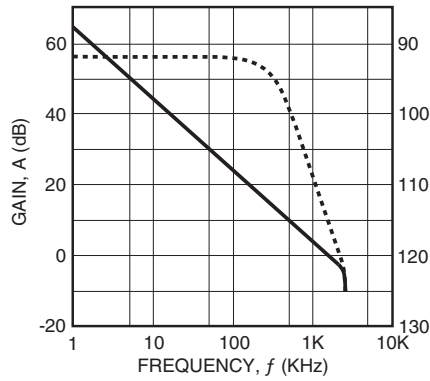

OUTPUT VOLTAGE SWING

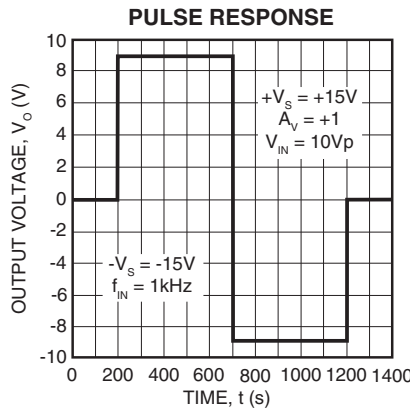
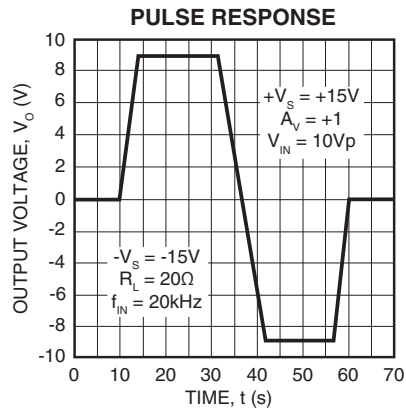
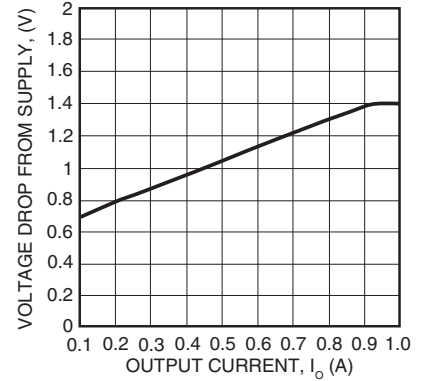

## TYPICAL APPLICATION (CONT.)

The PA62 can be used in a three amplifier configuration for a three phase inverter or motor as shown in Figure 4.

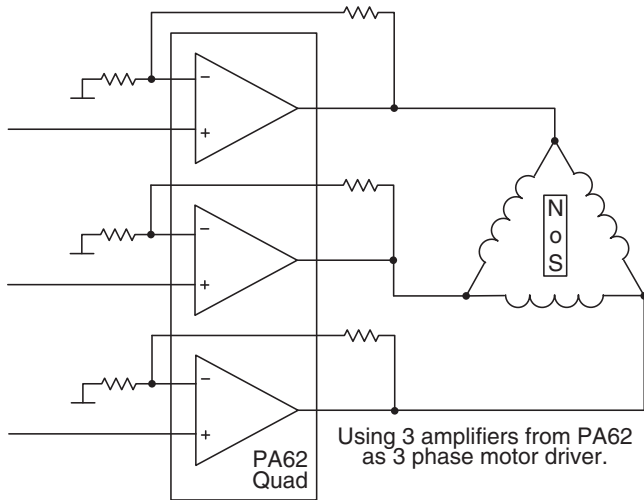

FIGURE 4. 3 Phase Inverter

## GENERAL

Please read Application Note 1 "General Operating Considerations" which covers stability, supplies, heatsinking, mounting, SOA interpretation, and specification interpretation. Visit [www.apexmicrotech.com](http://www.apexmicrotech.com) for design tools that help automate tasks such as calculations for stability, internal power dissipation, heatsink selection; Apex's complete Application Notes library; Technical Seminar Workbook; and Evaluation Kits.

## STABILITY CONSIDERATIONS

All monolithic power op amps use output stage topologies that present special stability problems. This is primarily due to non-complementary (both devices are NPN) output stages with a mismatch in gain and phase response for different polarities of output current. It is difficult for the op amp manufacturer to optimize compensation for all operating conditions.

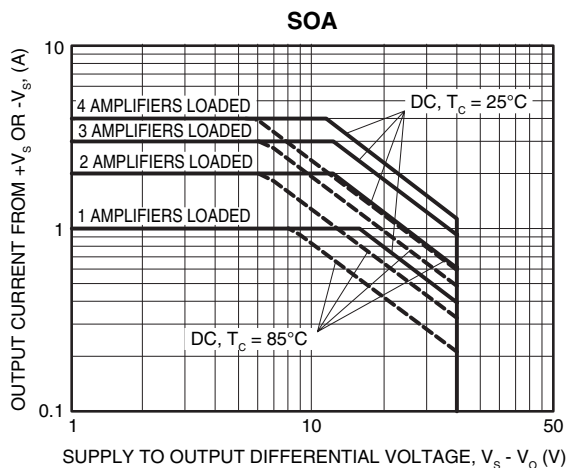

## SAFE OPERATING AREA (SOA)

The SOA curves combine the effect of all limits for this power op amp. For a given application, the direction and magnitude of the output current should be calculated or measured and checked against the SOA curves. This is simple for resistive loads but more complex for reactive and EMF generating loads. The following guidelines may save extensive analytical efforts.

## THERMAL CONSIDERATIONS

The PA62DK has a large exposed integrated copper heatslug to which the monolithic is directly attached. The solder connection of the heatslug to a minimum of 1 square inch foil area of the printed circuit board will result in thermal performance of 25°C/W junction to air rating of the PA62DK. Solder connection to an area of 1 to 2 square inches of foil is required for minimal power applications.

Where the PA62DK is used in higher power applications, it is necessary to use surface mount techniques of heatsinking. Surface mount techniques include the use of a surface mount fan in combination with a surface mount heatsink on the backside of the FR4/ PC board with through hole thermal vias. Other highly thermal conductive substrate board materials are available for maximum heat sinking.

The Power Derating graph shown below assumes that the power dissipation is equal in each of the amplifiers. Power and thermal ratings are based on two separate dual monolithic power op amps on one integrated copper heat slug. Amps A and B are combined on one monolithic die while amps C and D are combined on the other. This multi chip configuration provides superior thermal performance by isolating each of the dual amplifiers. When loading either of the dual amplifiers it is possible to achieve better thermal performance by loading any combination of amplifiers (A or B) + (C or D).

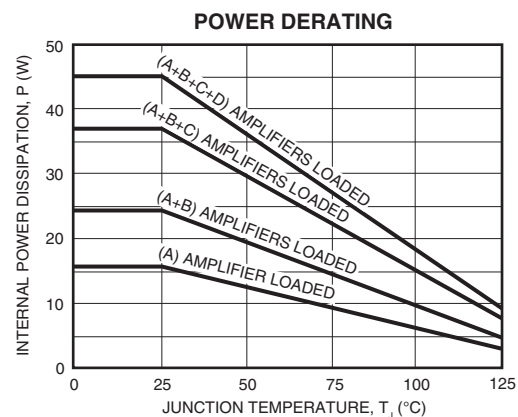

## MOUNTING PRECAUTIONS

1. Always use a heat sink. Even unloaded the PA62DK can dissipate up to .8 watts.
2. Avoid bending the leads. Such action can lead to internal damage.