

ICL351-LS

3-phase VRD/POL Inductor

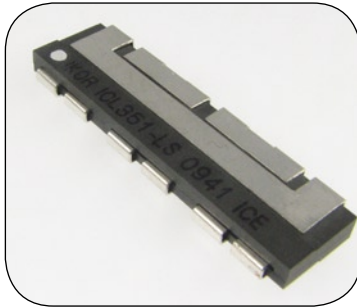

Applications

- VRDs (Imbedded)
- VRMs (Module)
- POLs
- VRM 10.x / VRM11 based designs
- DDR2/3 memory

Features

- Design for use with IKOR's proprietary coupled inductor multi-phase DC-DC converter topology
- Low height and small size allows use in both imbedded (VRD) and module (VRM) applications
- Integrated design lowers cost and simplifies assembly

The ICL351-LS, a 3-phase inductor assembly using IKOR's coupled inductor technology, solves the most pressing problem facing IA-32 VRDs. This patented technology solves the trade-off between efficiency and elimination of bulk capacitors by dramatically lowering the VRM output inductance while using industry-standard components and relatively low switching frequencies. This technology provides superior transient response performance to higher frequency solutions due to the unique method of coupling between phases, and enables high-current designs with little or no electrolytic output bypass capacitance. The ICL351-LS 3-phase coupled inductor assembly is designed for VRD applications. Its integrated design allows it to fit the inductors very close to the CPU socket in VRD applications. This device can also be used in high current System VRM (SVRM) applications where small size, high efficiency, and low total BOM cost is critical.

Inductor Assembly Electrical Specifications

Parameter	Test Conditions	Min	Typ	Max	Unit
L_S (1-6)	1.0 Vrms @ 500 kHz	471	589	707	nH
L_S (2-3)	1.0 Vrms @ 500 kHz	471	589	707	nH
L_S (4-5)	1.0 Vrms @ 500 kHz	471	589	707	nH
L_L (1-6) short 2,3	1.0 Vrms @ 1MHz	384	480	576	nH
L_L (1-6) short 4,5	1.0 Vrms @ 1MHz	384	480	576	nH
L_L (2-3) short 4,5	1.0 Vrms @ 1MHz	379	474	569	nH
DCR (1-6)	25° C	1.06	1.18	1.3	mΩ
DCR (2-3)	25° C	0.61	0.68	0.75	mΩ
DCR (4-5)	25° C	0.61	0.68	0.75	mΩ

ICL351-LS VRD/POL Inductor



Inductor Assembly

units: mm

Front View

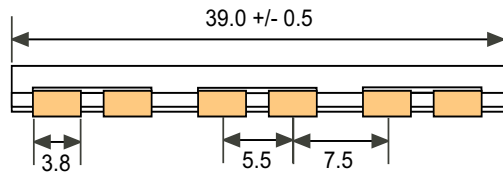

Top View

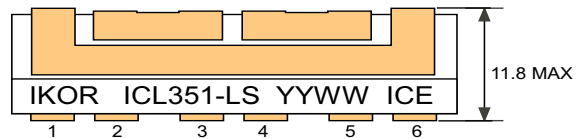

Side View

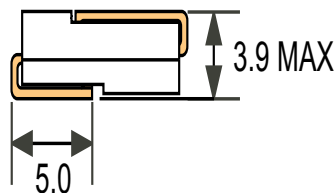

Schematic

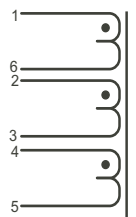

Layout

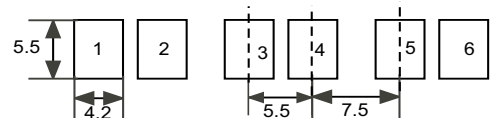

units: mm

Application Schematic

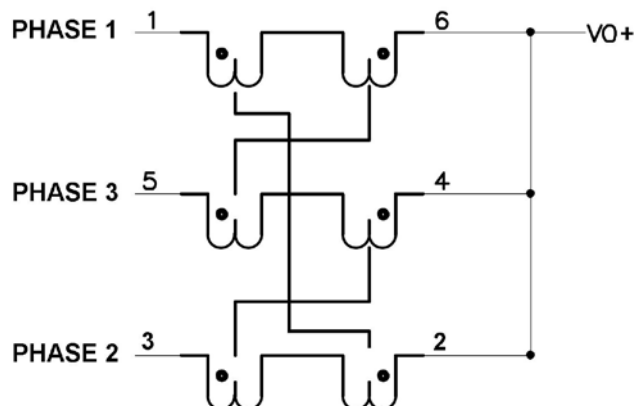

The technology utilized in conjunction with the coupled inductor ("the CL") described in this data sheet includes intellectual property (the "IP") owned by iWatt, Inc. and is covered by one or more of the following U.S. patents: 6,545,450; 6,686,727; 6,696,823. In connection with the end customer's purchase of the CL from "ICE Components, Inc.", the end customer is hereby granted a non-exclusive, worldwide, royalty-free license (without rights to sublicense) to use and incorporate the IP in the end customer's product that also incorporates the CL. In no way does this license extend to customer end products which do not incorporate the CL to implement the IP.

Specifications subject to change without notice.