

TOSHIBA CMOS Digital Integrated Circuit Silicon Monolithic

# TC74VCX16245FT

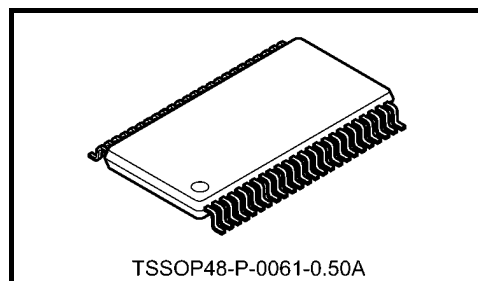
## Low-Voltage 16-Bit Bus Transceiver with 3.6-V Tolerant Inputs and Outputs

The TC74VCX16245FT is a high-performance CMOS 16-bit bus transceiver. Designed for use in 1.8-V, 2.5-V or 3.3-V systems, it achieves high-speed operation while maintaining the CMOS low power dissipation.

It is also designed with overvoltage tolerant inputs and outputs up to 3.6 V.

This 16-bit bus transceiver is controlled by direction control (DIR) inputs and output enable ( $\overline{OE}$ ) inputs which are common to each byte. It can be used as two 8-bit transceivers or one 16-bit transceiver. The direction of data transmission is determined by the level of the DIR inputs. The  $\overline{OE}$  inputs can be used to disable the device so that the busses are effectively isolated.

All inputs are equipped with protection circuits against static discharge.



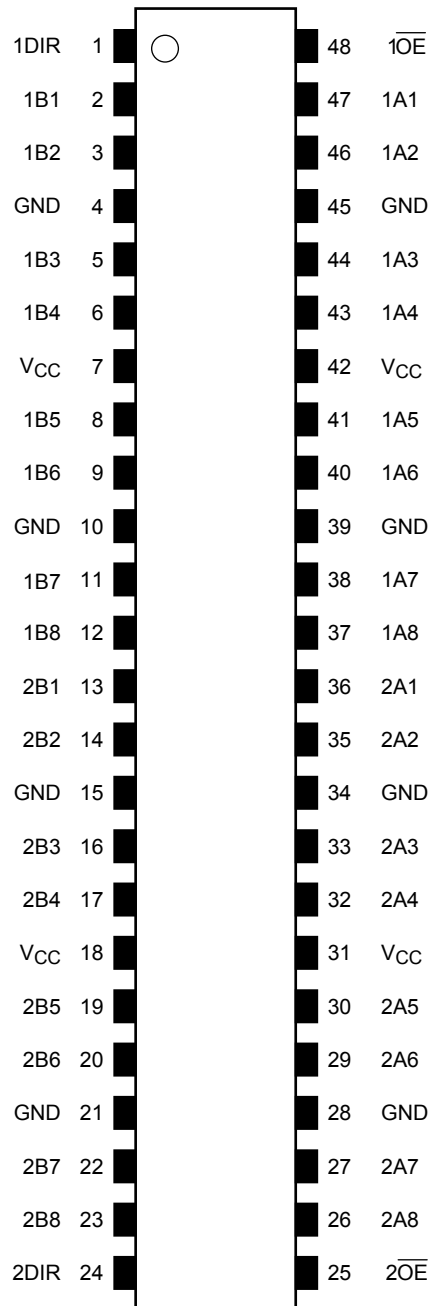
Weight: 0.25 g (typ.)

### Features (Note)

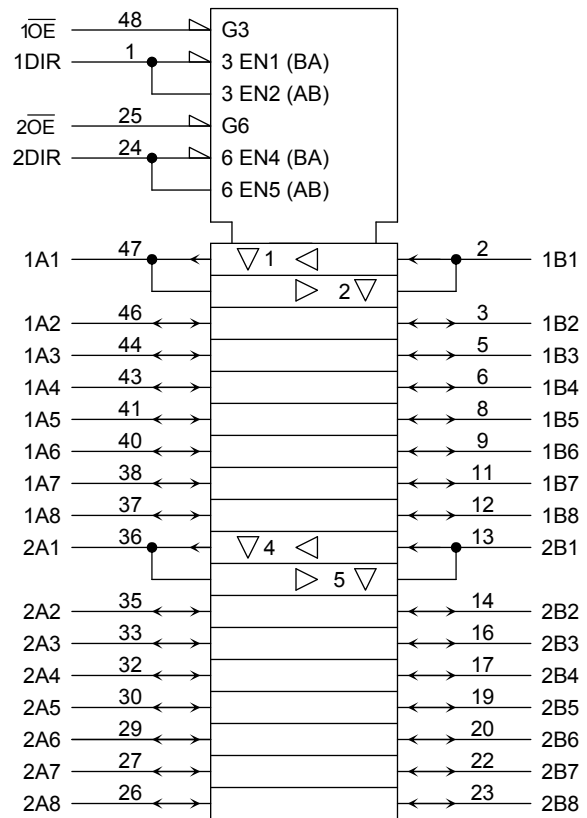
- Low-voltage operation:  $V_{CC} = 1.8$  to  $3.6$  V
- High-speed operation:  $t_{pd} = 2.5$  ns (max) ( $V_{CC} = 3.0$  to  $3.6$  V)  
:  $t_{pd} = 3.0$  ns (max) ( $V_{CC} = 2.3$  to  $2.7$  V)  
:  $t_{pd} = 5.0$  ns (max) ( $V_{CC} = 1.8$  V)
- Output current:  $I_{OH}/I_{OL} = \pm 24$  mA (min) ( $V_{CC} = 3.0$  V)  
:  $I_{OH}/I_{OL} = \pm 18$  mA (min) ( $V_{CC} = 2.3$  V)  
:  $I_{OH}/I_{OL} = \pm 6$  mA (min) ( $V_{CC} = 1.8$  V)
- Latch-up performance:  $-300$  mA
- ESD performance: Machine model  $\geq \pm 200$  V  
Human body model  $\geq \pm 2000$  V
- Package: TSSOP
- Bidirectional interface between 2.5 V and 3.3 V signals.
- 3.6-V tolerant function and power-down protection provided on all inputs and outputs

Note: Do not apply a signal to any bus pins when it is in the output mode. Damage may result.  
All floating (high impedance) bus pins must have their input level fixed by means of pull-up or pull-down resistors.

## Pin Assignment (top view)



## IEC Logic Symbol



**Truth Table**

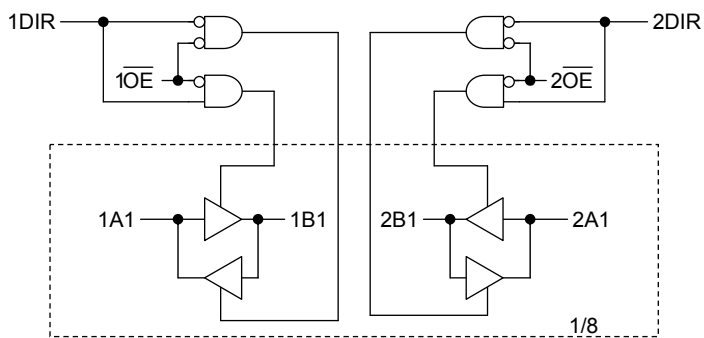
Inputs		Function		Outputs
$\overline{1OE}$	1DIR	Bus 1A1-1A8	Bus 1B1-1B8	
L	L	Output	Input	A = B
L	H	Input	Output	B = A
H	X	Z		Z

Inputs		Function		Outputs
$\overline{2OE}$	2DIR	Bus 2A1-2A8	Bus 2B1-2B8	
L	L	Output	Input	A = B
L	H	Input	Output	B = A
H	X	Z		Z

X: Don't care

Z: High impedance

**System Diagram**



## Absolute Maximum Ratings (Note 1)

Characteristics	Symbol	Rating	Unit
Power supply voltage	$V_{CC}$	-0.5 to 4.6	V
DC input voltage (DIR, $\overline{OE}$ )	$V_{IN}$	-0.5 to 4.6	V
DC bus I/O voltage	$V_{I/O}$	-0.5 to 4.6 (Note 2)	V
		-0.5 to $V_{CC} + 0.5$ (Note 3)	
Input diode current	$I_{IK}$	-50	mA
Output diode current	$I_{OK}$	$\pm 50$ (Note 4)	mA
DC output current	$I_{OUT}$	$\pm 50$	mA
Power dissipation	$P_D$	400	mW
DC $V_{CC}$ /ground current per supply pin	$I_{CC}/I_{GND}$	$\pm 100$	mA
Storage temperature	$T_{stg}$	-65 to 150	$^{\circ}C$

Note 1: Exceeding any of the absolute maximum ratings, even briefly, lead to deterioration in IC performance or even destruction.

Using continuously under heavy loads (e.g. the application of high temperature/current/voltage and the significant change in temperature, etc.) may cause this product to decrease in the reliability significantly even if the operating conditions (i.e. operating temperature/current/voltage, etc.) are within the absolute maximum ratings and the operating ranges.

Please design the appropriate reliability upon reviewing the Toshiba Semiconductor Reliability Handbook ("Handling Precautions"/"Derating Concept and Methods") and individual reliability data (i.e. reliability test report and estimated failure rate, etc).

Note 2: OFF state

Note 3: High or low state.  $I_{OUT}$  absolute maximum rating must be observed.

Note 4:  $V_{OUT} < GND$ ,  $V_{OUT} > V_{CC}$

## Operating Ranges (Note 1)

Characteristics	Symbol	Rating	Unit
Power supply voltage	$V_{CC}$	1.8 to 3.6	V
		1.2 to 3.6 (Note 2)	
Input voltage (DIR, $\overline{OE}$ )	$V_{IN}$	-0.3 to 3.6	V
Bus I/O voltage	$V_{I/O}$	0 to 3.6 (Note 3)	V
		0 to $V_{CC}$ (Note 4)	
Output current	$I_{OH}/I_{OL}$	$\pm 24$ (Note 5)	mA
		$\pm 18$ (Note 6)	
		$\pm 6$ (Note 7)	
Operating temperature	$T_{opr}$	-40 to 85	$^{\circ}C$
Input rise and fall time	$dt/dv$	0 to 10 (Note 8)	ns/V

Note 1: The operating ranges must be maintained to ensure the normal operation of the device. Unused inputs and bus inputs must be tied to either  $V_{CC}$  or GND. Please connect both bus inputs and the bus outputs with  $V_{CC}$  or GND when the I/O of the bus terminal changes by the function. In this case, please note that the output is not short-circuited.

Note 2: Data retention only

Note 3: OFF state

Note 4: High or low state

Note 5:  $V_{CC} = 3.0$  to  $3.6$  V

Note 6:  $V_{CC} = 2.3$  to  $2.7$  V

Note 7:  $V_{CC} = 1.8$  V

Note 8:  $V_{IN} = 0.8$  to  $2.0$  V,  $V_{CC} = 3.0$  V

**Electrical Characteristics**

**DC Characteristics (Ta = -40 to 85°C, 2.7 V < VCC ≤ 3.6 V)**

Characteristics		Symbol	Test Condition		VCC (V)	Min	Max	Unit
Input voltage	H-level	V <sub>IH</sub>	—		2.7 to 3.6	2.0	—	V
	L-level	V <sub>IL</sub>	—		2.7 to 3.6	—	0.8	
Output voltage	H-level	V <sub>OH</sub>	V <sub>IN</sub> = V <sub>IH</sub> or V <sub>IL</sub>	I <sub>OH</sub> = -100 μA	2.7 to 3.6	V <sub>CC</sub> - 0.2	—	V
				I <sub>OH</sub> = -12 mA	2.7	2.2	—	
				I <sub>OH</sub> = -18 mA	3.0	2.4	—	
				I <sub>OH</sub> = -24 mA	3.0	2.2	—	
	L-level	V <sub>OL</sub>	V <sub>IN</sub> = V <sub>IH</sub> or V <sub>IL</sub>	I <sub>OL</sub> = 100 μA	2.7 to 3.6	—	0.2	
				I <sub>OL</sub> = 12 mA	2.7	—	0.4	
				I <sub>OL</sub> = 18 mA	3.0	—	0.4	
				I <sub>OL</sub> = 24 mA	3.0	—	0.55	
Input leakage current		I <sub>IN</sub>	V <sub>IN</sub> = 0 to 3.6 V		2.7 to 3.6	—	±5.0	μA
3-state output OFF state current		I <sub>OZ</sub>	V <sub>IN</sub> = V <sub>IH</sub> or V <sub>IL</sub> V <sub>OUT</sub> = 0 to 3.6 V		2.7 to 3.6	—	±10.0	μA
Power-off leakage current		I <sub>OFF</sub>	V <sub>IN</sub> , V <sub>OUT</sub> = 0 to 3.6 V		0	—	10.0	μA
Quiescent supply current		I <sub>CC</sub>	V <sub>IN</sub> = V <sub>CC</sub> or GND		2.7 to 3.6	—	20.0	μA
			V <sub>CC</sub> ≤ (V <sub>IN</sub> , V <sub>OUT</sub> ) ≤ 3.6 V		2.7 to 3.6	—	±20.0	
Increase in I <sub>CC</sub> per input		ΔI <sub>CC</sub>	V <sub>IH</sub> = V <sub>CC</sub> - 0.6 V		2.7 to 3.6	—	750	

**DC Characteristics (Ta = -40 to 85°C, 2.3 V ≤ VCC ≤ 2.7 V)**

Characteristics		Symbol	Test Condition		VCC (V)	Min	Max	Unit
Input voltage	H-level	V <sub>IH</sub>	—		2.3 to 2.7	1.6	—	V
	L-level	V <sub>IL</sub>	—		2.3 to 2.7	—	0.7	
Output voltage	H-level	V <sub>OH</sub>	V <sub>IN</sub> = V <sub>IH</sub> or V <sub>IL</sub>	I <sub>OH</sub> = -100 μA	2.3 to 2.7	V <sub>CC</sub> - 0.2	—	V
				I <sub>OH</sub> = -6 mA	2.3	2.0	—	
				I <sub>OH</sub> = -12 mA	2.3	1.8	—	
				I <sub>OH</sub> = -18 mA	2.3	1.7	—	
	L-level	V <sub>OL</sub>	V <sub>IN</sub> = V <sub>IH</sub> or V <sub>IL</sub>	I <sub>OL</sub> = 100 μA	2.3 to 2.7	—	0.2	
				I <sub>OL</sub> = 12 mA	2.3	—	0.4	
				I <sub>OL</sub> = 18 mA	2.3	—	0.6	
Input leakage current		I <sub>IN</sub>	V <sub>IN</sub> = 0 to 3.6 V		2.3 to 2.7	—	±5.0	μA
3-state output OFF state current		I <sub>OZ</sub>	V <sub>IN</sub> = V <sub>IH</sub> or V <sub>IL</sub> V <sub>OUT</sub> = 0 to 3.6 V		2.3 to 2.7	—	±10.0	μA
Power-off leakage current		I <sub>OFF</sub>	V <sub>IN</sub> , V <sub>OUT</sub> = 0 to 3.6 V		0	—	10.0	μA
Quiescent supply current		I <sub>CC</sub>	V <sub>IN</sub> = V <sub>CC</sub> or GND		2.3 to 2.7	—	20.0	μA
			V <sub>CC</sub> ≤ (V <sub>IN</sub> , V <sub>OUT</sub> ) ≤ 3.6 V		2.3 to 2.7	—	±20.0	

## DC Characteristics (Ta = -40 to 85°C, 1.8 V ≤ VCC < 2.3 V)

Characteristics		Symbol	Test Condition		VCC (V)	Min	Max	Unit
Input voltage	H-level	V <sub>IH</sub>	—		1.8 to 2.3	0.7 × V <sub>CC</sub>	—	V
	L-level	V <sub>IL</sub>	—		1.8 to 2.3	—	0.2 × V <sub>CC</sub>	
Output voltage	H-level	V <sub>OH</sub>	V <sub>IN</sub> = V <sub>IH</sub> or V <sub>IL</sub>	I <sub>OH</sub> = -100 μA	1.8	V <sub>CC</sub> - 0.2	—	V
				I <sub>OH</sub> = -6 mA	1.8	1.4	—	
	L-level	V <sub>OL</sub>	V <sub>IN</sub> = V <sub>IH</sub> or V <sub>IL</sub>	I <sub>OL</sub> = 100 μA	1.8	—	0.2	
				I <sub>OL</sub> = 6 mA	1.8	—	0.3	
Input leakage current		I <sub>IN</sub>	V <sub>IN</sub> = 0 to 3.6 V		1.8	—	±5.0	μA
3-state output OFF state current		I <sub>OZ</sub>	V <sub>IN</sub> = V <sub>IH</sub> or V <sub>IL</sub> V <sub>OUT</sub> = 0 to 3.6 V		1.8	—	±10.0	μA
Power-off leakage current		I <sub>OFF</sub>	V <sub>IN</sub> , V <sub>OUT</sub> = 0 to 3.6 V		0	—	10.0	μA
Quiescent supply current		I <sub>CC</sub>	V <sub>IN</sub> = V <sub>CC</sub> or GND		1.8	—	20.0	μA
			V <sub>CC</sub> ≤ (V <sub>IN</sub> , V <sub>OUT</sub> ) ≤ 3.6 V		1.8	—	±20.0	

## AC Characteristics (Ta = -40 to 85°C, input: t<sub>r</sub> = t<sub>f</sub> = 2.0 ns, C<sub>L</sub> = 30 pF, R<sub>L</sub> = 500 Ω) (Note 1)

Characteristics		Symbol	Test Condition		VCC (V)	Min	Max	Unit
Propagation delay time	t <sub>pLH</sub> t <sub>pHL</sub>	Figure 1, Figure 2	1.8	1.5	5.0	ns		
			2.5 ± 0.2	1.0	3.0			
			3.3 ± 0.3	0.8	2.5			
3-state output enable time	t <sub>pZL</sub> t <sub>pZH</sub>	Figure 1, Figure 3	1.8	1.5	7.5	ns		
			2.5 ± 0.2	1.0	4.9			
			3.3 ± 0.3	0.8	3.8			
3-state output disable time	t <sub>pLZ</sub> t <sub>pHZ</sub>	Figure 1, Figure 3	1.8	1.5	5.5	ns		
			2.5 ± 0.2	1.0	4.2			
			3.3 ± 0.3	0.8	3.7			
Output to output skew	t <sub>osLH</sub> t <sub>osHL</sub>	(Note 2)	1.8	—	0.5	ns		
			2.5 ± 0.2	—	0.5			
			3.3 ± 0.3	—	0.5			

Note 1: For C<sub>L</sub> = 50 pF, add approximately 300 ps to the AC maximum specification.

Note 2: Parameter guaranteed by design.

(t<sub>osLH</sub> = |t<sub>pLHm</sub> - t<sub>pLHn</sub>|, t<sub>osHL</sub> = |t<sub>pHLm</sub> - t<sub>pHLn</sub>|)

## Dynamic Switching Characteristics (Ta = 25°C, input: tr = tf = 2.0 ns, CL = 30 pF)

Characteristics	Symbol	Test Condition	VCC (V)	Typ.	Unit
Quiet output maximum dynamic VOL	VOLP	V <sub>IH</sub> = 1.8 V, V <sub>IL</sub> = 0 V (Note)	1.8	0.25	V
		V <sub>IH</sub> = 2.5 V, V <sub>IL</sub> = 0 V (Note)	2.5	0.6	
		V <sub>IH</sub> = 3.3 V, V <sub>IL</sub> = 0 V (Note)	3.3	0.8	
Quiet output minimum dynamic VOL	VOLV	V <sub>IH</sub> = 1.8 V, V <sub>IL</sub> = 0 V (Note)	1.8	-0.25	V
		V <sub>IH</sub> = 2.5 V, V <sub>IL</sub> = 0 V (Note)	2.5	-0.6	
		V <sub>IH</sub> = 3.3 V, V <sub>IL</sub> = 0 V (Note)	3.3	-0.8	
Quiet output minimum dynamic VOH	VOHV	V <sub>IH</sub> = 1.8 V, V <sub>IL</sub> = 0 V (Note)	1.8	1.5	V
		V <sub>IH</sub> = 2.5 V, V <sub>IL</sub> = 0 V (Note)	2.5	1.9	
		V <sub>IH</sub> = 3.3 V, V <sub>IL</sub> = 0 V (Note)	3.3	2.2	

Note: Parameter guaranteed by design.

## Capacitive Characteristics (Ta = 25°C)

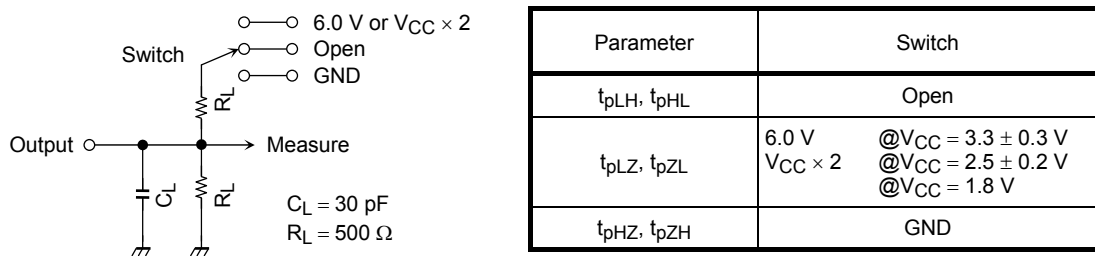
Characteristics	Symbol	Test Condition	VCC (V)	Typ.	Unit
Input capacitance	C <sub>IN</sub>	—	1.8, 2.5, 3.3	6	pF
Bus I/O capacitance	C <sub>I/O</sub>	—	1.8, 2.5, 3.3	7	pF
Power dissipation capacitance	C <sub>PD</sub>	f <sub>IN</sub> = 10 MHz (Note)	1.8, 2.5, 3.3	20	pF

Note: C<sub>PD</sub> is defined as the value of the internal equivalent capacitance which is calculated from the operating current consumption without load.

Average operating current can be obtained by the equation:

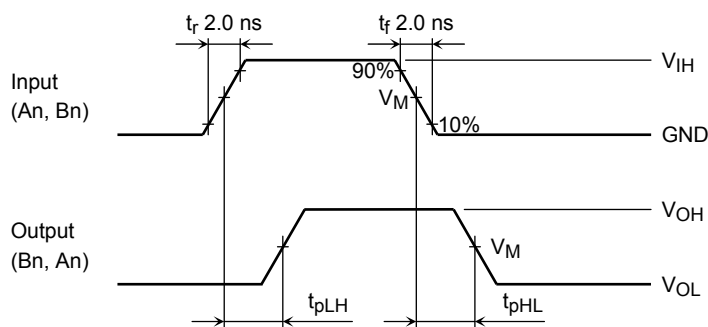
$$I_{CC(opr)} = C_{PD} \cdot V_{CC} \cdot f_{IN} + I_{CC}/16 \text{ (per bit)}$$

**AC Test Circuit**

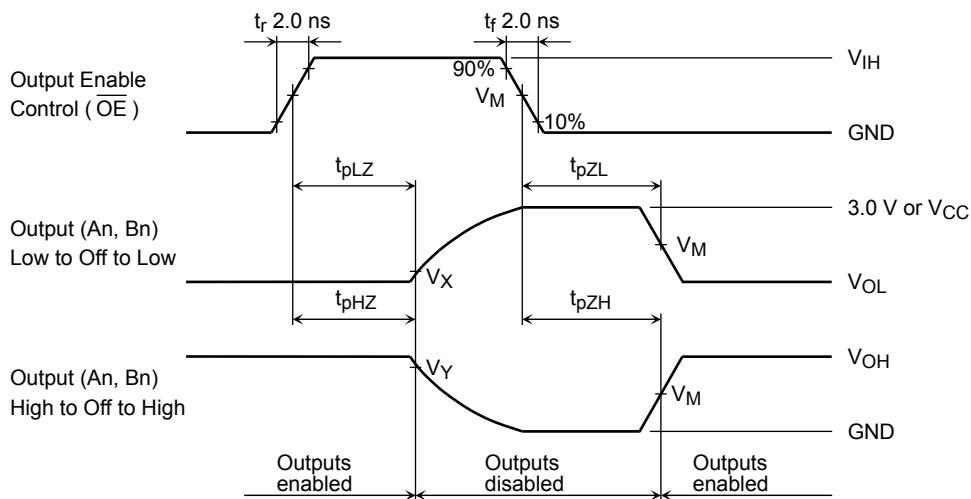


**Figure 1**

**AC Waveform**



**Figure 2  $t_{pLH}$ ,  $t_{pHL}$**



**Figure 3  $t_{pLZ}$ ,  $t_{pHZ}$ ,  $t_{pZL}$ ,  $t_{pZH}$**

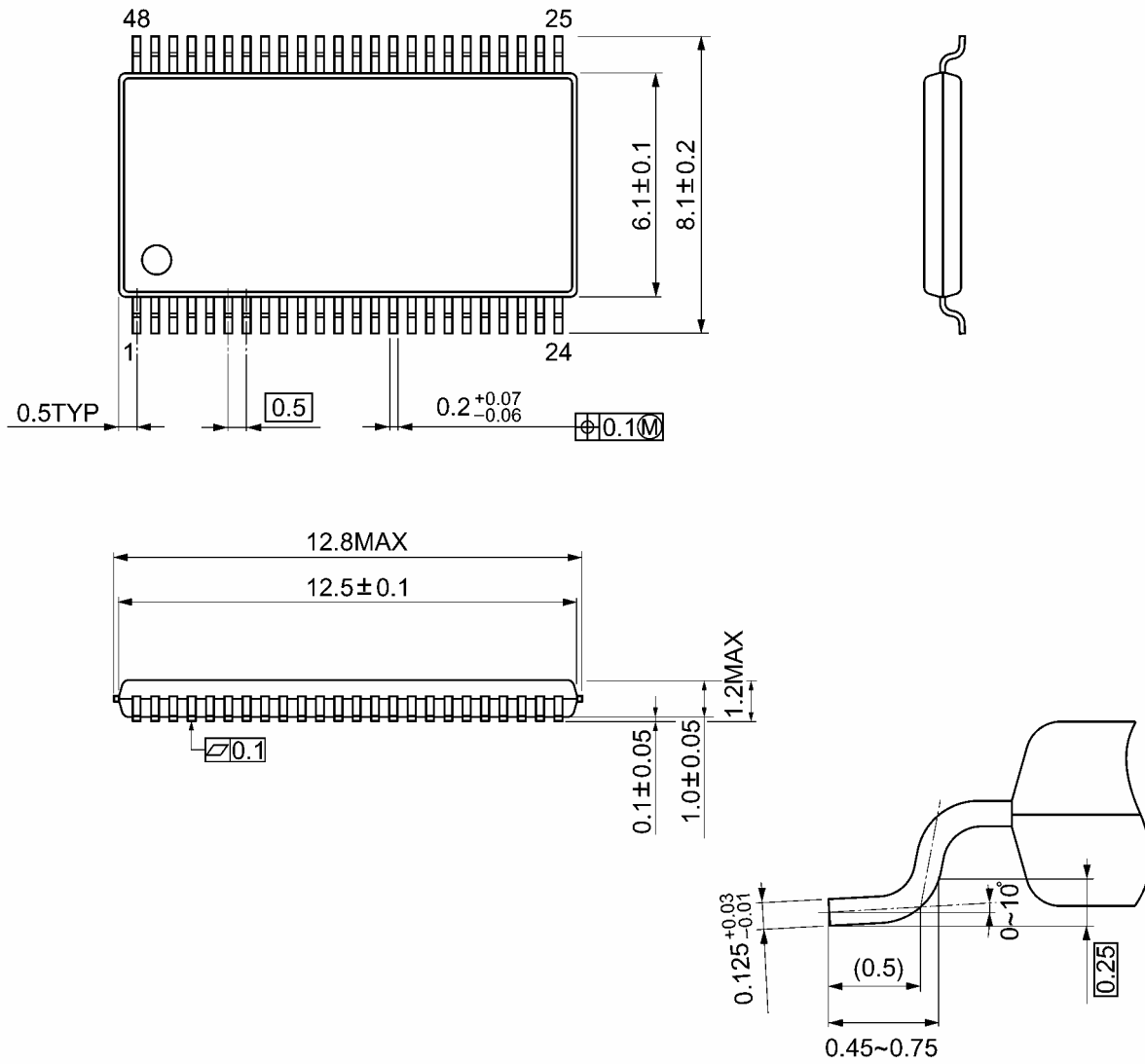
Symbol	$V_{CC}$		
	$3.3 \pm 0.3$ V	$2.5 \pm 0.2$ V	1.8 V
$V_{IH}$	2.7 V	$V_{CC}$	$V_{CC}$
$V_M$	1.5 V	$V_{CC}/2$	$V_{CC}/2$
$V_X$	$V_{OL} + 0.3$ V	$V_{OL} + 0.15$ V	$V_{OL} + 0.15$ V
$V_Y$	$V_{OH} - 0.3$ V	$V_{OH} - 0.15$ V	$V_{OH} - 0.15$ V



**Package Dimensions**

TSSOP48-P-0061-0.50A

Unit: mm



Weight: 0.25 g (typ.)

**RESTRICTIONS ON PRODUCT USE**

20070701-EN

- The information contained herein is subject to change without notice.
- TOSHIBA is continually working to improve the quality and reliability of its products. Nevertheless, semiconductor devices in general can malfunction or fail due to their inherent electrical sensitivity and vulnerability to physical stress. It is the responsibility of the buyer, when utilizing TOSHIBA products, to comply with the standards of safety in making a safe design for the entire system, and to avoid situations in which a malfunction or failure of such TOSHIBA products could cause loss of human life, bodily injury or damage to property.  
In developing your designs, please ensure that TOSHIBA products are used within specified operating ranges as set forth in the most recent TOSHIBA products specifications. Also, please keep in mind the precautions and conditions set forth in the "Handling Guide for Semiconductor Devices," or "TOSHIBA Semiconductor Reliability Handbook" etc.
- The TOSHIBA products listed in this document are intended for usage in general electronics applications (computer, personal equipment, office equipment, measuring equipment, industrial robotics, domestic appliances, etc.). These TOSHIBA products are neither intended nor warranted for usage in equipment that requires extraordinarily high quality and/or reliability or a malfunction or failure of which may cause loss of human life or bodily injury ("Unintended Usage"). Unintended Usage include atomic energy control instruments, airplane or spaceship instruments, transportation instruments, traffic signal instruments, combustion control instruments, medical instruments, all types of safety devices, etc.. Unintended Usage of TOSHIBA products listed in this document shall be made at the customer's own risk.
- The products described in this document shall not be used or embedded to any downstream products of which manufacture, use and/or sale are prohibited under any applicable laws and regulations.
- Please contact your sales representative for product-by-product details in this document regarding RoHS compatibility. Please use these products in this document in compliance with all applicable laws and regulations that regulate the inclusion or use of controlled substances. Toshiba assumes no liability for damage or losses occurring as a result of noncompliance with applicable laws and regulations.