

HiPerFAST™ IGBT Lightspeed™ Series

IXGH 12N90C
IXGX 12N90C

$V_{CES} = 900 \text{ V}$
 $I_{C25} = 24 \text{ A}$
 $V_{CES(sat)} = 3.0 \text{ V}$
 $t_{fi(typ)} = 70 \text{ ns}$

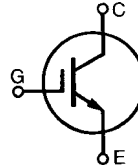

Symbol	Test Conditions	Maximum Ratings	
V_{CES}	$T_J = 25^\circ\text{C to } 150^\circ\text{C}$	900	V
V_{CGR}	$T_J = 25^\circ\text{C to } 150^\circ\text{C}; R_{GE} = 1 \text{ M}\Omega$	900	V
V_{GES}	Continuous	± 20	V
V_{GEM}	Transient	± 30	V
I_{C25}	$T_C = 25^\circ\text{C}$	24	A
I_{C90}	$T_C = 90^\circ\text{C}$	12	A
I_{CM}	$T_C = 25^\circ\text{C}, 1 \text{ ms}$	48	A
SSOA (RBSOA)	$V_{GE} = 15 \text{ V}, T_{VJ} = 125^\circ\text{C}, R_G = 33 \Omega$ Clamped inductive load	$I_{CM} = 24$ @ $0.8 V_{CES}$	A
P_C	$T_C = 25^\circ\text{C}$	100	W
T_J		-55 ... +150	$^\circ\text{C}$
T_{JM}		150	$^\circ\text{C}$
T_{stg}		-55 ... +150	$^\circ\text{C}$
M_d	Mounting torque with screw M3 Mounting torque with screw M3.5	0.45/4 Nm/lb.in. 0.55/5 Nm/lb.in.	
Maximum lead temperature for soldering 1.6 mm (0.062 in.) from case for 10 s		300	$^\circ\text{C}$
Weight		6	g

TO-247 (IXGH)

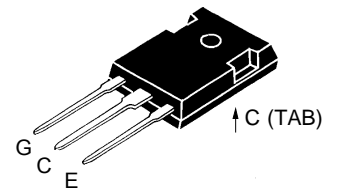

PLUS 247 (IXGX)

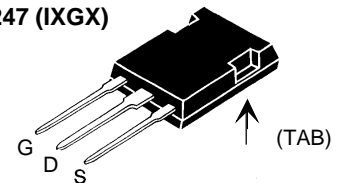

G = Gate, C = Collector,
E = Emitter, TAB = Collector

Features

- Very high frequency IGBT
- New generation HDMOS™ process
- International standard package
- High peak current handling capability

Applications

- PFC circuit
- AC motor speed control
- DC servo and robot drives
- Switch-mode and resonant-mode power supplies
- High power audio amplifiers

Advantages

- Fast switching speed
- High power density

Symbol	Test Conditions	Characteristic Values ($T_J = 25^\circ\text{C}$, unless otherwise specified)		
		min.	typ.	max.
BV_{CES}	$I_C = 250 \mu\text{A}, V_{GE} = 0 \text{ V}$	900		V
$V_{GE(th)}$	$I_C = 250 \mu\text{A}, V_{GE} = V_{GE}$	2.5		5.0 V
I_{CES}	$V_{CE} = V_{CES}, V_{GE} = 0 \text{ V}$			$T_J = 25^\circ\text{C}$: 100 μA $T_J = 125^\circ\text{C}$: 1.5 mA
I_{GES}	$V_{CE} = 0 \text{ V}, V_{GE} = \pm 20 \text{ V}$			$\pm 100 \text{ nA}$
$V_{CE(sat)}$	$I_C = I_{CE90}, V_{GE} = 15 \text{ V}$			3.0 V

Symbol	Test Conditions	Characteristic Values ($T_J = 25^\circ\text{C}$, unless otherwise specified)			
		min.	typ.	max.	
g_{fs}	$I_C = I_{C90}, V_{CE} = 10\text{ V}$, Pulse test, $t \leq 300\ \mu\text{s}$, duty cycle $\leq 2\%$	5	10	S	
C_{ies}	$V_{CE} = 25\text{ V}, V_{GE} = 0\text{ V}, f = 1\text{ MHz}$		780	pF	
C_{oes}			60	pF	
C_{res}			15	pF	
Q_g	$I_C = I_{C90}, V_{GE} = 15\text{ V}, V_{CE} = 0.5 V_{CES}$		33	nC	
Q_{ge}			10	nC	
Q_{gc}			12	nC	
$t_{d(on)}$	Inductive load, $T_J = 25^\circ\text{C}$ $I_C = I_{C90}, V_{GE} = 15\text{ V}$ $V_{CE} = 0.8 \cdot V_{CES}, R_G = R_{off} = 22\ \Omega$ Remarks: Switching times may increase for $V_{CE}(\text{Clamp}) > 0.8 \cdot V_{CES}$, higher T_J or increased R_G		20	ns	
t_{ri}			20	ns	
$t_{d(off)}$			135	200	ns
t_{fi}			70	180	ns
E_{off}			0.32	0.70	mJ
$t_{d(on)}$	Inductive load, $T_J = 125^\circ\text{C}$ $I_C = I_{C90}, V_{GE} = 15\text{ V}$ $V_{CE} = 0.8 \cdot V_{CES}, R_G = R_{off} = 22\ \Omega$ Remarks: Switching times may increase for $V_{CE}(\text{Clamp}) > 0.8 \cdot V_{CES}$, higher T_J or increased R_G		20	ns	
t_{ri}			20	ns	
E_{on}			0.15	mJ	
$t_{d(off)}$			200	ns	
t_{fi}			150	ns	
E_{off}		0.70	mJ		
R_{thJC}			1.25	K/W	
R_{thCK}	TO-247 PLUS 247	0.25 0.15		K/W K/W	

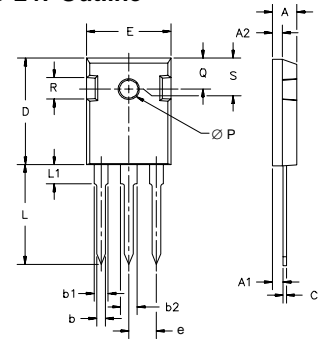
TO-247 Outline

Dim.	Millimeter		Inches	
	Min.	Max.	Min.	Max.
A	4.7	5.3	.185	.209
A ₁	2.2	2.54	.087	.102
A ₂	2.2	2.6	.087	.102
b	1.0	1.4	.040	.055
b ₁	1.65	2.13	.065	.084
b ₂	2.87	3.12	.113	.123
C	.4	.8	.016	.031
D	20.80	21.46	.819	.845
E	15.75	16.26	.610	.640
e	5.20	5.72	0.205	0.225
L	19.81	20.32	.780	.800
L1		4.50		.177
∅P	3.55	3.65	.140	.144
Q	5.89	6.40	0.232	0.252
R	4.32	5.49	.170	.216
S	6.15	BSC	.242	BSC

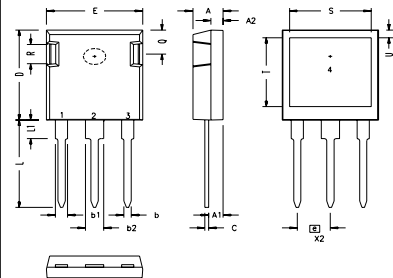
PLUS 247 Outline

SYM	INCHES		MILLIMETERS	
	MIN	MAX	MIN	MAX
A	.190	.205	4.83	5.21
A1	.090	.100	2.29	2.54
A2	.075	.085	1.91	2.16
b	.045	.055	1.14	1.40
b1	.075	.084	1.91	2.13
b2	.115	.123	2.92	3.12
C	.024	.031	0.61	0.80
D	.819	.840	20.80	21.34
E	.620	.635	15.75	16.13
e	.215 BSC		5.45 BSC	
L	.780	.800	19.81	20.32
L1	.150	.170	3.81	4.32
Q	.220	.244	5.59	6.20
R	.170	.190	4.32	4.83
S	.520	.540	13.21	13.72
T	.620	.640	15.75	16.26
U	.065	.080	1.65	2.03

- 1 - GATE
- 2 - DRAIN (COLLECTOR)
- 3 - SOURCE (EMITTER)
- 4 - NO CONNECTION

NOTE: This drawing will meet all dimensions requirement of JEDEC outline TO-247AD except screw hole.

IXYS reserves the right to change limits, test conditions, and dimensions.

Fig. 1. Saturation Voltage Characteristics @ 25°C

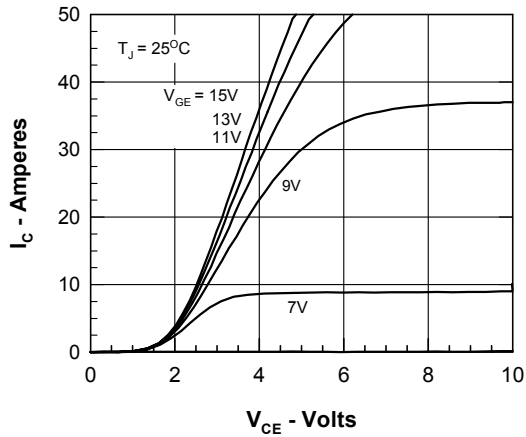

Fig. 2. Extended Output Characteristics

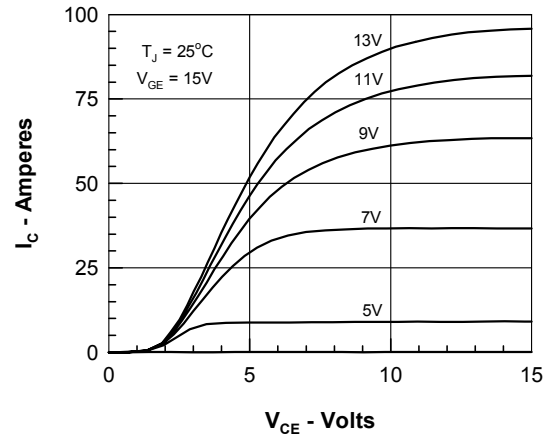

Fig. 3. Saturation Voltage Characteristics @ 125°C

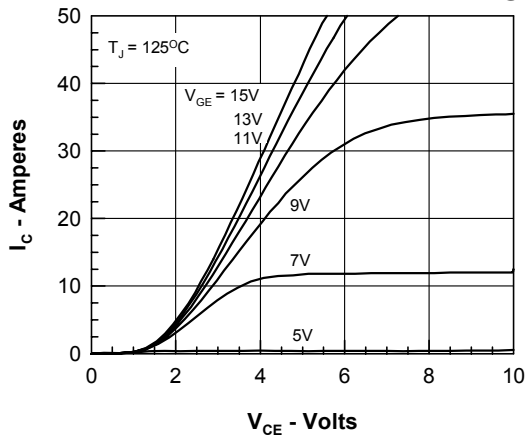

Fig. 4. Temperature Dependence of $V_{CE(SAT)}$

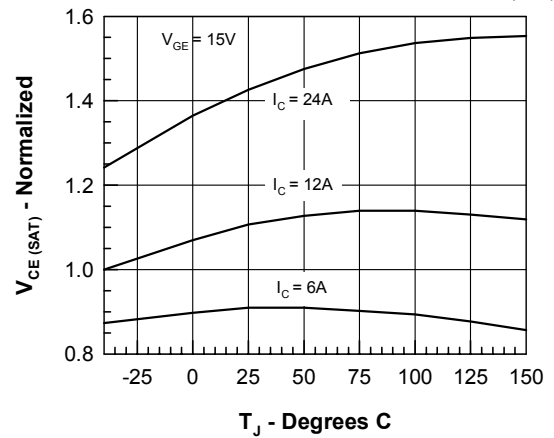

Fig. 5. Admittance Curves

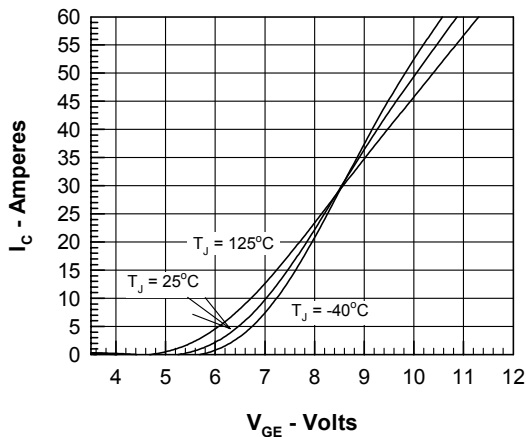

Fig. 6. Capacitance Curves

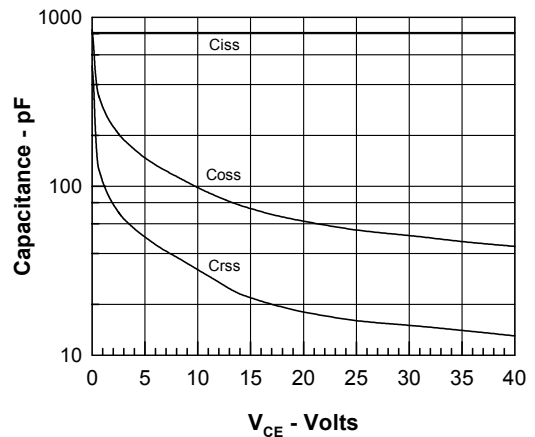

Fig. 7. Dependence of E_{OFF} on I_C

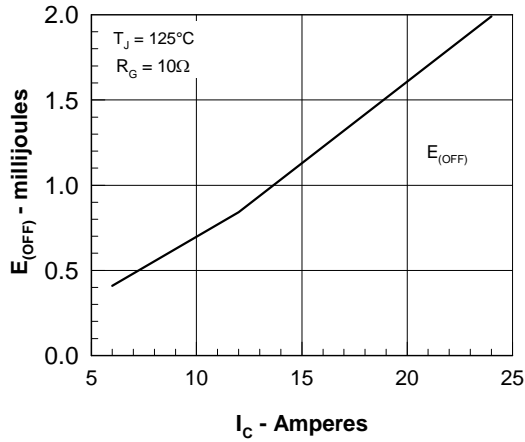

Fig. 8. Dependence of E_{OFF} on R_G

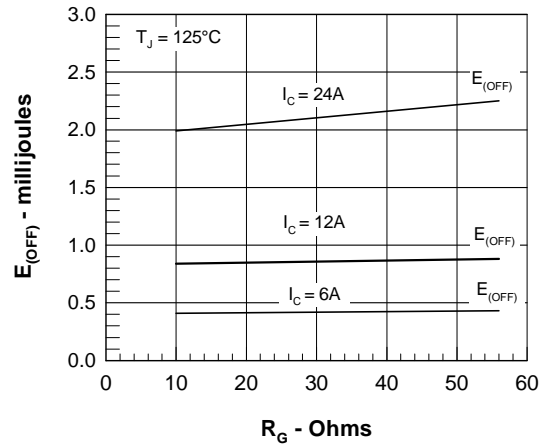

Fig. 9. Gate Charge

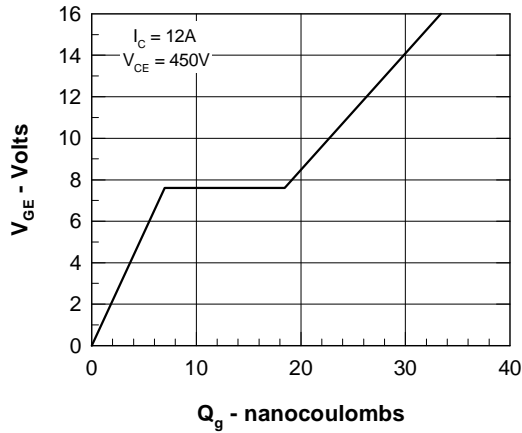

Fig. 10. Turn-off Safe Operating Area

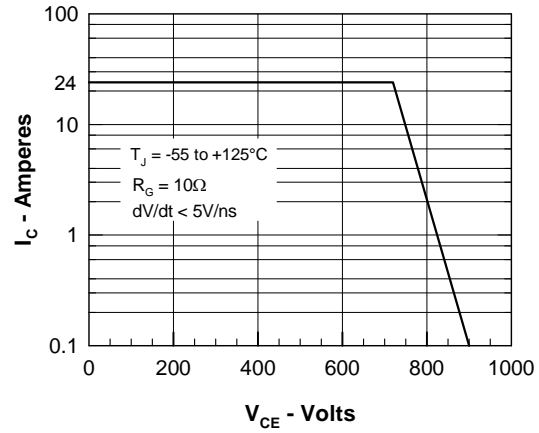
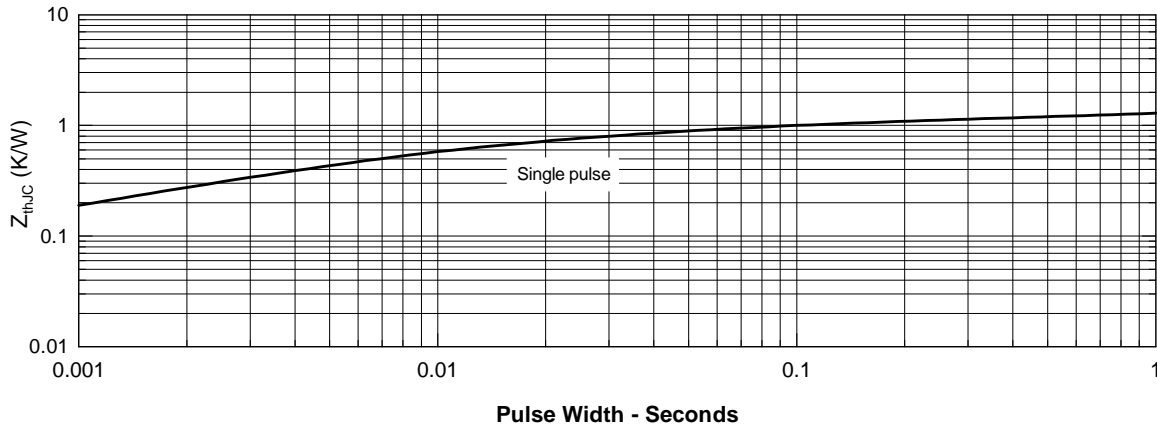

Fig. 11. Transient Thermal Resistance



IXYS reserves the right to change limits, test conditions, and dimensions.

IXYS MOSFETs and IGBTs are covered by one or more of the following U.S. patents:

4,835,592 4,881,106 5,017,508 5,049,961 5,187,117 5,486,715 6,306,728B1 6,259,123B1 6,306,728B1
4,850,072 4,931,844 5,034,796 5,063,307 5,237,481 5,381,025 6,404,065B1 6,162,665 6,534,343