



TDA2004

LINEAR INTEGRATED CIRCUIT

10+10W STEREO AMPLIFIER FOR CAR RADIO

DESCRIPTION

The UTC TDA2004 is a class B dual audio power amplifier and is designed for car radio applications.

FEATURES

- * Low distortion.
- * Low noise.

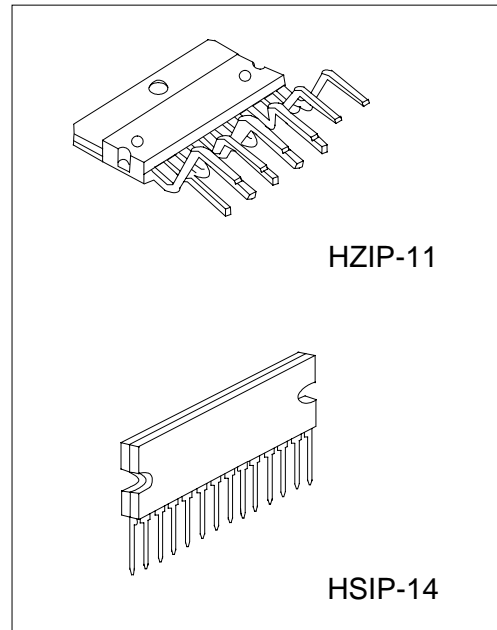

*Pb-free plating product number: TDA2004L

PIN DESCRIPTION

PIN NO.		PIN NAME
HZIP-11	HSIP-14*	
1	1	INPUT+ (1)
2	2	INPUT- (1)
3	3	SVRR
4	4	INPUT- (2)
5	5	INPUT+ (2)
6	6	GND
7	10	BOOTSTRAP 2
8	11	OUTPUT 2
9	12	+VS
10	13	OUTPUT 1
11	14	BOOTSTRAP 1

* PIN 7, 8, 9 no connection.

ORDERING INFORMATION

Ordering Number		Package	Packing
Normal	Lead Free Plating		
TDA2004-J11-T	TDA2004L-J11-T	HZIP-11	Tube
TDA2004-H14-T	TDA2004L-H14-T	HSIP-14	Tube

■ PIN CONFIGURATION

HZIP-11

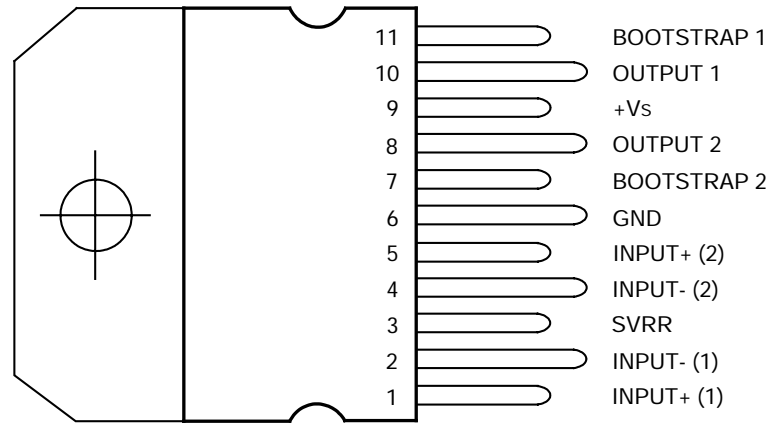

*TAB CONNECTED TO PIN 6

HSIP-14

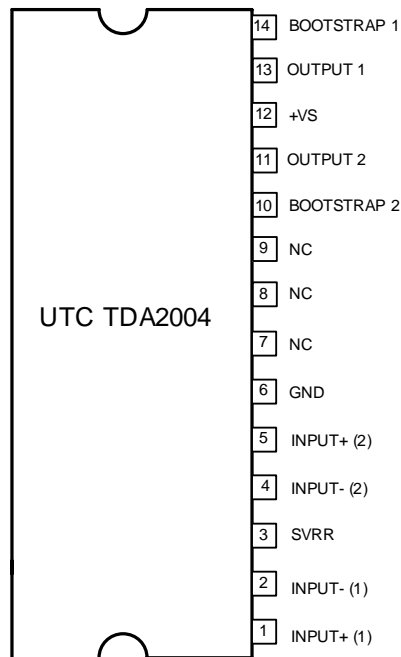

■ ABSOLUTE MAXIMUM RATINGS

PARAMETER	SYMBOL	RATINGS	UNIT	
Operating Supply Voltage	V _{SS}	18	V	
DC Supply Voltage	V _{SS}	28	V	
Peak Supply Voltage (for 50ms)	V _{SS}	40	V	
Output Peak Current	non repetitive t=0.1ms	I _O *	4.5	A
	repetitive f 10Hz	I _O *	3.5	A
Power Dissipation at T _c =60	P _D	30	W	
Junction Temperature	T _J	+125		
Storage Temperature	T _{STG}	-40 ~ 150		

* The max. output current is internally limited.

■ THERMAL DATA

PARAMETER	SYMBOL	RATINGS	UNIT
Thermal Resistance Junction-Case	J _C	3.0	/W

■ ELECTRICAL CHARACTERISTICS

(Refer to the test circuit, T_a=25 , G_v=50Db, R_{th}(heatsink)=4 /W, unless otherwise specified.)

PARAMETER	SYMBOL	TEST CONDITONS	MIN	TYP	MAX	UNIT
Supply Voltage	V _{SS}		8		18	V
Quiescent Output Voltage	V _{OUT}	V _{SS} =14.4V V _{SS} =13.2V	6.6 6.0	7.2 6.6	7.8 7.2	V
Total Quiescent Drain Current	I _D	V _{SS} =14.4V V _{SS} =13.2V		65 62	120 120	mA
Stand-by Current	I _{STAY-B}	Pin 3 grounded		5		mA
Output Power (each channel) f=1KHz, THD=10%	P _{OUT}	V _{SS} =14.4V R _L =4	6	6.5		W
		R _L =3.2	7	8		
		R _L =2	9	10*		
		R _L =1.6	10	11		
		V _{SS} =13.2V R _L =3.2	6	6.5		W
		R _L =1.6	9	10		
		V _{SS} =16V, R _L =2		12		W
Total Harmonic Distortion (each channel) f=1KHz	THD	V _{SS} =14.4V, R _L =4 P _{OUT} =50mW ~ 4W		0.2	1	%
		V _{SS} =14.4V, R _L =2 P _{OUT} =50mW ~ 6W		0.3	1	%
		V _{SS} =13.2V, R _L =3.2 P _{OUT} =50mW ~ 3W		0.2	1	%
		V _S =13.2V, R _L =1.6 P _{OUT} =50mW ~ 6W		0.3	1	%
Cross Talk	C _T	V _{SS} =14.4V V _{OUT} =4Vrms, R _L =4				
		f=1KHz f=10KHz, R _G =5K	50 40	60 45		dB dB
Input Saturation Voltage	V _{IN}		300			mV
Input Resistance (non inverting input)	R _{IN}	f=1kHz	70	200		k
Low Frequency Roll Off (-3dB)	f _L	R _L =4			35	Hz
		R _L =2			50	
		R _L =3.2			40	
		R _L =1.6			55	
High Frequency Roll Off (-3dB)	f _H	R _L =1.6 ~ 4	15			kHz

TDA2004

LINEAR INTEGRATED CIRCUIT

PARAMETER	SYMBOL	TEST CONDITONS	MIN	TYP	MAX	UNIT
Voltage Gain (open loop)	G _V	f=1kHz		90		dB
Voltage Gain (closed loop)		f=1KHz	48	50	51	dB
Closed Loop Gain Matching				0.5		dB
Total Input Noise Voltage	e _N	R _G =10k **		1.5	5	μV
Supply Voltage Rejection	SVR	f _{RIPPLE} =100Hz, R _G =10k C3=10 μF, V _{RIPPLE} =0.5Vrms	35	45		dB
Efficiency		V _{SS} =14.4V, f=1kHz R _L =4 , P _O =6.5W R _L =2 , P _O =10W		70 60		% %
		V _{SS} =13.2V, f=1kHz R _L =3.2 , P _O =6.5W R _L =1.6 , P _O =10W		70 60		% %
Thermal Shut-down Junction Temperature	T _J			145		

Notes: * 9.3W without Bootstrap

** Bandwith Filter: 22Hz ~ 22KHz.

■ TEST AND APPLICATION CIRCUIT

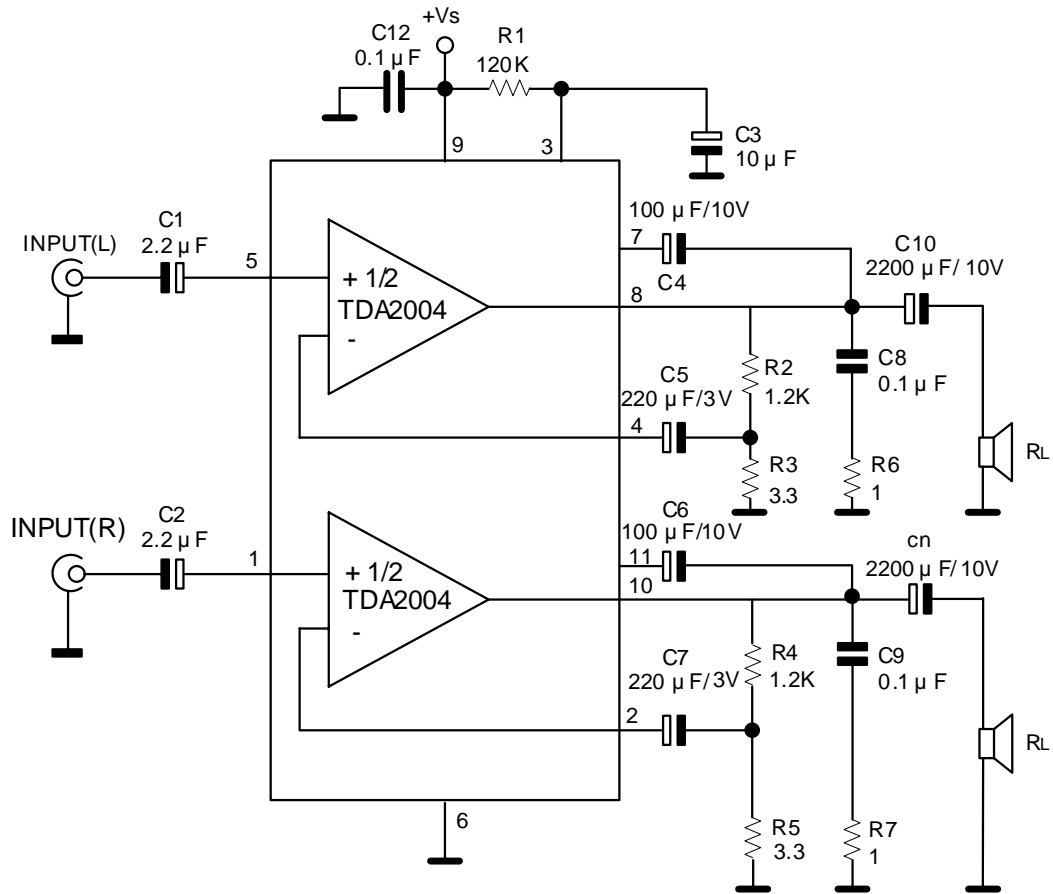

TYPICAL CHARACTERISTICS

Figure 1. Quiescent Output Voltage vs. Supply Voltage

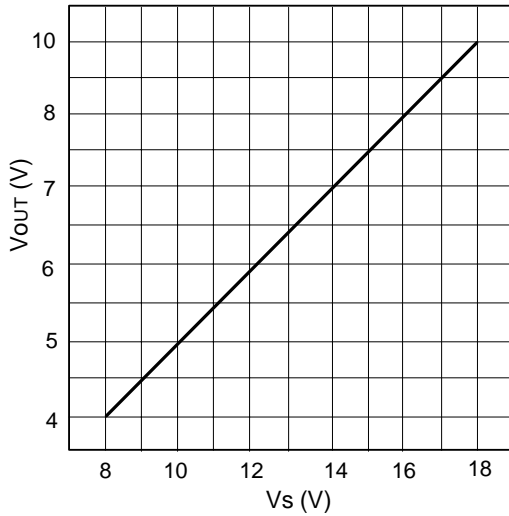

Figure 2. Quiescent Drain Current vs. Supply Voltage

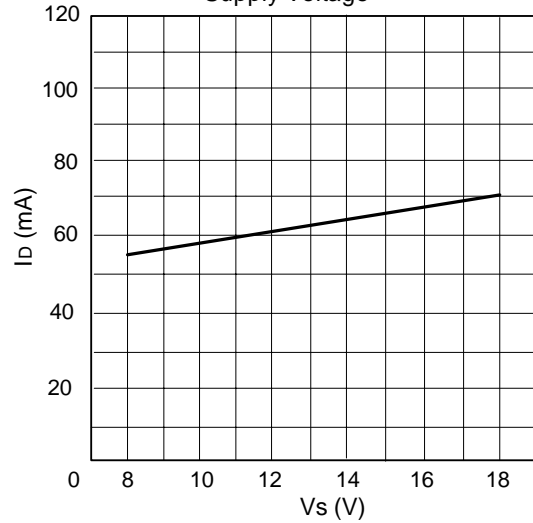

Figure 3. Distortion vs. Output Power

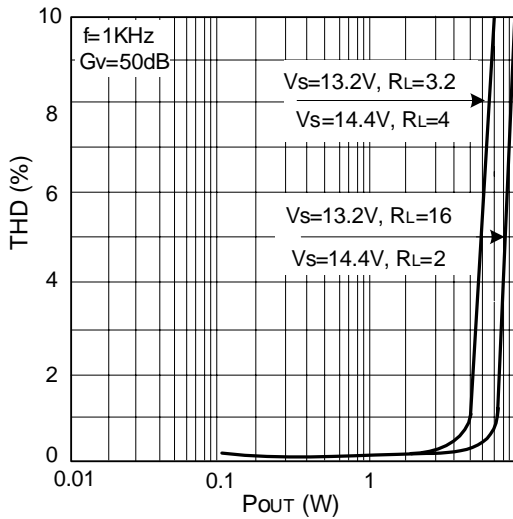

Figure 4. Output Power vs. Supply Voltage

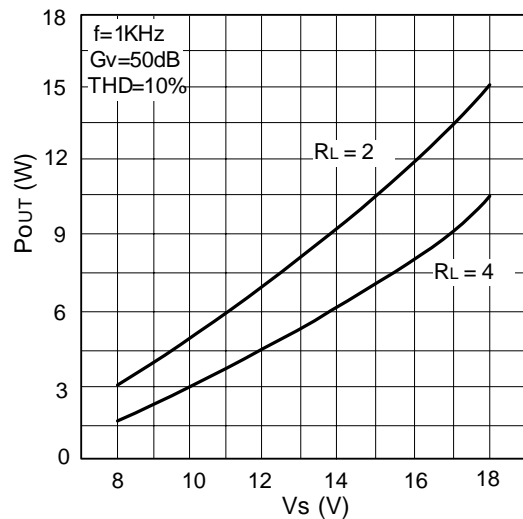

Figure 5. Output Power vs. Supply Voltage

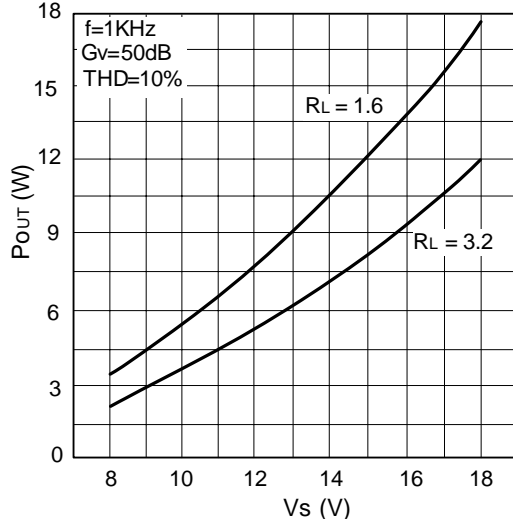
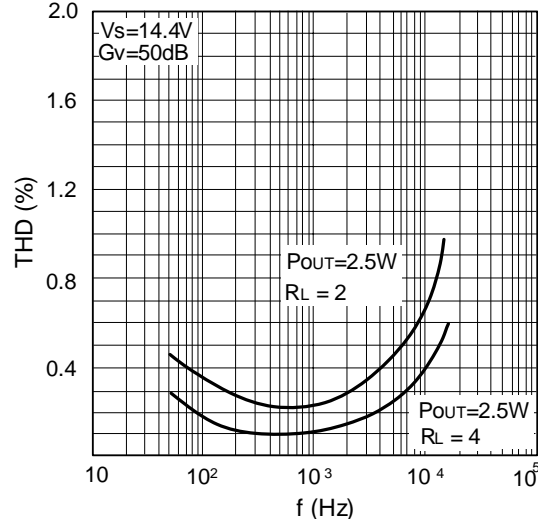
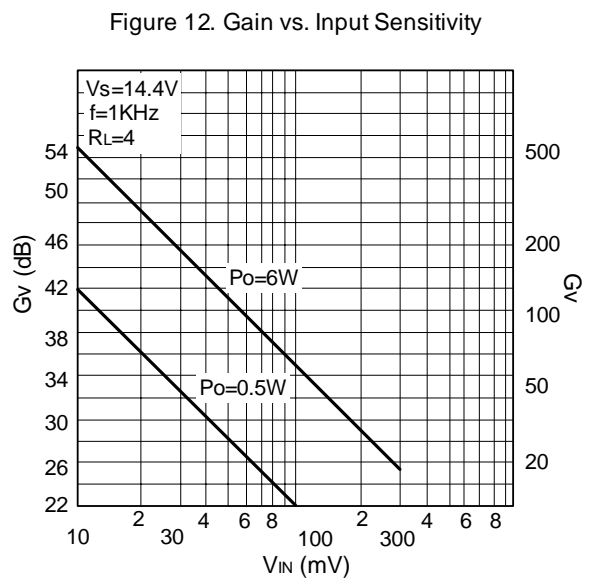
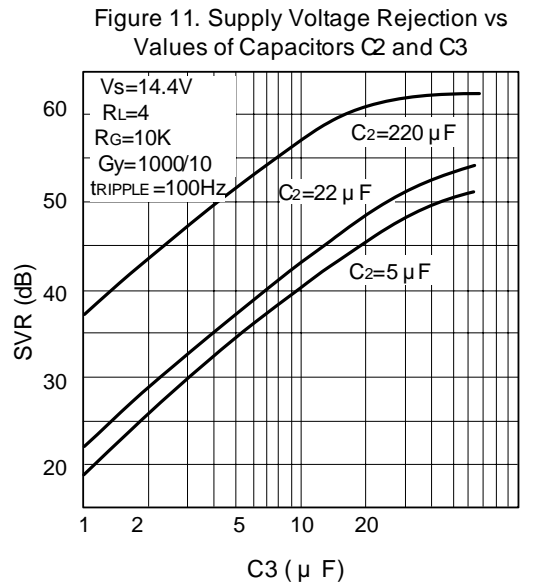
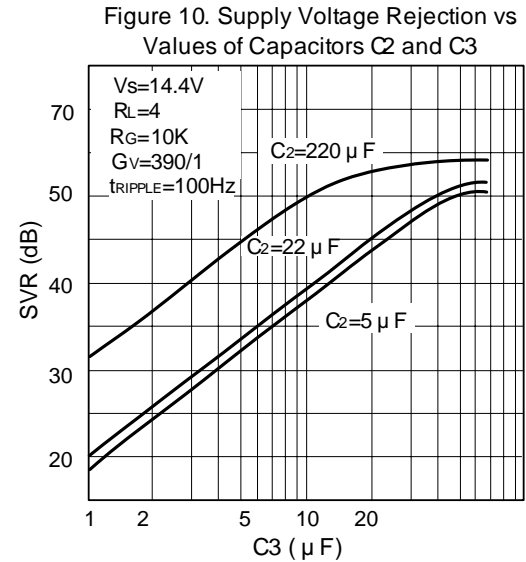
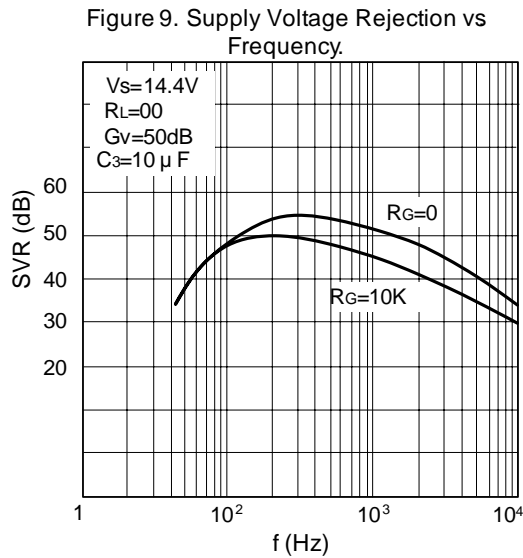
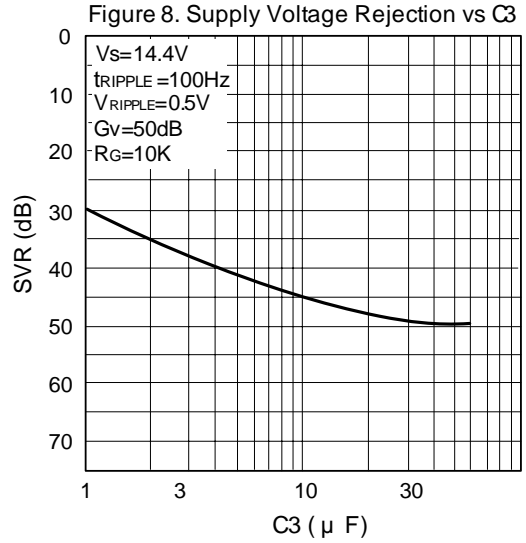
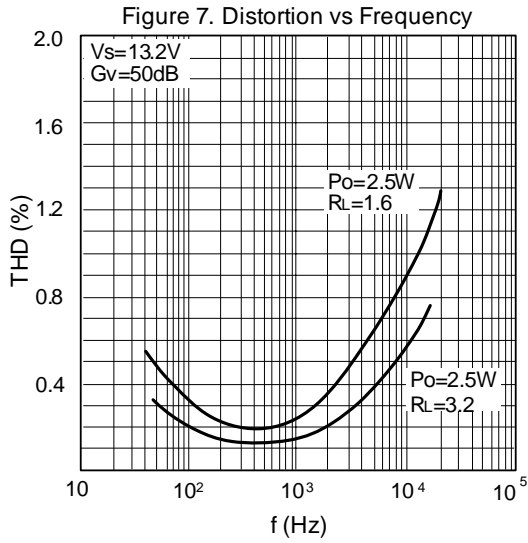

Figure 6. Distortion vs. Frequency



■ TYPICAL CHARACTERISTICS (cont.)



■ TYPICAL CHARACTERISTICS (cont.)

Figure 13. Maximum Allowable Power Dissipation vs. Ambient Temperature

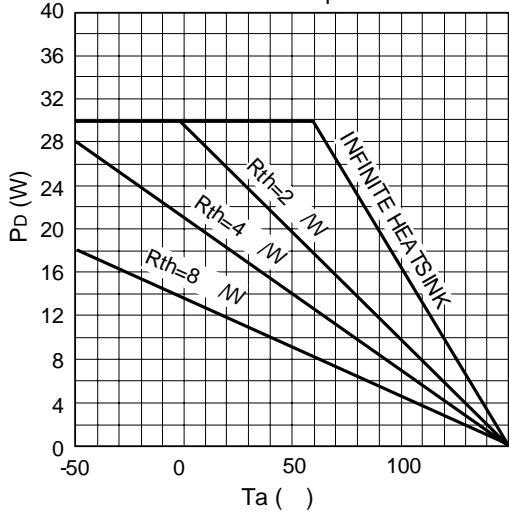

Figure 14. Total Power Dissipation and Efficiency vs. Output Power

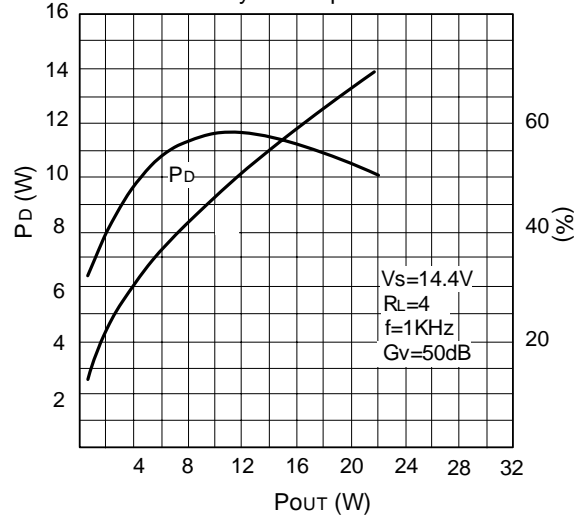
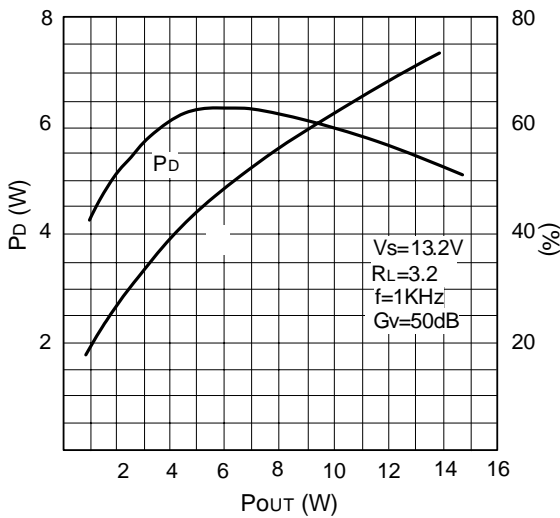

Figure 15. Total Power Dissipation and Efficiency vs. Output Power



UTC assumes no responsibility for equipment failures that result from using products at values that exceed, even momentarily, rated values (such as maximum ratings, operating condition ranges, or other parameters) listed in products specifications of any and all UTC products described or contained herein. UTC products are not designed for use in life support appliances, devices or systems where malfunction of these products can be reasonably expected to result in personal injury. Reproduction in whole or in part is prohibited without the prior written consent of the copyright owner. The information presented in this document does not form part of any quotation or contract, is believed to be accurate and reliable and may be changed without notice.